

ZOOM®

H3-VR

Handy Recorder

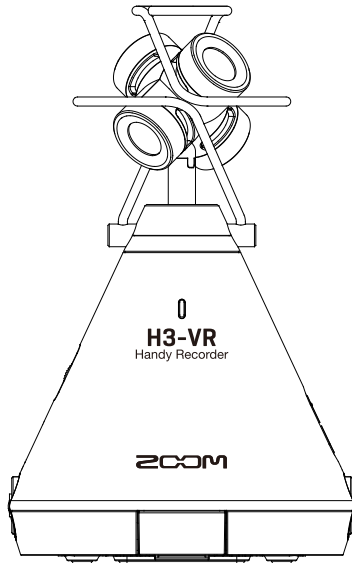

Quick Guide

You must read the Usage and Safety Precautions before use.



Download the Operation Manual from the ZOOM website (<https://www.zoom.jp/docs/h3-vr>).

This page has both PDF and ePub format files.

The PDF file format is suitable for printing and viewing on a computer.

The ePub file format is suitable for smartphones and tablets and can be read on electronic book readers.

© 2018 ZOOM CORPORATION

Copying or reprinting this manual in part or in whole without permission is prohibited.

Product names, registered trademarks and company names in this document are the property of their respective companies.

You might need this manual in the future. Always keep it in a place where you can access it easily.

The contents of this manual and the specifications of the product could be changed without notice.

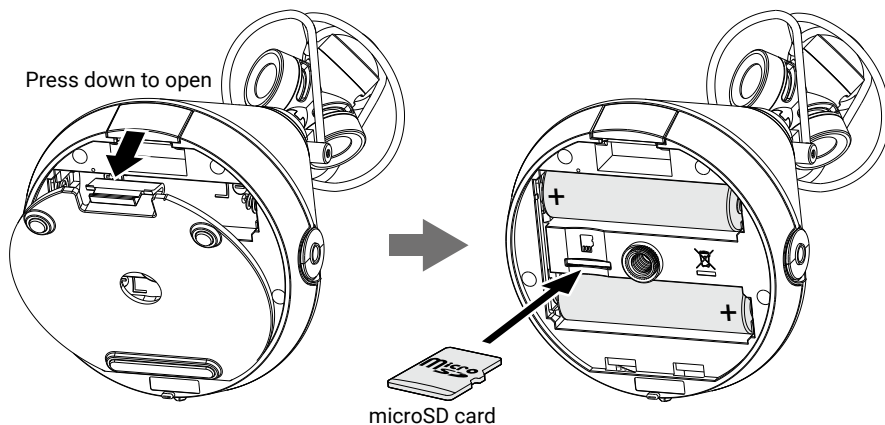

Preparations

1. Press the battery/microSD card compartment cover down to open it and insert batteries and a microSD card.





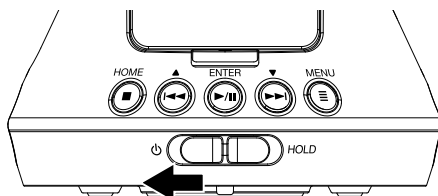

HINT

- An AC adapter (ZOOM AD-17) designed for use with this recorder can also be connected to the USB port to operate it using AC power.
- When connected to a computer, power can be supplied by USB.



2. Slide   HOLD toward  to turn the power on.



HINT



- To turn the power off, slide   HOLD toward .
- Sliding   HOLD to the HOLD side will disable button operations.



■ Setting the display language

Use  and  to select the display language, and press .



■ Setting the date and time

Selecting an item: Use  and  to select the item to change, and press .

Setting a value: Use  and  to change a value, and press .

Confirming the date and time: Use  and  to select OK, and press .

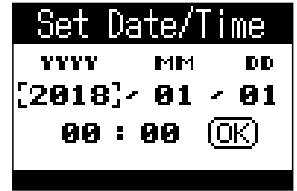

When setting the date and time is complete, the Home Screen will appear.

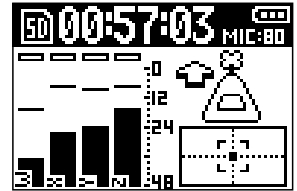

HINT

- Display language and date/time settings can also be changed later from a menu screen. To open the menu screen, press  while the Home Screen is open.





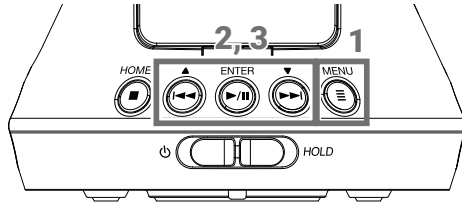

NOTE

- On the Battery menu screen, set the type of battery installed so that the amount of remaining battery charge can be accurately displayed.
- To format a microSD card, select SD card on the menu screen. After purchasing a new microSD card, always format it using the **H3-VR** to maximize performance.

Recording

Make recording settings



1. Press  when the Home Screen is open.
2. Use  and  to select the item to set, and press .
Press  to return to the original screen.
3. Use  and  to set each item.

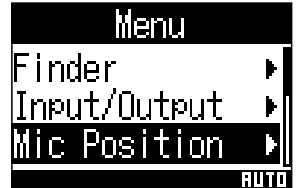

HINT

- By combining Ambisonic format files recorded with the **H3-VR** with video recorded using a 360° camera you can create videos that allow the audio to follow the visual perspective.
- Using software provided by ZOOM, you can convert files recorded with the **H3-VR** to a variety of formats, including stereo, 5.1ch surround, and binaural stereo.

■ **Setting items**

• **Setting the mic position: Mic Position**

The **H3-VR** can record sound in every direction, including forward, backward, left, right, up and down.

Use Mic Position to set the orientation of the mics and recorder in relation to the forward direction.

When Mic Position is kept at its default setting, the built-in motion sensor allows it to always record with normal forward/backward, left/right and up/down position relationships regardless of whether the mics are oriented up, down or forward.

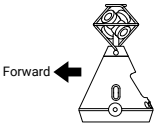
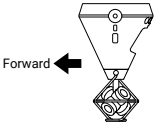
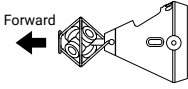
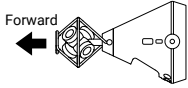
Setting	Mic/recorder orientation	Explanation
Auto	-	The H3-VR automatically sets the mic position according to its orientation at the start of recording.
Upright		Use this setting to record with the H3-VR upright.
Upside Down		Use this setting to record with the H3-VR upside down.
Endfire		Use this setting to record with the H3-VR oriented horizontally with its display up.
Endfire Invert		Use this setting to record with the H3-VR oriented horizontally with its display down.

The orientation of the **H3-VR** is detected by the motion sensor and shown on the Home Screen. Adjust the angle of the **H3-VR** so that the tilt indicator is centered.

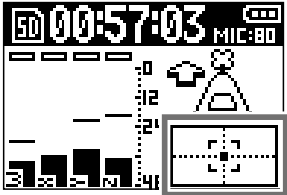

Tilt indicator

- **Setting the recording mode: Rec Settings ➔ Rec Mode**

This sets the file format used to record files.

Setting	Explanation
FuMa	Record as Ambisonics B FuMa format (4-channel).
AmbiX	Record as Ambisonics B AmbiX format (4-channel).
Ambisonics A	Record as Ambisonics A format (4-channel).
Stereo	Record as an ordinary stereo (2-channel) file.
Binaural	Record as a stereo (2-channel) file that has been converted to binaural.

- **Setting the recording format: Rec Settings ➔ Rec Format**

The recording format can be selected in consideration of audio quality and file size. Settings range from 44.1kHz/16-bit to 96kHz/24-bit. Higher values provide higher audio quality but also have larger file sizes.

- **Setting the Ambisonic monitoring mode: Input/Output ➔ Ambisonic Monitor**

This sets the conversion format when outputting Ambisonic input signals from the PHONE OUT and LINE OUT jacks.

Setting	Explanation
Stereo	The input sound is converted to ordinary stereo and output.
Binaural	The input sound is converted to binaural and output.

HINT

Use  VOLUME to adjust the headphone output volume.

- **Setting the low-frequency filter: Input/Output ➔ Lo Cut**

This function can reduce low-frequency noise, including air-conditioning, wind and vocal pops. This can be set from 10 to 240 Hz or Off.

- **Setting the limiter: Input/Output ➔ Limiter**

The limiter can prevent distortion by reducing loud input signals.

Setting	Explanation
On/Off	This turns the limiter on and off.
Threshold	The threshold for limiter operation can be set from -2 to -16 dBFS.
Attack Time	In a range from 1 to 4 ms, this sets the amount of time after the input signal exceeds the threshold until compression of the output signal is maximized.
Release Time	In a range from 1 to 500 ms, this sets the amount of time after the input signal goes below the threshold until the limiter stops compressing the signal.

Adjusting input levels (MIC GAIN)

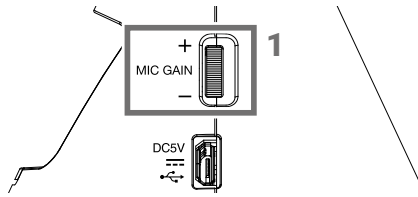

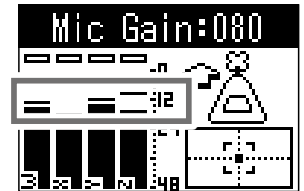

1. Turn MIC GAIN .

Adjust so that peak levels on the level meters stay around -12 dBFS.

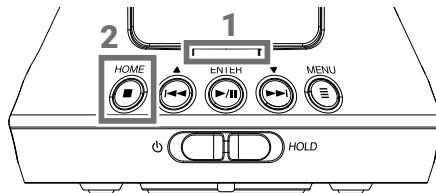

Recording



1. Press  when the Home Screen is open.

This shows the name of the recording file and starts recording.



2. Press .

This stops recording and opens the Home Screen.

■ Operations during recording

- **Pause:** Press .

This pauses recording. Marks are added automatically at points where recording has been paused.

- **Resume recording:** Press  again.

Playing recordings

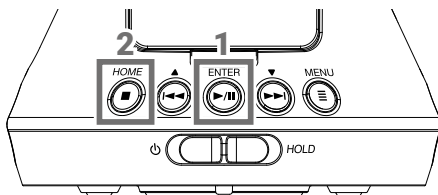

1. Press  when the Home Screen is open.
This shows the name of the file and starts playback.





HINT

Use  to adjust the headphone output volume.

2. Press .
- This stops playback and opens the Home Screen.

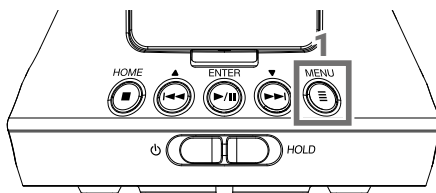
Changing the playback mode



1. Press  during playback.
Press repeatedly until the desired playback mode is selected.

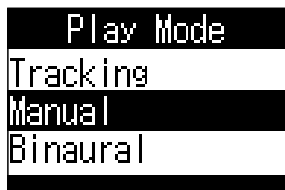

Tracking playback mode

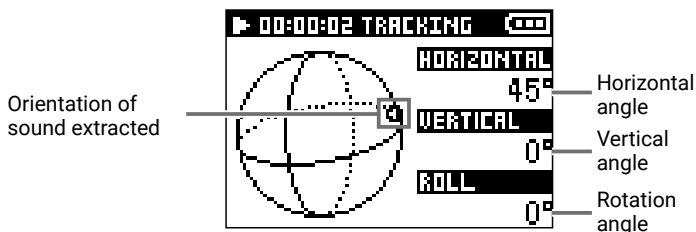

Stereo audio signals can be extracted according to specific orientations from files recorded in Ambisonics A and Ambisonics B (FuMa and AmbiX) formats.

The orientation of the extracted audio can be adjusted by changing the orientation of the **H3-VR**.



Manual playback mode

Stereo audio signals can be extracted according to specific orientations from files recorded in Ambisonics A and Ambisonics B (FuMa and AmbiX) formats.

The angle of the audio extracted can be adjusted by pressing  for the horizontal angle and pressing  for the vertical angle.

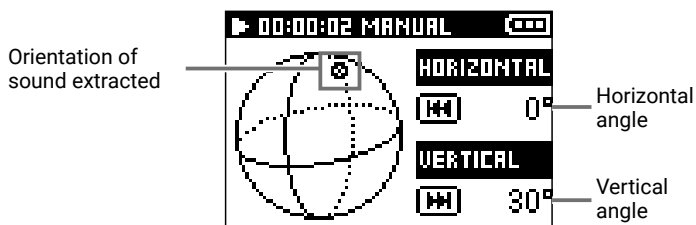





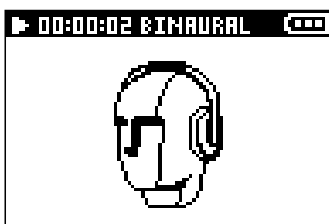

Binaural playback mode

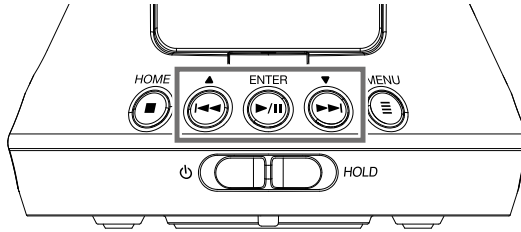
Files recorded in Ambisonics A and Ambisonics B (FuMa and AmbiX) formats can be converted to binaural.



Operations during playback





- Pause/resume playback: Press 
- Search forward: Press and hold 
- Search backward: Press and hold 
- Move to file beginning: Press 
- Play next file: Press 
- Play previous file: Press  twice

NOTE

When using manual playback mode, only  pause and resume playback functions can be used.

HINT

If marks have been added to the file playing back, pressing  and  will move to mark positions.

List of functions and settings







When the home screen is open, press  to open the MENU screen where you can use the following functions and settings.

Item	Explanation
Finder	This shows the folders and files on the microSD card.
Input/Output	Lo Cut This function can reduce noise, including air-conditioning, wind and vocal pops. (Off/10 – 240 Hz)
	Limiter The limiter can prevent distortion by reducing loud input signals.
	Ambisonic Monitor This sets how Ambisonic input sounds are monitored. (Stereo/Binaural)
	Line Out level This adjusts the line output level. (-40 dB – 0 dB) A test tone can be played in order to adjust the level of a digital SLR camera or other device.
Mic Position	This sets the mic orientation during recording. (Auto/Upright/Upside Down/Endfire/Endfire Invert)
Rec Settings	Rec Mode This sets the file format used to record files. (FuMa/AmbiX/Ambisonics A/Stereo/Binaural)
	Rec Format The recording format can be selected in consideration of audio quality and file size. (44.1k/16 bit – 96k/24 bit)
	Rec File Name This sets the file name used for recorded files. (Auto (Date)/User Defined Name)
	Sound Marker A tone signal (sound marker) can be output from the PHONE OUT and LINE OUT jacks when recording starts. (Off/On)





Item		Explanation
System	Date/Time	This sets the date/time and date display format. (YYMMDD/MMDDYY/DDMMYY)
	Time Display	Set how the counter appears on the display during recording and playback. (During recording: Elapsed Time/Remaining Time) (During playback: Elapsed Time/Remaining Time)
	LCD	The time until the display backlight turns off and the display contrast can be set. (Backlight: Off/On/30 sec/1 min/2 min/3 min/4 min/5 min) (Contrast: 1–10)
	Battery	Select the type of batteries used in the H3-VR . (Alkaline/Ni-MH/Lithium)
	SD card	The microSD card can be formatted and tested for performance.
	Versions	The firmware versions can be checked.
	Factory Reset	The factory default settings can be restored.
Language		This sets the language shown on the display.
USB	Audio I/F	H3-VR input signals can be input directly to a computer or iOS device, and playback signals on a computer or iOS device can be output from the H3-VR .
	Card Reader	Use a computer to check the files saved on the microSD card and copy those files to the computer.
BTA-1 (This menu item only appears when a BTA-1 is connected.)		Make this setting when a dedicated BTA-1 Bluetooth adapter is used to enable control of the H3-VR from an iOS device. (Off/On)

Connecting by USB

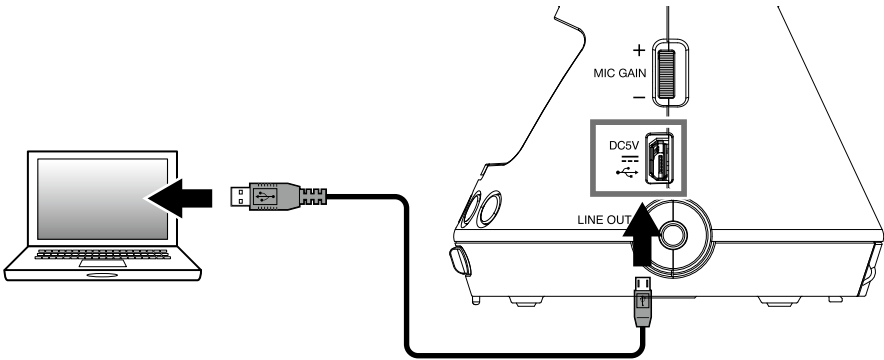









Using as an SD card reader

1. Press  when the Home Screen is open.
2. Use  and  to select "USB", and press .
3. Use  and  to select "Card Reader", and press .
4. Use a USB cable to connect the **H3-VR** and the computer.



5. When finished, end the USB connection from the computer.
6. Press  when the Home Screen is open.
7. Use  and  to select "Exit", and press .
8. Disconnect the USB cable from the **H3-VR** and the computer.





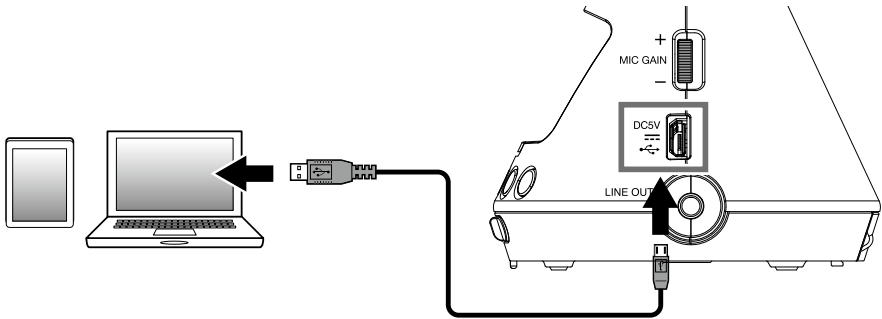

Using as an audio interface

1. Press  when the Home Screen is open.
2. Use  and  to select "USB", and press .
3. Use  and  to select "Audio I/F", and press .
4. Use  and  to select the mode or type of connected device, and press .

Setting	Explanation
Stereo	This sends a stereo mix of input signals 1–4 to the computer.
4ch Ambisonics	This sends tracks 1–4, which are converted from input signals 1–4, as separate signals to the computer.
Stereo (iOS)	This sends a stereo mix of input signals 1–4 to the iOS device.

5. Use a USB cable to connect the **H3-VR** with the computer or iOS device.



6. When finished with the USB connection, press  on the Home Screen.
7. Use  and  to select "Exit", and press .
8. Use  and  to select "Execute", and press .
9. Disconnect the USB cable from the **H3-VR** and the computer or iOS device.

HINT

- When connected to a computer, the recorder will operate on USB bus powered.
- Use batteries when connected to an iOS device.

Specifications

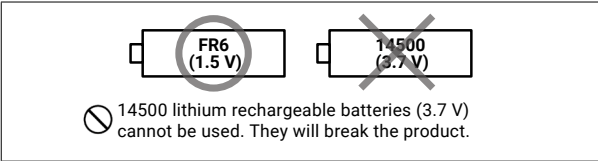
Recording media	Cards compatible with microSD/microSDHC/microSDXC specifications (Class 4 or higher)
Recording formats	<p>Ambisonics A, Ambisonics B (FuMa/AmbiX) WAV 4ch poly (supports BWF and iXML): 44.1 kHz/16-bit, 44.1 kHz/24-bit, 48 kHz/16-bit, 48 kHz/24-bit, 96 kHz/16-bit, 96 kHz/24-bit</p> <p>Stereo WAV stereo (supports BWF and iXML): 44.1 kHz/16-bit, 44.1 kHz/24-bit, 48 kHz/16-bit, 48 kHz/24-bit, 96 kHz/16-bit, 96 kHz/24-bit</p> <p>Binaural WAV stereo (supports BWF and iXML): 44.1 kHz/16-bit, 44.1 kHz/24-bit, 48 kHz/16-bit, 48 kHz/24-bit</p>
Display	1.25" monochrome LCD (96×64)
Motion sensor	6 axes (3-axis gyro, 3-axis acceleration)
Built-in Ambisonic mic	4 matched unidirectional condenser mics Maximum sound pressure input: 120 dB SPL Mic gain: +18 – +48 dB
LINE OUT	Connector: 3.5 mm stereo mini Maximum output level: -10 dBu (1 kHz, 10 kΩ load)
PHONE OUT	Connector: 3.5 mm stereo mini Maximum output level: 20 mW + 20 mW (into 32Ω load)
USB	Connector: microUSB <u>Mass storage operation</u> USB 2.0 High Speed <u>Audio interface operation</u> 2 in/2 out (stereo/binaural input), USB 2.0 Full Speed 44.1 kHz/16-bit, 48 kHz/16-bit 4 in/2 out (Ambisonics A/FuMa/AmbiX input), USB 2.0 High Speed 44.1 kHz/24-bit, 48 kHz/24-bit
Power	2 AA batteries (alkaline, rechargeable NiMH or lithium) AC adapter (ZOOM AD-17): DC 5V/1A (supports USB bus power)
Estimated continuous recording time using batteries	48 kHz/24-bit, FuMa Rec Mode Alkaline batteries: about 11.5 hours NiMH batteries (1900 mAh): about 11.5 hours Lithium batteries: about 24 hours
	
<ul style="list-style-type: none"> • The above values are approximate. • Continuous battery operation times were determined using in-house testing methods. They will vary greatly according to use conditions. 	
External dimensions	76 mm (W) × 78 mm (D) × 123 mm (H)
Weight (main unit only)	120 g

Google Spatial Audio HRIRs
 Copyright 2016 Google Inc. All Rights Reserved.
 This product includes HRTFs (head related impulse responses) developed by Google Inc.
 Google Spatial Audio is released under Apache License 2.0.



ZOOM CORPORATION

4-4-3 Kanda-surugadai, Chiyoda-ku, Tokyo 101-0062 Japan
www.zoom.co.jp