

© ZOOM Corporation
 Reproduction of this manual, in whole
 or in part, by any means, is prohibited.

RFX-1100

DIGITAL REVERB & MULTI EFFECTS OPERATION MANUAL

Introduction

Thank you for selecting the ZOOM RFX-1100 (hereafter simply called the "*RFX-1100*"). The RFX-1100 is a sophisticated digital reverb and multi-effect processor with the following features and functions.

- **33 immediately usable effects**
 The RFX-1100 comes with a full complement of preset effects (11 effects x 3 banks). Right out of the box, the unit is ready to create great sound. The REVERB bank in particular provides a wide spread and natural sounding ambience that meets even demanding professional standards.
- **Built-in professional quality reverb**
 The reverb effects alone allow 121 different settings. The convincing sound stage created by the RFX-1100 far surpasses anything else available in this class.
- **Innovative choices**
 Lo-Fi EFX purposely degrades sound quality for special effect. RESONANCE processes the input signal with sophisticated filtering. MIC SIMULATOR produces condenser mic sound from a dynamic microphone. These and various other effects are great for recording and give full scope to your creativity.
- **Attractive mixdown effects**
 Mixdown effects can be used effectively to tailor the overall mood of a song when performing mixdown (mixing multiple tracks onto two final stereo tracks) or mastering (fine-tuning the sound and level of a final 2-track mix).
- **Intuitive editing controls**
 Convenient knobs on the front panel let you directly adjust items such as the mixing ratio of original sound and effect sound. Editing effect parameters on the fly is also easy and straightforward. This allows quick fine-tuning for optimum sound.
- **MIC IN connector**
 The MIC IN connector on the front panel serves as an additional input for a microphone. This is convenient for applying effects to a vocal part and for controlling the VOCODER effect with your voice.

Please take the time to read this manual carefully so as to get the most out of your RFX-1100 and to ensure optimum performance and reliability. Retain this manual, the warranty card and all other documentation for future reference.

Contents

Controls and Functions	2
Front Panel	2
Rear Panel	2
Rack Mounting	4
Getting Connected	4
Trying Out the Effects	6
Changing the Sound of an Effect	7
RFX-1100 Effects	8
Troubleshooting	15
Specifications	15
Safety Precautions/Usage Precautions	

Controls and Functions

Front Panel

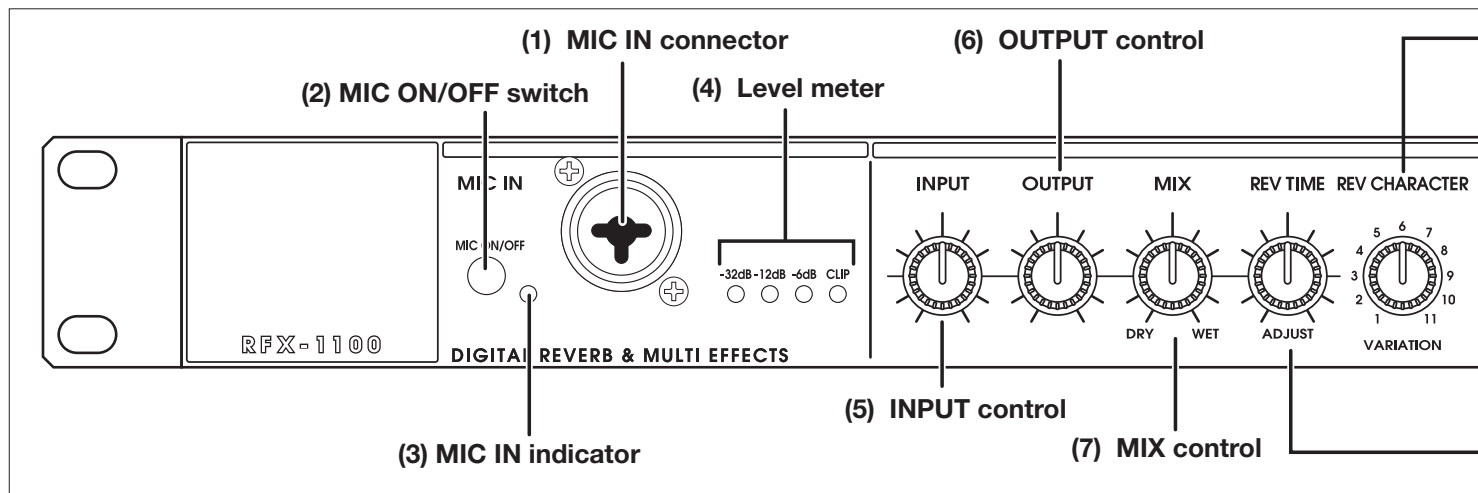

(1) MIC IN connector

A dynamic microphone with an impedance of about 600 ohms can be connected here, for use as an additional input source. Either an XLR plug (balanced connection) or a phone plug (balanced/unbalanced connection) can be used.

Normally the input signal from this connector is mixed with the signal from the rear-panel INPUT jacks. When the VOCODER effect is selected, the signal from this connector serves for controlling the sound character and the envelope (volume change curve) of the VOCODER effect.

(2) MIC ON/OFF switch

This switch turns the signal from the MIC IN connector on and off.

* Before inserting or removing the plug of a microphone into and from the MIC IN connector, be sure to set the MIC ON/OFF switch to OFF.

(3) MIC IN indicator

When the MIC ON/OFF switch is ON, this indicator lights up.

(4) Level meter

These indicators show the signal input level.

(5) INPUT control

Serves to adjust the signal from the INPUT jacks and the MIC IN jack.

(6) OUTPUT control

Serves to adjust the level of the signal supplied at the OUTPUT jacks.

(7) MIX control

Serves to adjust the balance between original sound (DRY) and effect sound (WET). When the control is turned fully counterclockwise, only the original sound is output. When the control is turned fully clockwise, only the effect sound is output.

Rear Panel

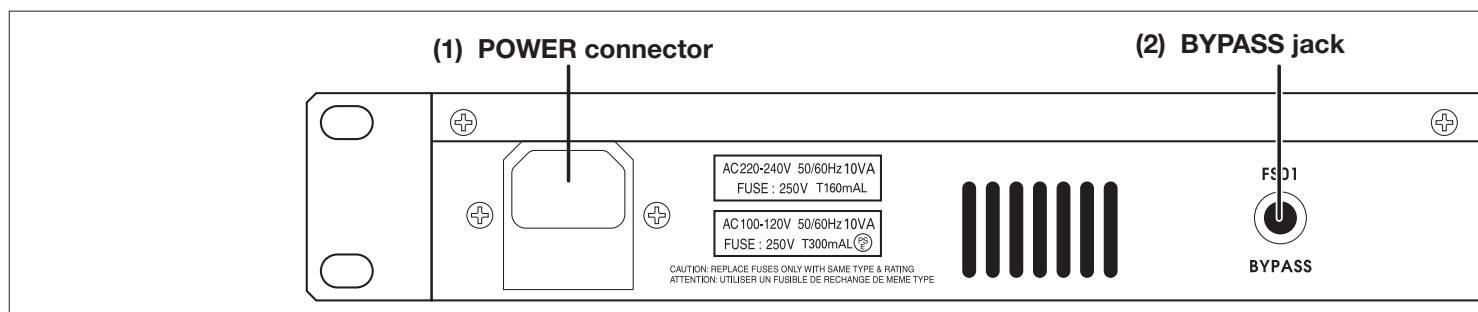

(1) POWER connector

The supplied power cable is to be connected here for powering the unit.

(2) BYPASS jack

Serves for connection of the foot switch FS01 (option) for switching effects on and off.

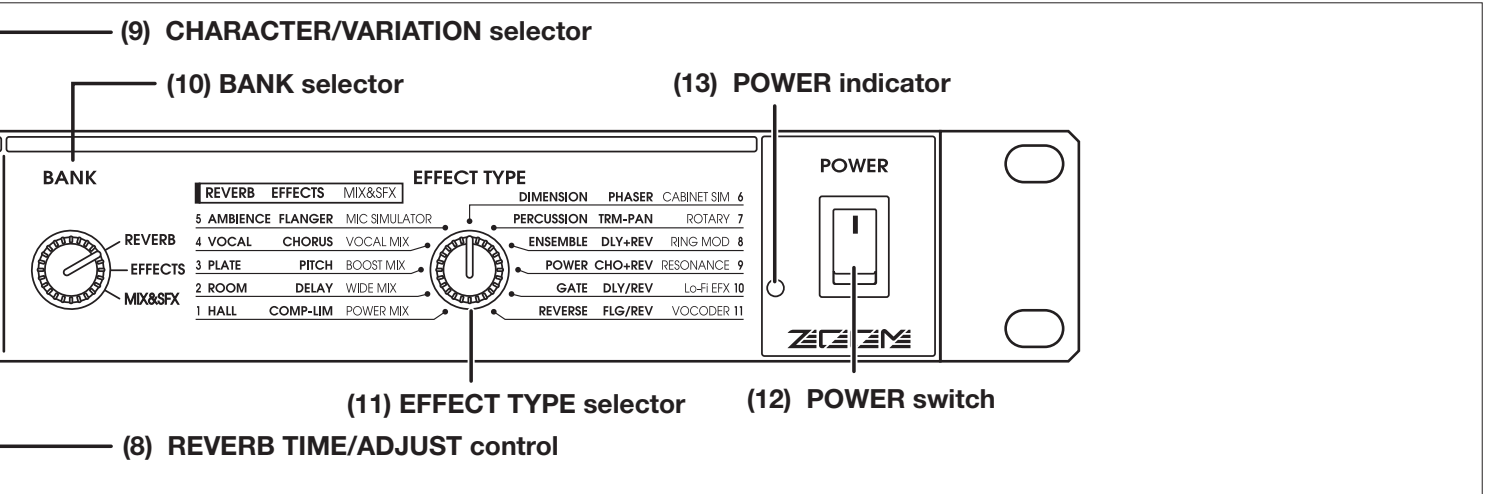

(8) REVERB TIME/ADJUST control

Serves to adjust an effect parameter of the currently selected effect.

(9) CHARACTER/VARIATION selector

Serves to choose one of 11 character settings for the currently selected effect, or to adjust an effect parameter.

(10) BANK selector

Serves to select the effect bank (group of effects). The following three effect banks are available.

- **REVERB bank**
Contains various reverb effects.
- **EFFECTS bank**
Contains single effects for instruments and voice, and combined effects.

• MIX&SFX bank

Contains special effects and effects particularly suited for mixdown (mixing multiple tracks onto two final stereo tracks).

(11) EFFECT TYPE selector

Serves to choose an effect from the currently selected bank.

(12) POWER switch

Serves to turn the unit on and off.

(13) POWER indicator

When the RFX-1100 is on, this LED indicator is lit in green. When the foot switch FS01 (option) was used to switch the effects off, the indicator flashes red.

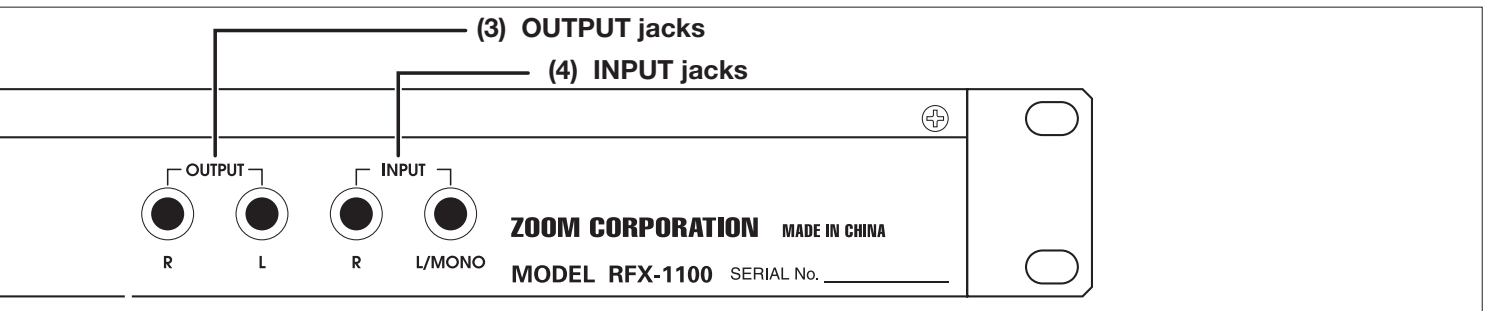

(3) OUTPUT jacks

Connect these jacks to the recorder or playback system.

(4) INPUT jacks

Connect a line-level source, such as an instrument or

the send output of a mixer, to these jacks. If a plug is inserted only in the L/MONO jack, the signal from this plug will be supplied to both channels. A high-impedance source such as an electric guitar should be routed through a preamplifier or a guitar effect first.

Rack Mounting

The RFX-1100 is compatible with international 19-inch rack standards (EIA, DIN). Because the unit has been designed for rack installation, it is preferable to operate the unit in this way, rather than simply placing it on a table or similar. Align the four screw holes with the rack screw holes and securely fasten the unit to the rack with screws.



- The RFX-1100 uses a metal frame, making the unit heavier than it might seem at first glance. While installing the unit in a rack, carefully support the weight of the unit until all screws are securely tightened. Otherwise the unit may drop, possibly causing injury to persons or damage to itself or to other equipment.
- Do not directly stack the unit on top of other equipment. Otherwise heat may lead to a fire risk or cause performance degradation.
- Before installation, always unplug any connecting cables and the power cable. Otherwise the equipment or the cables may be damaged.
- Make sure that the rack in which the unit is installed is placed on a firm, solid surface, so that it cannot shake or topple over. Otherwise there is a risk of injury to persons or damage to the unit or to other equipment.

Getting Connected

Basic Connections

RFX-1100 is connected to an electronic instrument, microphone, and mixer or other audio device

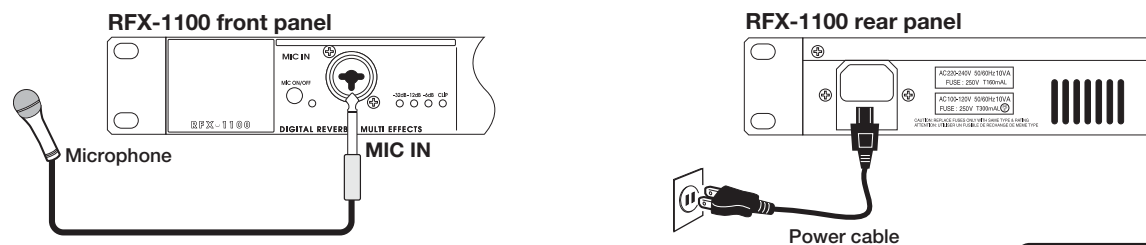

Always turn the power to all components off before making any connections. Otherwise there is a risk of hearing damage or equipment damage by sudden loud noise.

Insert Connection

This is an example for inserting the RFX-1100 between the sound source and a playback system or multi-track recorder (MTR). A stereo source should be connected to the INPUT L/MONO and R jacks. A mono source should be connected to the L/MONO jack only.

In this example, the signal from the mic or the instrument is effect processed by the RFX-1100 and then sent to the playback system or MTR. The balance between original sound and effect sound is adjusted at the RFX-1100.

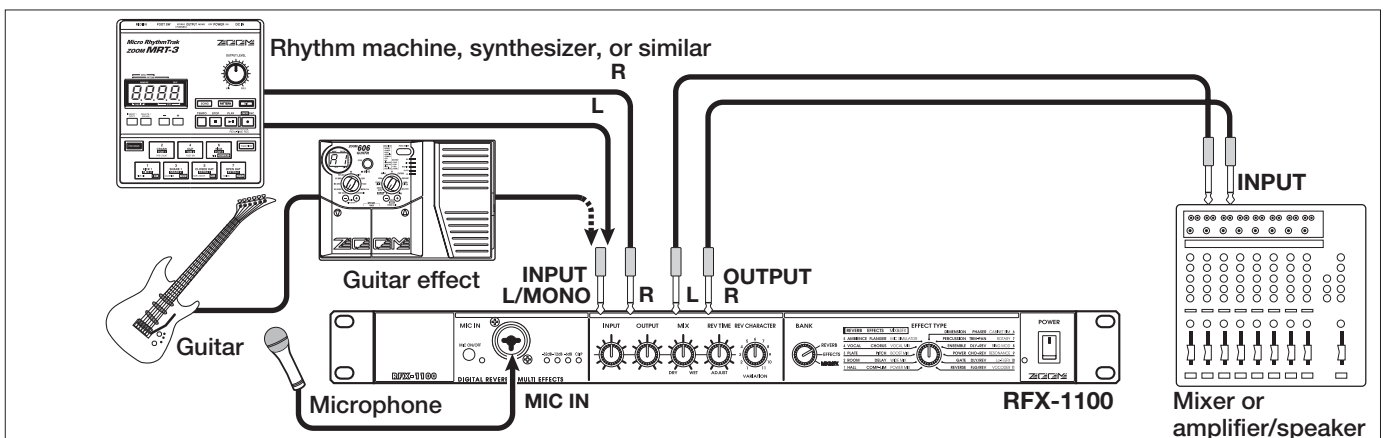

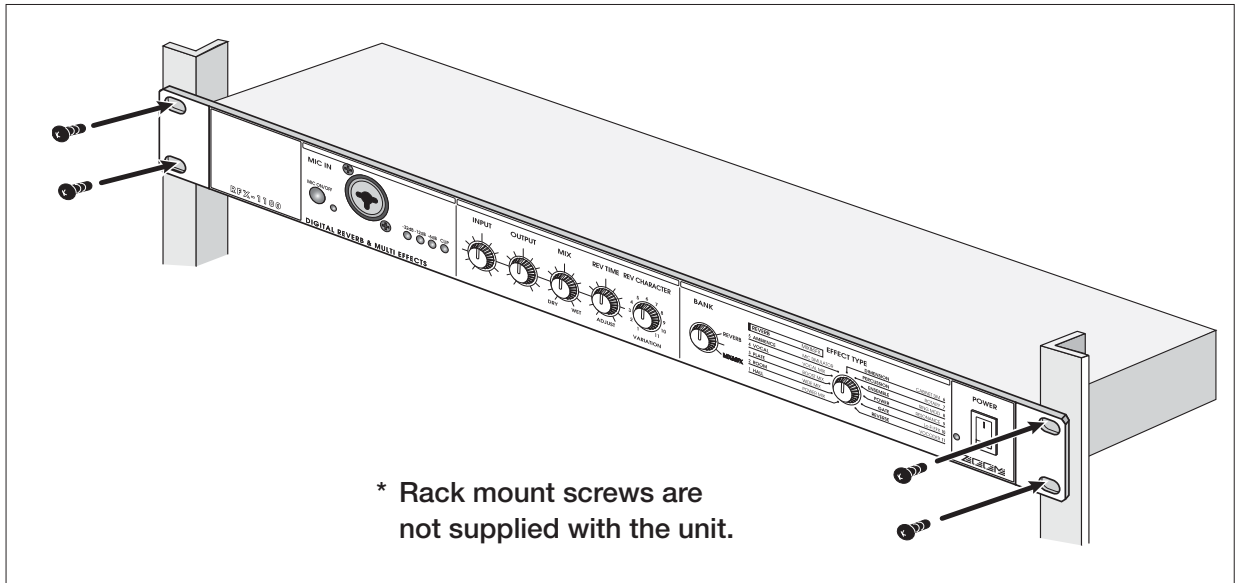

Getting Connected

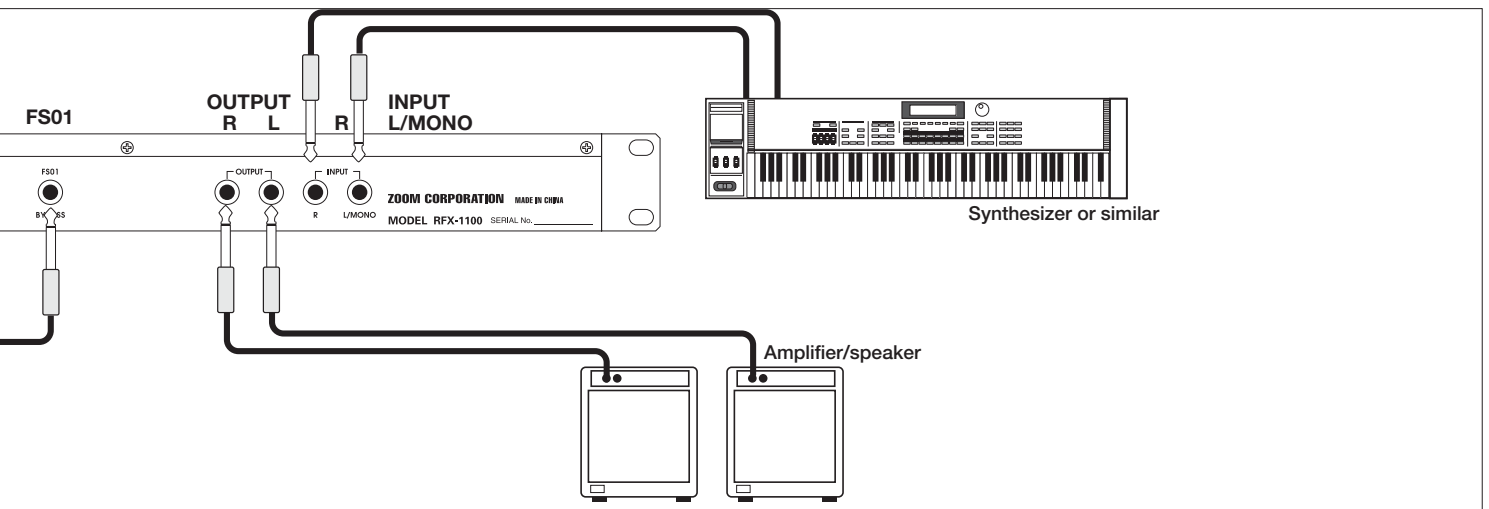

Send/Return Connection

This is an example for connecting the RFX-1100 to the send/return jacks of a mixer or multi-track recorder. Connect the send jack of the mixer or MTR to the INPUT L/MONO jack of the RFX-1100, and connect the OUTPUT L/R jacks of the RFX-1100 to the return jacks (or the stereo line input jacks) of the mixer or MTR.

In this configuration, the RFX-1100 should be set so that it outputs only the effect sound, and the balance between original sound and effect sound should be adjusted at the mixer or multi-track recorder. Supplying the send signal to the RFX-1100 in stereo is also possible.

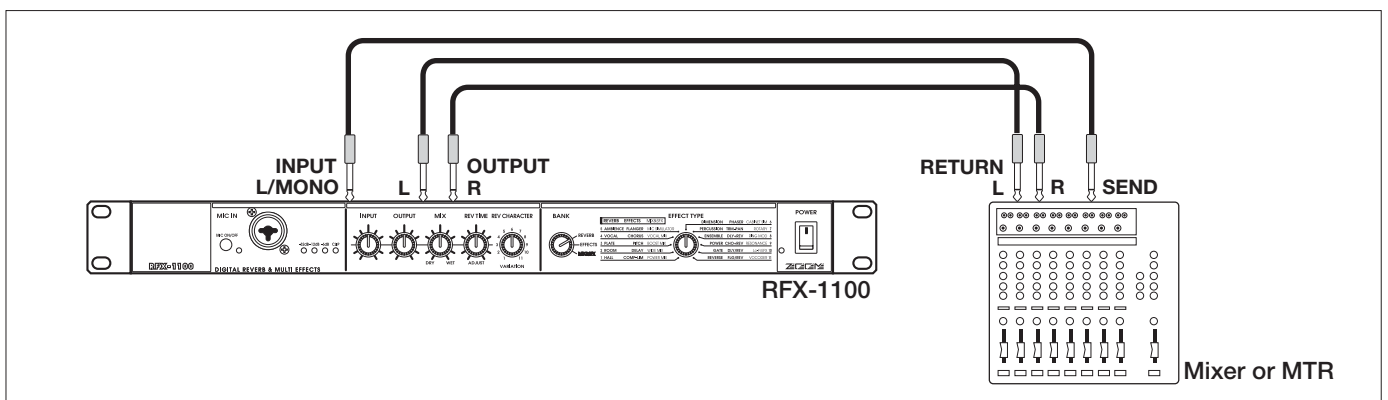

Using the VOCODER Effect

This is a connection example for using the VOCODER effect from the MIX&SFX bank. Connect a dynamic microphone to the front-panel MIC IN jack on the RFX-1100. Connect a synthesizer or other instrument to the rear-panel INPUT L/MONO jack. You can then use the mic to vary the envelope (volume change curve) and the sound character of the VOCODER effect. Instead of the mic, it is also possible to use the right-channel signal for controlling the effect. In this case, the signal supplied to the INPUT L/MONO jack is controlled by the signal supplied to the INPUT R jack. Verify that the MIC IN indicator is lit. If not, press the MIC ON/OFF switch so that the indicator comes on.

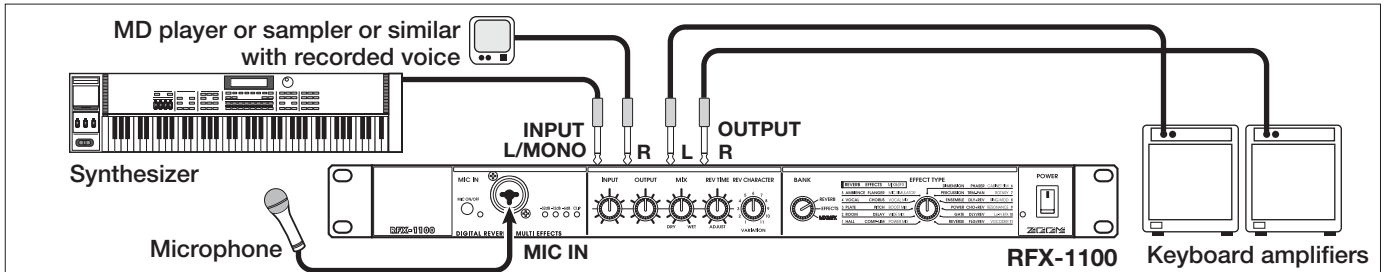

Using Two Effects in Parallel

The RFX-1100 allows using two effects at the same time (in parallel). This is possible with effects from the EFFECTS bank which have a double name separated with a slash ("/"). The following illustration shows a connection example for using two effects independently in the left and right channel.

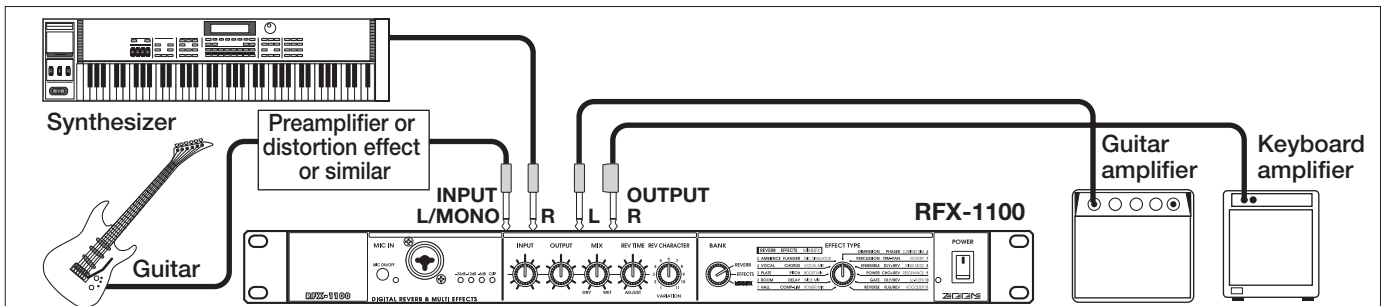

Trying Out the Effects

1. Verify that the AC cable, sound source, and playback system are correctly connected to the RFX-1100.

The INPUT control and OUTPUT control of the RFX-1100 as well as the volume control of the playback system should be set to minimum.

2. Turn on the system in the following order: sound source → RFX-1100 → playback system.

3. While playing the sound source, turn up the INPUT control of the RFX-1100 to adjust the input level.

To minimize noise and distortion, the INPUT control should be set as high as possible without causing the CLIP LED to light.

4. Adjust the OUTPUT control and the volume control of the playback equipment to obtain a suitable playback volume.

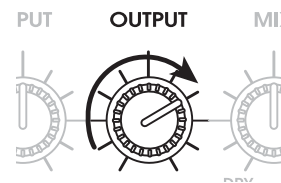

5. Use the BANK selector and the EFFECT TYPE selector to select the desired effect.

Depending on the position of the BANK selector, the available effects are as shown below.

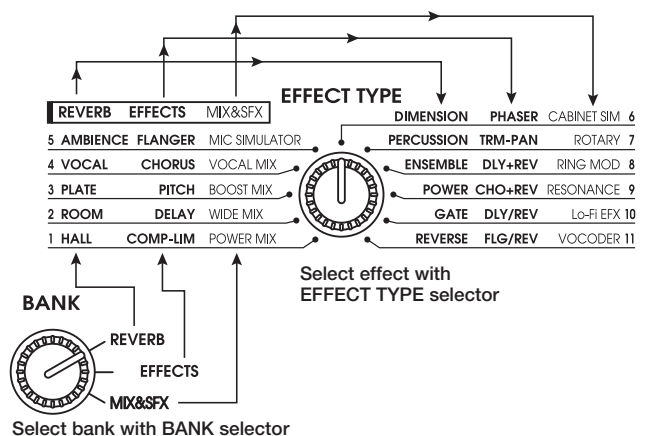

Changing the Sound of an Effect

The following controls are available for changing the sound character and intensity of the preset effects of the RFX-1100 and for adjusting the balance between original sound and effect sound.

(1) MIX control

Adjusts the mixing balance between the original sound and the effect sound.

• When using the insert type connection pattern

Use the MIX control to adjust the mixing balance between original sound (DRY) and effect sound (WET).



For effects such as compressor/limiter or microphone simulator where the output is the processed original sound, turn the MIX control fully to WET.



• When using the send/return type connection pattern

The MIX control should be turned fully to WET, so that only the effect sound is output. The mixing balance between original sound and effect sound should be adjusted at the mixer or multi-track recorder.

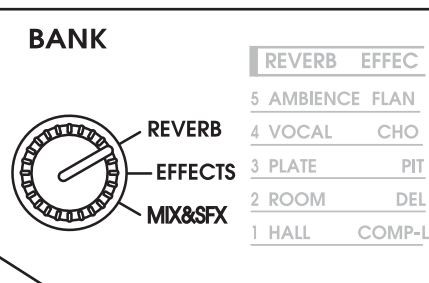
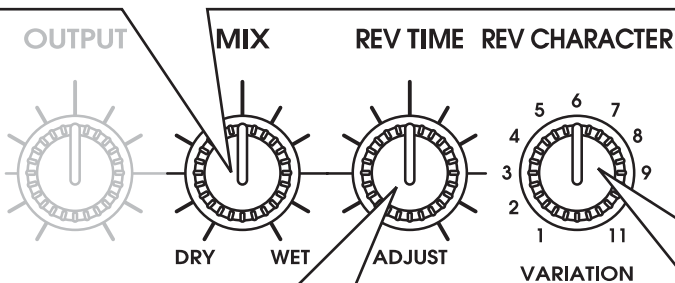
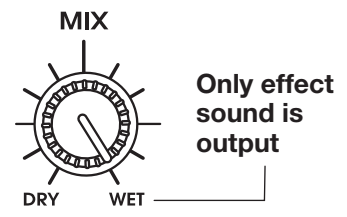

(2) REVERB TIME/ADJUST control

The function of this control differs, depending on which effect bank is currently selected with the BANK switch.

• REVERB bank selected with BANK selector



The control adjusts the reverb duration.

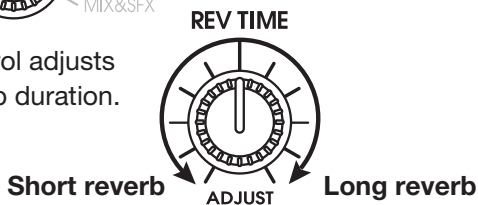

• EFFECTS/MIX&SFX bank selected with selector



The control adjusts a major parameter of the currently selected effect.

For information on which parameters can be adjusted for each effect, see pages 8 - 15.

(3) CHARACTER/VARIATION selector

The function of this selector differs, depending on which effect bank is currently selected with the BANK switch.

• REVERB bank selected with BANK selector



The selector can be used to choose one of 11 reverb sound characteristics (settings with different tone and intensity).

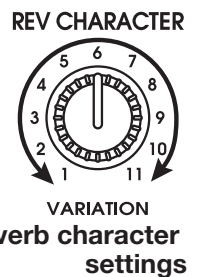

• EFFECTS/MIX&SFX bank selected with selector

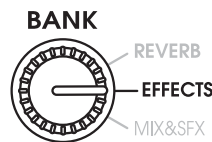

The control adjusts a major parameter of the currently selected effect.

For information on which parameters can be adjusted for each effect, see pages 8 - 15.













RFX-1100 Effects













This section lists all the effects available in the RFX-1100 and describes the character or parameter variations that are possible.



Effects suitable for a send/return connection are marked with the  symbol.

• REVERB Bank

This bank contains a variety of reverb effects. For effects 1 - 9, the CHARACTER control can be used to select one of eleven character variations.

1. HALL		These effects simulate the reverb in various types of medium to large size buildings.	
CHARACTER		REVERB TIME	Recommended setting
1	Large Hall	Simulates a large concert hall.	
2	Bright Hall	Simulates a medium-size hall with strong, bright reverb.	
3	Recital Hall	Simulates a small hall.	
4	Municipal	Simulates a fairly large municipal style hall.	
5	Wood Hall	Simulates a medium-size hall with predominantly wooden interior.	
6	Cathedral	Simulates a large cathedral.	
7	Medconcert	Simulates a medium-size concert hall.	
8	Strings Hall	Simulates a concert hall designed for classical music.	
9	Castle Hall	Simulates a medieval castle.	
10	Small Hall	Simulates a small hall with warm sound character.	
11	Gymnasium	Simulates a gymnasium.	

2. ROOM		These effects simulate the reverb in various types of interior spaces, ranging from small rooms to large clubs.	
CHARACTER		REVERB TIME	Recommended setting
1	Tile Chamber	Simulates the acoustics of a tiled room.	
2	Warm Room	Simulates the acoustics of a room with warm sound character.	
3	Big Wooden	Simulates the acoustics of a fairly large room made of wood.	
4	Meeting Room	Simulates the acoustics of a conference room.	
5	Large Club	Simulates the acoustics of a large club with strong reverb.	
6	GtrSpace	Reverb with a pronounced midrange.	
7	Strings Room	Reverb emphasizing the low range and midrange.	
8	Small Chamber	Reverb which makes the spoken voice stand out clearly.	
9	Glass Room	Reverb with lean low end.	
10	Rehearsal Space	Simulates a rehearsal room with strong reverb.	
11	Garage	Simulates the reverb character of a garage.	

3. PLATE		These effects simulate the so-called "plate reverb" sound (as produced by a pickup mounted to a large, free-hanging iron plate).	
CHARACTER		REVERB TIME	Recommended setting
1	Large Plate	Simulates the reverb produced by a large plate.	
2	Bright Plate	Bright plate reverb suitable for percussion.	

3	Dark Plate	Plate reverb with a feeling of depth.	Reverb Time Sets the reverb duration.	
4	Clear Plate	Transparent plate reverb suitable for vocals.		
5	Short Plate	Plate reverb with short reverb time.		
6	Slap Plate	Reverb with a long pre-delay.		
7	Lo-Pass Plate	Plate reverb acting on the low frequencies.		
8	Hi-Pass Plate	Plate reverb acting on the high frequencies.		
9	Rich Plate	Dense, rich-sounding plate reverb.		
10	Endless Plate	Smooth plate reverb with long duration.		
11	Tunnel	Simulates the reverb as heard in a tunnel.		











4. VOCAL		Reverb effects best suited for vocals and narration.		
CHARACTER		REVERB TIME	Recommended setting	
1	Female Rock	Reverb suitable for female rock singers.	Reverb Time Sets the reverb duration.	
2	Male Ballad	Reverb suitable for ballads sung by male vocalists.		
3	Chorus	Reverb suitable for chorus music.		
4	Female Folk	Natural sounding reverb great for female vocals.		
5	Hi Male Rock	Reverb suitable for fairly high-pitched male vocals.		
6	Narration	Reverb suitable for emphasizing narration.		
7	Chanting	Reverb suitable for chanting.		
8	Slapback	Emphasizes vocals without changing other characteristics.		
9	Enhancer	Reverb with emphasized high end.		
10	LushVerb	Wide simulated space suitable for vocals.		
11	EchoVerb	Reverb with long pre-delay.		

5. AMBIENCE		These effects lend a natural sounding ambience to the sound source which is suitable not only for single instruments but also for stereo music sources.		
CHARACTER		REVERB TIME	Recommended setting	
1	Rock Mix	Reverb for rock type music sources.	Reverb Time Sets the reverb duration.	
2	Jazz Band	Reverb for jazz band type music sources.		
3	Reggae Mix	Reverb with a strong wet feeling, for reggae and related genres.		
4	Keyboard	Great ambience for keyboard playing.		
5	Hip Hop	Ambience for rap and hip hop type music.		
6	Film Score	Ambience for film music.		
7	Electronic Mix	Spatial effect suitable for synthesizer.		
8	New Age	Ambience suitable for MIDI sound sources.		
9	Strings Quartet	Warm, midrange centered ambience for strings.		
10	Choral Mix	Rich ambience for chorus and vocal ensembles.		
11	Percussion Mix	Ambience suitable for percussion ensembles.		

6. DIMENSION

These effects control the spatial expansiveness of the sound.













CHARACTER		REVERB TIME <small>Recommended setting</small>
1	Super Wide Emphasizes the stereo spread of music sources.	Reverb Time Sets the reverb duration.           
2	Stereo → Mono Changes the sound localization from stereo to mono.	
3	Left → Right Changes the sound localization from left to right.	
4	Right → Left Changes the sound localization from right to left.	
5	Big Delay Effect with long pre-delay for creating a wide space.	
6	Mono → Stereo Changes the sound localization from mono to stereo.	
7	StereoMids Adds a wide, expansive feeling to the midrange.	
8	Huge Bass Creates an expansive low end.	
9	Ping-Pong Reverb bouncing back and forth between left and right.	
10	Bass/Treble Adds reverb to the low and high range.	
11	Millennium Creates a vast reverb space.	

7. PERCUSSION

These reverb effects are most suitable for drums and percussion.









CHARACTER		REVERB TIME <small>Recommended setting</small>
1	Rock Kit/1 Reverb suitable for rock drum.	Reverb Time Sets the reverb duration.           
2	LatinPerc Light ambience for percussion.	
3	Jazz Drums Reverb for jazz drums.	
4	Tom Slightly deep effect for tom-toms.	
5	Shaker Creates optimum ambience for shakers and similar percussion instruments.	
6	Reggae Drums Midrange-centered effect for reggae drums.	
7	Rock Kit/2 Allows adding reverb to snares or cymbals without affecting the low range.	
8	MalletPerc Mallet type percussion can be enhanced with this effect.	
9	Slap Reverb with short pre-delay, emphasizing the low frequencies.	
10	Afro Drums Reverb suitable for Afro type drums.	
11	Bells High range effect suitable for bells.	

8. ENSEMBLE

These effects are best for ensemble sections such as strings or brass.



CHARACTER		REVERB TIME <small>Recommended setting</small>
1	Strings Reverb suitable for strings.	Reverb Time Sets the reverb duration.       
2	Brass Reverb suitable for brass ensembles.	
3	Piano Warm, extended reverb great for piano solos.	
4	Winds Reverb suitable for woodwinds.	
5	Synth/1 Reverb suitable for synthesizer.	
6	Solo Strings Reverb suitable for solo strings.	
7	Jazz Organ Light reverb for highlighting organ sound.	

8	Chorus	Wide reverb for chorus groups.	Reverb Time Sets the reverb duration.	
9	Solo Winds	Subdued reverb great for wind instrument solos.		
10	Church Organ	Reverb for adding a spacious feeling to organ music.		
11	Synth/2	Great reverb sound for synthesizer.		

9. POWER		These effects add a feeling of power and energy to sound sources.	
CHARACTER		REVERB TIME <small>Recommended setting</small>	
1	Kick/1	Stresses the body impact of bass drums.	
2	Kick/2	Increases the perceived size of the bass drum image.	
3	Snare/1	Stresses the body sound of snare drums.	
4	Snare/2	Adds a bright reverb sound to snare drums.	
5	Toms/1	Suitable for low toms and floor-standing toms.	
6	Toms/2	Emphasizes the midrange sound of tom-toms.	
7	Hand Perc	Suitable for hand percussion.	
8	DistGtr/1	Suitable for distortion guitar sound with strong box character.	
9	DistGtr/2	Suitable for distortion guitar sound with bright character.	
10	Vocal/1	Increases the power impact of vocals.	
11	Vocal/2	Suitable for ballad type vocals.	

10. GATE		Special effect where the reverb is briskly cut by a gate.	
CHARACTER		REVERB TIME	
Threshold	Adjusts the threshold level where the gate becomes active.	Reverb Time	Sets the reverb duration.

11. REVERSE		This achieves a similar effect as a tape run in reverse.	
CHARACTER		REVERB TIME	
Threshold	Adjusts the sensitivity of the effect, that is the level from which the reverb is applied.	Reverb Time	Sets the reverb duration.

• EFFECTS Bank

This bank contains seven sophisticated single effects (1 - 7) as well as four combined effects (8 - 11) which use two effects simultaneously. The combined effects marked with a "+" are made up of two effects connected in series. The combined effects marked with a "/" use two effects in parallel in the left and right channel.

1. COMP. LIM (Compressor • Limiter)		This effect serves for keeping signal levels within a certain range. The compressor raises the level of signals below a certain threshold and reduces the level of strong signals. The limiter only reduces the level of strong signals.	
VARIATION		REVERB TIME/ADJUST	
Comp Lim Release	Switches between compressor and limiter and adjusts the release time.	Threshold	Sets the level where the compressor/limiter becomes active.
1 - 6: Compressor Higher values mean longer release time.		7 - 11: Limiter Higher values mean longer release time.	

2. DELAY

A delay effect with a maximum delay time of up to 1486 ms.



VARIATION

REVERB TIME/ADJUST

Feedback Adjusts the amount of feedback (number of delay sound repetitions).

Delay Time Sets the delay duration.

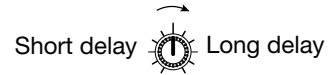
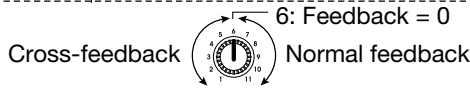

3. PITCH

Stereo pitch shifter which adds a pitch-shifted component to the original sound.



VARIATION

REVERB TIME/ADJUST

Pitch Shift Interval Sets the amount of pitch shift. The range extends from slight detune to 1 octave up or down.

Pitch Shift Up/Down Determines the direction of pitch shift.

VARIATION value	1	2	3	4	5	6	7	8	9	10	11
Shift (cent)	7	20	100	200	300	400	500	700	900	1100	1200

100 cent = 1 semitone



4. CHORUS

A stereo chorus with three voices per channel.



VARIATION

REVERB TIME/ADJUST

Chorus Depth Adjusts the depth of pitch modulation. Turning the control clockwise increases modulation.

Chorus Rate Adjusts the pitch modulation rate.



[Setting example] High-grade chorus with smooth presence VARIATION = 4 ADJUST

5. FLANGER

Stereo flanger with a wide range.



VARIATION

REVERB TIME/ADJUST

Flanger Depth Specifies the range over which the effect is active. Turning the control clockwise makes the range broader.

Flanger Rate Adjusts the flanger modulation rate.



[Setting example] Ultra-slow flanger great for hi-hat VARIATION = 10 ADJUST

6. PHASER

Phaser with pronounced fluctuation.



VARIATION

REVERB TIME/ADJUST

Phaser Depth Adjusts the intensity of the fluctuation. Turning the control clockwise results in more intense fluctuation.

Phaser Rate Adjusts the phaser fluctuation rate.



[Setting example] Fluctuation optimized for electric piano VARIATION = 7 ADJUST

7. TRM-PAN

Effect ranging from tremolo to auto-panning.







VARIATION

REVERB TIME/ADJUST

Depth Turning the control counterclockwise gives tremolo. Turning it clockwise gives auto-panning with a wider spread.

Rate Adjusts the tremolo to auto-panning rate.



8. DLY+REV		This is an in-series combination of delay and reverb.		↓↑ S/R
VARIATION		REVERB TIME/ADJUST		
Reverb Mix	Adjusts the mixing ratio of the reverb sound. Turning the control clockwise increases the reverb ratio.	Delay Time	Adjusts the delay time up to a maximum of 743 ms. (Feedback is fixed.)	
9. CHO+REV		This is an in-series combination of chorus and reverb.		↓↑ S/R
VARIATION		REVERB TIME/ADJUST		
Reverb Mix	Adjusts the mixing ratio of the reverb sound. Turning the control clockwise increases the reverb ratio.	Chorus Depth	Adjusts the modulation depth. (Modulation rate is fixed.)	
10. DLY/REV		This is a parallel combination of delay and reverb. The left channel carries the delay effect and the right channel the reverb effect.		↓↑ S/R
VARIATION		REVERB TIME/ADJUST		
Reverb Mix	Adjusts the mixing ratio of the reverb sound. Turning the control clockwise increases the reverb ratio.	Delay Time	Adjusts the delay time up to a maximum of 743 ms. (Feedback is fixed.)	
Weak reverb  Strong reverb		Short delay  Long delay		
11. FLG/REV		This is a parallel combination of flanger and reverb. The left channel carries the flanger effect and the right channel the reverb effect.		↓↑ S/R
VARIATION		REVERB TIME/ADJUST		
Reverb Mix	Adjusts the mixing ratio of the reverb sound. Turning the control clockwise increases the reverb ratio.	Flanger Rate	Adjusts the modulation rate. (Modulation depth is fixed.)	
Weak reverb  Strong reverb		Slow modulation  Fast modulation		



• MIX&SFX Bank

This bank comprises special effects such as MIC SIMULATOR and VOCODER as well as mixdown effects useful for mixdown (mixing multiple tracks onto two final stereo tracks).

The effects from this bank are best used with the MIX control turned fully clockwise, so that only the WET sound is output.





For effects 1 - 4, the parameters adjusted by the VARIATION control and REVERB TIME/ADJUST control are the same.

1. POWER MIX	Mixdown effect which emphasizes the bass and gives the sound a powerful punch.		
2. WIDE MIX	Mixdown effect which stresses the left/right stereo spread.		
3. BOOST MIX	Mixdown effect which gives the sound a tight low end and snappy high end.		
4. VOCAL MIX	Brings out suppleness and warmth in vocals by stressing the midrange and adding plate type reverb.		
VARIATION		REVERB TIME/ADJUST	
Reverb Color	Switches the reverb sound character.		Intensity
2 - 6: Short reverb mix ratio increases towards higher numbers.  7 - 11: Long reverb mix ratio increases towards higher numbers.		Adjusts the intensity of the respective effects.	
1: Reverb = Off 		Weak effect  Strong effect	



5. MIC SIMULATOR

Simulates the characteristics of a high-quality condenser microphone while using an economical dynamic microphone.

VARIATION		REVERB TIME/ADJUST	
Vocal/Inst Comp	Switches the characteristics for vocals or instruments, and adjusts the limiter sensitivity.	Enhance	Adjusts the intensity of the treble enhancer.
<p>1 - 6: Vocals Higher numbers result in higher limiter sensitivity.</p>  <p>7 - 11: Instruments Higher numbers result in higher limiter sensitivity.</p> 			



6. CABINET SIM

Adds the sound character of an amplifier speaker cabinet to the sound of an electric guitar.

VARIATION		REVERB TIME/ADJUST	
Combo/Stack & Depth	Selects the amplifier type (combo or stack) and adjusts the effect intensity.	Presence	Adjusts the level of the ultra high range.
<p>1 - 6: Combo type Higher numbers result in stronger cabinet sound.</p>  <p>7 - 11: Stack type Higher numbers result in stronger cabinet sound.</p> 			

7. ROTARY

Simulates a rotary speaker where the speaker is turned by mechanical means.

VARIATION		REVERB TIME/ADJUST	
Drive	Adjusts the amount of distortion. Turning the control clockwise increases distortion.	Rotary Rate	Adjusts the speaker rotation speed.
<p>Weak distortion  Strong distortion</p>		<p>Slow rotation  Fast rotation</p>	

8. RING MOD

This is a ring modulator with short delay.

VARIATION		REVERB TIME/ADJUST	
Delay Mode	Switches the delay mode.	Frequency	Sets the frequency with which the input signal is to be multiplied.
<p>1: Delay = Off Varies the input signal modulation frequency.</p>  <p>2 - 10: Varies the delay time from flanging to repeat delay.</p> <p>11: Feedback = Off</p>			

9. RESONANCE

This is a filter effect with a resonance component.

VARIATION		REVERB TIME/ADJUST	
Type & Q	Selects the filter type and adjusts the resonance intensity.	Frequency / Sensitivity	When the Type & Q parameter is set to manual (1 - 6), this control adjusts the cutoff frequency. When the Type & Q parameter is set to automatic (7 - 11), this control adjusts the sensitivity.
<p>1 - 6: Manually adjusts the cutoff frequency. Turning the control clockwise increases the resonance.</p>  <p>7 - 11: Uses the input signal envelope to automatically alter the cutoff frequency. Turning the control clockwise increases the resonance.</p>			

10. Lo-Fi EFX



This is a special effect that can be used to purposely degrade sound quality.

VARIATION		REVERB TIME/ADJUST	
Lo-Fi Color	Selects the sound character.	Tone	Adjusts the effect tone.

11. VOCODER

This effect lets you use a mic connected to the MIC IN jack to control the signal from a synthesizer supplied to the INPUT L jack. The signal supplied to the INPUT R jack is mixed with the MIC IN signal and can also be used as control signal.

To use this effect, turn the MIX control fully to WET.

VARIATION				REVERB TIME/ADJUST	
Mode & Character		Selects the number of filter bands for the VOCODER and the sound character.		Sensitivity	Adjusts the VOCODER sensitivity.
	1	18 bands	Fast attack	VOCODER only	
	2			+ chorus	
	3		+ distortion + chorus		
	4		Slow attack	VOCODER only	
5	+ distortion				
6	10 bands	Fast attack	VOCODER only		
7			+ chorus		
8		+ distortion + chorus			
9		Slow attack	VOCODER only		
10			+ chorus		
11	+ distortion + chorus				
				Low sensitivity  High sensitivity	

Troubleshooting

Symptom	Check	Remedy
No sound or very low volume	• Is sound source connected correctly to INPUT jacks and are OUTPUT jacks connected correctly to playback system?	Follow the instructions in "Getting Connected".
	• Are all shielded cables used for the connection okay?	Try replacing the shielded cables.
	• Are the connected sound source and playback system operating normally? Is the volume set to a proper position?	Check all components and set the volume to a suitable position.
	• Are INPUT control and OUTPUT control of RFX-1100 set properly?	Follow the instructions in "Trying Out the Effects" and adjust the controls properly.
	• Is a microphone connected to the rear-panel INPUT jack?	Connect the microphone to the front-panel MIC IN jack.
	• Are effects turned off and is the MIX control fully turned to the WET position?	Turn the MIX control towards DRY.
	• Is MIC ON/OFF switch set to OFF?	To use a microphone connected to the MIC IN connector, the MIC ON/OFF switch must be set to ON.
Input sound breaks up or is distorted	• Is input signal level too high?	Adjust INPUT control so that CLIP LED does not light at signal peaks.
	• Is a line-level device such as a synthesizer connected to the front-panel MIC IN connector?	The sensitivity of the MIC IN connector is optimized for microphones. Connect line-level devices to the rear-panel INPUT jacks.
No effect sound	• Were effects turned off with foot switch FS01 connected to rear panel?	Press foot switch again to turn effects on.
	• Is incorrect foot switch connected?	Use only ZOOM FS01.

Specifications

Preset programs	363 (11 effects x 3 banks x 11 variations)		(Unbalanced operation) Input impedance 50 kilohms
Sampling frequency	44.1 kHz		Reference input level -56 dBm
A/D converter	18 bit, 64 times oversampling	Outputs	2 x standard mono phone jack
D/A converter	18 bit, 8 times oversampling		Output impedance 500 ohms
Inputs	Line input 2 x standard mono phone jack Input impedance 10 kilohms (mono), 20 kilohms (stereo)	Control input	Reference output level -10 to +4 dBm
			FS01
Microphone input	Reference input level -10 to +4 dBm XLR-3-31/standard phone combo jack (Balanced operation) Input impedance 4.5 kilohm, pin 2 hot	Dimensions Weight Supplied accessory	482 (W) x 115 (D) x 44 (H) mm
			1.8 kg
			Power cord
		* 0 dBm = 0.775 Vrms	
		* Design and specifications are subject to change without notice.	

Safety Precautions/Usage Precautions

Safety Precautions

In this manual, symbols are used to highlight warnings and cautions for you to read so that accidents can be prevented. The meanings of these symbols are as follows:



Warning

This symbol indicates explanations about extremely dangerous matters. If users ignore this symbol and handle the device the wrong way, serious injury or death could result.



Caution

This symbol indicates explanations about dangerous matters. If users ignore this symbol and handle the device the wrong way, bodily injury and damage to the equipment could result.

Please observe the following safety tips and precautions to ensure hazard-free use of the RFX-1100.

Power requirements



Warning

- Connect only to AC power outlets rated 100-120 V or 220-240 V 50/60Hz (depending on the voltage range of the unit; refer to the back panel).
- Ground the unit by connecting the ground terminal of the power plug to a good external ground. Do not ground to water pipe, gas pipe, telephone wiring, or lightning arrester to prevent the risk of electric shock or explosion.
- During lightning or when not using the unit for an extended time, disconnect the power cord from the AC outlet.
- Do not pinch the power cord, bend it forcibly, or place heavy objects on the power cord.

Environment



Warning

Avoid using your RFX-1100 in environments where it will be exposed to:

- Extreme temperatures
- Heat sources such as radiators or stoves.
- High humidity or moisture
- Excessive dust or sand
- Excessive vibration or shock



Warning

Keep space around the unit for sufficient ventilation.

Do not impede the ventilation openings with objects such as newspapers or curtains.

Handling



Warning

- Never place objects filled with liquids, such as vases, on the RFX-1100 since this can cause electric shock.
- Do not place naked flame sources, such as lighted candles, on the RFX-1100 since this can cause fire.



Caution

The RFX-1100 is a precision instrument. Do not exert undue pressure on the keys and other controls. Also take care not to drop the unit, and do not subject it to shock or excessive pressure.

Alterations



Warning

Never open the case of the RFX-1100 or attempt to modify the product in any way since this can result in damage to the unit.

Volume



Warning

Do not use the RFX-1100 at a loud volume for a long time since this can cause hearing impairment.

Connecting cables and input and output jacks



Caution

You should always turn off the power to the RFX-1100 and all other equipment before connecting or disconnecting any cables. Also make sure to disconnect all connection cables and the power cord before moving the RFX-1100.

Usage Precautions

Electrical interference For safety considerations, the RFX-1100 has been designed to provide maximum protection against the emission of electromagnetic radiation from inside the device, and protection from external interference. However, equipment that is very susceptible to interference or that emits powerful electromagnetic waves should not be placed near the RFX-1100, as the possibility of interference cannot be ruled out entirely.

With any type of digital control device, the RFX-1100 included, electromagnetic interference can cause malfunctioning and can corrupt or destroy data. Care should be taken to minimize the risk of damage.

Cleaning

Use a soft, dry cloth to clean the RFX-1100. If necessary, slightly moisten the cloth. Do not use abrasive cleanser, wax, or solvents (such as paint thinner or cleaning alcohol), since these may dull the finish or damage the surface.

Please keep this manual in a convenient place for future reference.

The FCC regulation warning (for U.S.A.)

This equipment has been tested and found to comply with the limits for a Class B digital device, pursuant to Part 15 of the FCC Rules. These limits are designed to provide reasonable protection against harmful interference in a residential installation. This equipment generates, uses, and can radiate radio frequency energy and, if not installed and used in accordance with the instructions, may cause harmful interference to radio communications. However, there is no guarantee that interference will not occur in a particular installation. If this equipment does cause harmful interference to radio or television reception, which can be determined by turning the equipment off and on, the user is encouraged to try to correct the interference by one or more of the following measures:

- Reorient or relocate the receiving antenna.
- Increase the separation between the equipment and receiver.
- Connect the equipment into an outlet on a circuit different from that to which the receiver is connected.
- Consult the dealer or an experienced radio/TV technician for help.

ZOOM®
CATCH US IF YOU CAN

ZOOM CORPORATION

ITOHPA Iwamotocho 2chome Bldg., 2-11-2, Iwamoto-cho,
Chiyoda-ku, Tokyo 101-0032, Japan
Web Site: <http://www.zoom.co.jp>