

R24

Recorder:Interface:Controller:Sampler

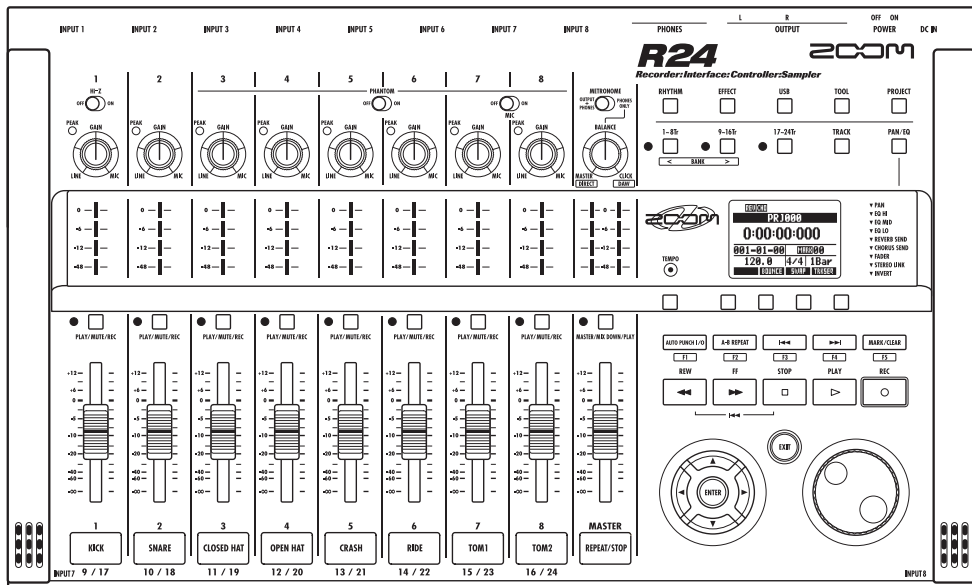

OPERATION MANUAL



Operation manual can be downloaded from the ZOOM official website.
(www.zoom.jp/docs/r24)

ZOOM

© ZOOM Corporation

Reproduction of this manual, in whole or in part, by any means, is prohibited.

Usage and safety precautions

SAFETY PRECAUTIONS

In this manual, symbols are used to highlight warnings and cautions that you must read to prevent accidents. The meanings of these symbols are as follows:



Warning

This symbol indicates explanations about extremely dangerous matters. If users ignore this warning and handle the device incorrectly, serious injury or death could result.



Caution

This symbol indicates explanations about dangerous matters. If users ignore this caution and handle the equipment incorrectly, bodily injury and damage to the equipment could result.

Please observe the following precautions to ensure safe use of this unit.

Power requirements



Warning

Since the power consumption of this unit is high, we recommend using the AC adapter. When using batteries, use either alkaline or nickel-metal hydride batteries.

Operation using an AC adapter

- Be sure to use only a DC5V/1A/center plus AC adapter (ZOOM AD-14). Use of an AC adapter other than that specified could damage the unit, cause malfunction or result in a fire or other trouble.
- Connect the AC adapter only to an outlet that supplies the rated AC voltage required by the adapter. Before using the R24 in other countries (or regions) where the power voltage differs from AC 100 V, always consult with a store that handles ZOOM products and use a suitable AC adapter.
- When disconnecting the AC adapter from an outlet, always pull the body of the adapter itself.
- During lightning storms or when not using the unit for an extended period of time, disconnect the AC adapter from the AC outlet.

Operation using batteries

- Use six conventional 1.5-volt AA batteries
- The R24 cannot recharge batteries.
- Read battery labels carefully.
- When not using the unit for an extended period of time, remove the batteries from the unit.
- If a battery leak should occur, wipe the battery compartment and the battery terminals carefully to remove all battery residue.
- Always close the battery compartment cover when using the unit.

About grounding

Depending on the placement conditions of the unit, a slight electrical charge might be felt when touching a metal part of the R24. If you wish to avoid this, ground the unit by connecting an external ground to a screw on the rear panel. To avoid danger from electricity, never connect it to any of the following for grounding.

- Water pipes (risk of electric shock)
- Gas pipes (risk of explosion)
- Telephone wiring grounds or lightning arrestors (danger during lightning strikes)

Operating environment

Avoid using the R24 where it might be exposed to the following conditions that could cause it to malfunction.

- Extremely high or low temperatures
- Very high humidity or splashing water
- Excessive dust or sand
- Excessive vibrations



Caution

Handling



Warning

Never put vases or other items filled with liquids on the R24 as they could cause electric shock.



Caution

The R24 is a precision instrument. Do not put unnecessary pressure on the keys and other controls. Use of excessive force and dropping or bumping the unit, for example, could cause the unit to break.

Connecting cables with input and output jacks



Caution

Always turn the power OFF for all equipment before connecting any cables. In addition, make sure to disconnect all connection cables and the AC adapter before moving the unit.

Alterations



Caution

Never open the case or attempt to modify the product in any way since this could result in damage to the unit. Zoom Corporation will not take any responsibility for damage resulting from alterations to the unit.

Volume



Caution

Do not use the R24 at a loud volume for a long time. Doing so could damage hearing.

Usage Precautions

Interference with other electrical equipment

In consideration of safety, the R24 has been designed to provide maximum protection against the emission of electromagnetic radiation from the device and to be protected from external interference. However, equipment that is very susceptible to interference or that emits powerful electromagnetic waves could result in interference if placed near the R24. If this occurs, place the R24 and the other device farther apart. With any type of electronic device that uses digital control, including the R24, electromagnetic interference could cause malfunction, corrupt or destroy data and result in other unexpected trouble. Always use caution around other devices.

Cleaning



Use a soft cloth to clean the panels of the unit if they become dirty. If necessary, use a damp cloth that has been wrung out well. Never use an abrasive cleanser, wax or solvent including alcohol, benzene and paint thinner.

Malfunction

If the unit becomes broken or malfunctions, immediately disconnect the AC adapter, turn the power OFF and disconnect other cables. Contact the store where you bought the unit or Zoom service with the following information: product model, serial number and specific symptoms of failure or malfunction, along with your name, address and telephone number.

Copyrights

Except for personal use, unauthorized recording of copyrighted sources, including CDs, records, tapes, video products, broadcasts, is prohibited. Zoom Corporation does not bear any responsibility for any consequences related to copyright law infringement.

©  The SD symbol and  SDHC symbol are trademarks. © Windows®/Windows Vista® are trademarks or registered trademarks of Microsoft®. © Macintosh® and Mac OS® are trademarks or registered trademarks of Apple Inc. © Steinberg and Cubase are trademarks or registered trademarks of Steinberg Media Technologies GmbH Inc. © Intel® and Pentium® are trademarks or registered trademarks of Intel® Corporation. © AMD Athlon™ is a trademark or registered trademark of Advanced Micro Devices, Inc.

© All other trademarks, product names, and company names mentioned in this documentation are the property of their respective owners.

© All trademarks and registered trademarks mentioned in this manual are for identification purposes only and are not intended to infringe on the copyrights of their respective owners.

Introduction

Please read through this manual carefully in order to understand the R24 functions well. After reading it, please keep the manual along with the warranty in a safe place.

Thank you very much for purchasing the ZOOM R24 Recorder:Interface:Controller:Sampler. We will call it simply the “R24” in this manual. The R24 has the following features.

■ Multitrack recorder that can use up to 32 GB SDHC cards

The R24 can record up to 8 tracks simultaneously, allowing serious live recording. For example, you can record a complete band on individual tracks or a drum kit with multiple microphones. After making linear PCM recordings (WAV format) at 16/24-bit and 44.1/48-kHz sampling rate, you can transfer recorded files to your computer to use them in DAW software. You can even connect two R24s together with a USB cable, allowing recording of up to 16 tracks.

■ Hi-Speed USB (USB 2.0) audio interface

You can use the R24 and its many input and output jacks as a Hi-speed USB (USB 2.0) audio interface. As an interface, the R24 can handle 8 inputs and 2 outputs at a maximum of 24-bit and 96 kHz. Its effects can even be used (at 44.1 kHz only). The unit can also operate using USB bus power.

■ Usable as a control surface for DAW software

The R24 has functions that enable control of DAW software on a computer via a USB cable. You can operate its transport, including play, record and stop keys and physically control onscreen faders. You can also assign various DAW functions to the R24's F1–F5 function keys. (The assignable functions depend on the DAW software.)

■ Diverse effects

The R24 has two types of built-in effects. Insert effects can be applied to specific channel signals and send-return effects can be used through the mixer send-return bus. You can use these effects in a wide variety of ways, including during recording, by applying them to already recorded tracks, and in the mastering process of mixing down and bouncing.

■ Comprehensive built-in mixer features

The R24 is equipped with a digital mixer that allows you to mix the playback of audio tracks. You can adjust the volume, pan, EQ and effects for each track and mix them into a stereo signal.

■ Handles a variety of input sources including guitars, microphones and line-level equipment

The R24 is equipped with 8 input jacks that accept both XLR and standard phone connectors, including 1 that can handle high impedance and 6 that can supply phantom power (24 V or 48 V). The R24 can handle all types of sources, including high impedance guitars and basses, dynamic and condenser microphones, and synthesizers and other line level instruments. It also has two built-in high-performance microphones that are convenient for recording acoustic guitars and vocals.

■ Exchange files with computers and USB memory devices

The R24 has a USB 2.0 jack that allows high speed data transfer. You can transfer WAV audio files recorded on the R24 to a computer just by dragging and dropping. You can also exchange files with a connected USB memory device without using a computer.

■ 24-voice built-in sampler can be triggered using 8 pads and 3 bank keys

Use the sampler to assign sounds to each track (pad) and create loops. Play the pads in real-time, and even create performance data for a complete song by combining loops. By simply lining up drum loops, anyone can easily create professional-quality backing parts and basic tracks. While listening to loop playback, you can record audio on other tracks because the R24 recorder and sampler work together seamlessly.

■ Rhythm and metronome functions can be used as guides and backing tracks

The unit starts with over 400 rhythm patterns that use the built-in drum machine, and you can create your own original patterns using both real-time and step input. You can output the metronome sound only to the headphones, allowing you to send just a click to the drummer in a live situation, while the signals from the output jacks are sent to a mixer.

Note: For the improvement of this product, its specifications are subject to change without notice.

Contents

Usage and safety precautions	1
Introduction	2
Contents	3
R24 operation flow	5
Basic recording guide	7
Panel layout and functions	9
Connections	11
SD card installation	12
Powering the unit	13
Turning the power on & off	14
Date & time setting	14
Switch and key operation overview	15
Display information	16
UNDO/REDO	

Recording preparations

R24 recording flow	17
Creating a new project	17
Connecting instruments	18
Making mono settings	18
Hi-Z	
Phantom power	
Stereo settings & status keys	19
Built-in mics	
Stereo line inputs	
Stereo link	20
Setting the tempo	21
Preparing a rhythm track	22

Track recording

Recording the first track	23
Adjusting gain, recording and playback	
Changing the playback take	25
Swapping tracks	

Overdubbing

Recording additional tracks	27
Playing already recorded tracks	
Recording and playback	

Re-recording

Automatic punch-in/punch-out	29
Manual punch-in/punch-out	30

Playback

Project playback	31
Repeat playback of a specific section (A-B repeat)	32
Using the counter and marks to locate	33
Mark functions	

Tools

Tuner	35
Metronome	36
16-track synchronized recording with two units	37

Mixing

R24 mixing process	39
EQ, pan and send level track settings	40
Track parameters	41

Mix down/Bounce

Combine multiple tracks into 1–2 tracks	43
Bouncing	
Using a mastering effect	45
Recording to the master track	46

Sampler functions

Using the sampler to make songs	47
Overview of sampler functions	48
Assigning tracks	49
Loop settings	50
Playing the pads	52
Playback methods	
Global quantization	
Creating a sequence	53
Real-time input	
Step input	

Editing a sequence	56
Inserting and deleting beats	
Changing the time signature	
Playing back a sequence	59
Changing the BPM	60
Changing tempo without changing pitch	61
Trimming unnecessary parts of audio files	63
Setting fade-ins and fade-outs	64

Rhythm function

Overview of rhythm functions	65
Playing rhythm patterns	66
Selecting a rhythm pattern	
Selecting the drum kit	
Playing pad sounds	67
Switching banks	
Drum rolls	
Pad sensitivity	
Creating a rhythm pattern	68
Setting bars, time signature, quantization	
Checking remaining memory	
Real-time and step input	
Copying rhythm patterns	71
Deleting rhythm patterns	72
Changing rhythm pattern names	73
Import rhythm patterns	74
Setting volume and stereo placement	75
Assigning rhythm patterns to tracks	76

Effects

Effect and patch overview	77
Input and output of insert and send-return effects	79
Effect patch selection	
Setting the insert effect position	81
Patch editing	83
Patch saving	85
Patch importing	86
Using the insert effect only for monitoring	87

Projects

Project overview	89
Project protection	89
Creating a new project	90
Selecting projects and files	91
Project and file information	92
Copying projects and files	93
Changing project and file names	94
Deleting projects and files	95
Dividing files	96
Sequential playback of projects	97
Recording settings	99

System/SD cards

Adjusting the display	100
Backlight and contrast	
Changing the SD card while the power is on	101
Formatting SD cards	102
Checking card capacities	102
Checking the system version	103
Setting the battery type	103
Phantom power settings	104

USB

Connecting with a computer	105
Card reader	106
Using USB memory to save and import data	107
Audio interface/control surface	110
Rhythm pattern list	113
Effect types and parameters	115
Effect patch list	126
Error message list	132
Specifications	133
Troubleshooting	134
Upgrading the firmware	135
Index	137

R24 operation flow

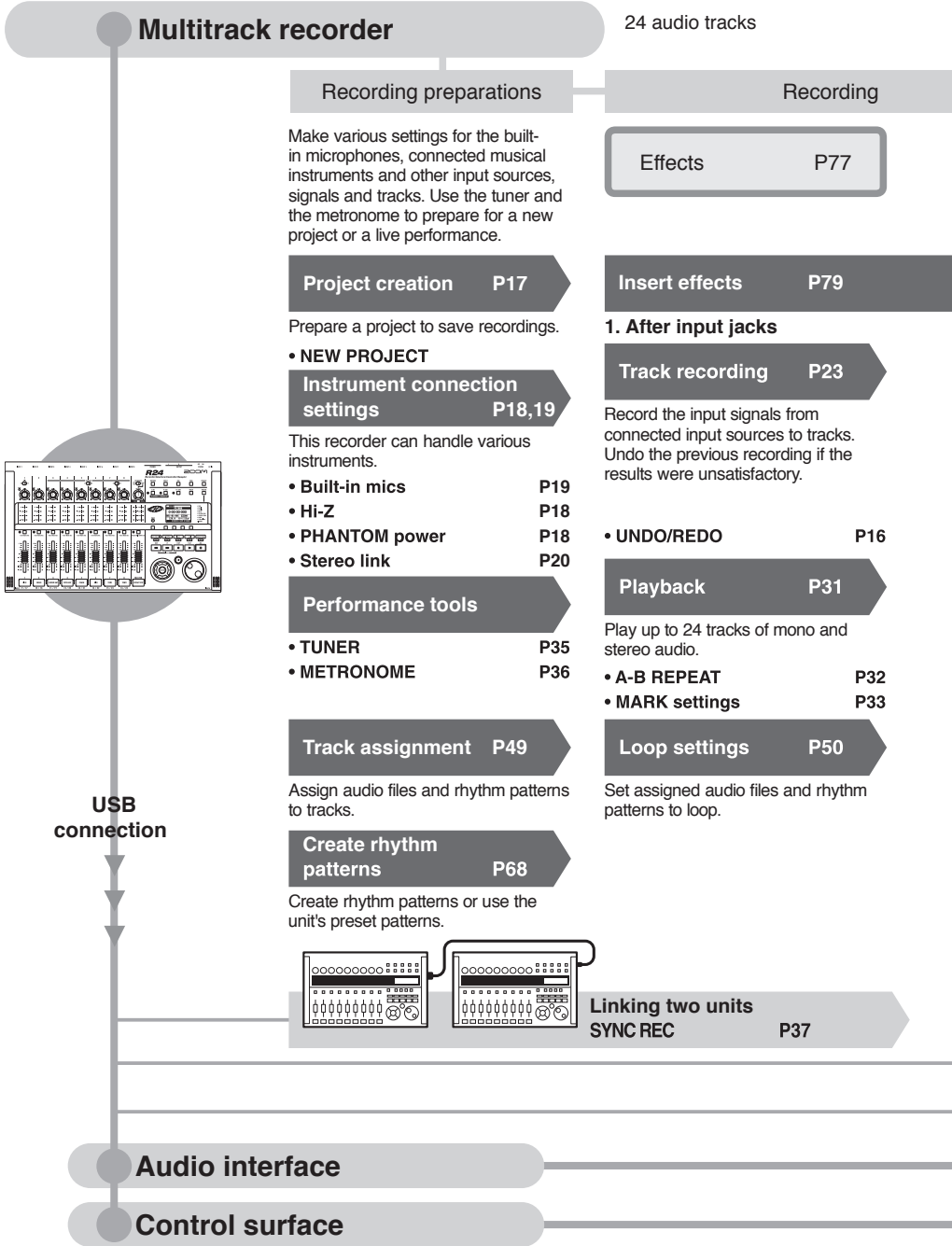

8 simultaneous tracks of stereo and mono recording

Track mixer
330 types of effects

Mixing mixdown

Editing & output

Apply various effects to process input signals, recorder playback and sound generator output.

Mixer P39

Project P89

• **PATCH EDIT, etc.** P83~

Adjust recorded tracks using the track mixer.

Recorded sound files and settings can be managed and stored on a per song basis as a project and then edited in various ways.

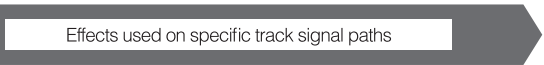

2. Desired tracks in mixer

3. Before the MASTER fader

Overdubbing P27

Send-return effect

Record new tracks while playing back previously recorded tracks.

There are two internal send/return effects in the built-in mixer—a chorus/delay effect and a reverb effect. Adjust the effect send levels for each mixer track individually.

Re-recording

Re-record just part of a recorded file.

- **PROJECT/FILE INFORMATION** P91
- **PROJECT/FILE INFORMATION** P92
- **DIVIDE** P96
- **COPY** P93
- **DELETE** P95
- **RENAME** P94
- **PROTECT** P89

• **PUNCH IN/OUT** P29

Mixing P39

Adjust parameters for each track.

SD card P101

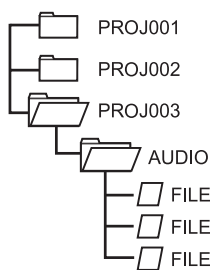

• **EQ • Volume • Pan** P40

Mixdown

Combine multiple tracks into one stereo track.

Create a sequence P53

Use looped material to create performance data for an entire song.

• **Bounce** P43
• **Recording a MASTER track** P46

Card reader P106

USB memory P107

Send signals between DAW software and audio equipment.

P110~

Audio interface manual

Operate DAW software with the R24.

P110~

Audio interface manual

Basic recording guide

Make a quick recording with the R24

Here we explain how to record in stereo with the built-in microphones on the unit's left and right sides and how to record an electric guitar in mono using the high impedance input.

STEP 1 Insert an SD card and turn the power on.

STEP 2 Create a new project.



PROJECT

1 Press

Change menu



Use the up/
down keys

2 Select NEW.

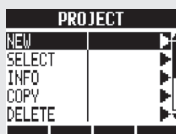

Press

3 Confirm the project name, etc.

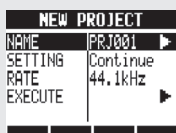

Change menu



Use the up/
down keys

4 Select EXECUTE.



Press

Return to the main screen.



Ref: Projects

P89

STEP 3 Turn the input source ON.

Using built-in mics (stereo recording)

1 Turn the **INPUT 7 & 8 MIC** switch **ON**.

2 Press the status keys of **INPUTS 7 & 8** until their indicators light red.



or

Recording an electric guitar
(high-impedance mono input)

1 Connect the guitar to **INPUT 1**.

2 Turn the **INPUT 1 Hi-Z** switch **ON**.

3 Press the status key of **INPUT 1** until the indicator lights red.



NOTE

- Hi-Z is only on **INPUT 1**, and the built-in stereo microphones function only on tracks 7 & 8.
- Tracks 7 & 8 correspond to **INPUT 7 & 8** and are set up as two mono tracks by default. To use the built-in mics for a stereo recording, set stereo link to create one stereo track.

Ref: Stereo link
Connecting instruments

P20
P18, 19

STEP 4 Adjust the input sensitivity, monitoring level and output

1 Adjust the input sensitivity (GAIN)

Adjust the **GAIN** of each **INPUT** so that their **PEAK** indicators blink occasionally.

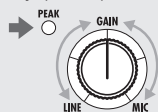

2 Adjust the recording level

The red (0 dB) indicator of the level meter should not light when you apply an insert effect to an **INPUT**. Adjust the patch level, for example, if necessary.

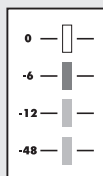

3 Adjust the monitoring level

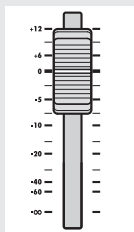

Adjust the monitoring level of an instrument with the fader of the track it is being recorded on. (**INPUT 1** would be track 1, 9 or 17, for example.)

NOTE

- If an input signal distorts during recording, refer to STEP 4 and adjust the input sensitivity and recording level.
- After recording has completed, the “Please wait” pop-up will be displayed. Do not turn the power OFF or take the SD card out while this pop-up is open. Doing so could damage data or cause other problems.

Ref: Recording methods in detail
Using insert effects

P17~

P81

STEP 5 Record—Complete—Play

Recording

- 1 While pressing press to move to the beginning.



- 2 Press and then to start recording.

- 3 Start performing.

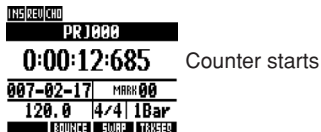

- 4 Press to stop recording.

Playback

- 1 Press the status key to end recording standby and make the light green.



The track changes from recording standby (red) to playback standby (green).

- 2 While pressing press to move to the beginning.

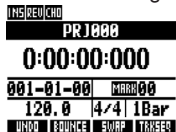

- 3 Press to start playback.



- 4 Press to stop playback.

Panel layout and functions

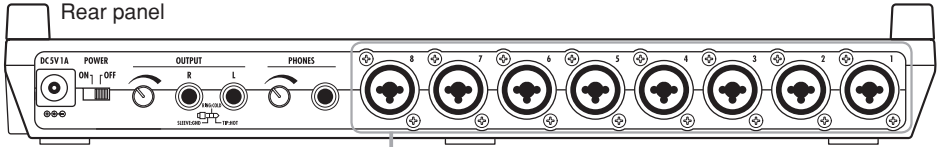

Rear panel

Input section

Control section

Level meters
(1/9/17-8/16/24, MASTER)

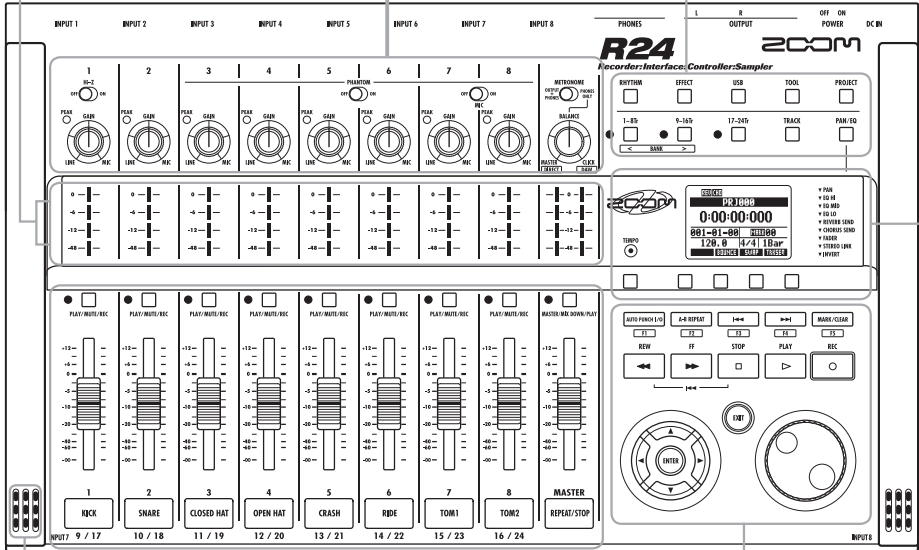

Built-in mic

Fader section

Transport section

Display section

Display

TEMPO indicator

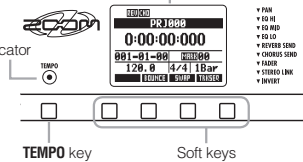

Right side panel

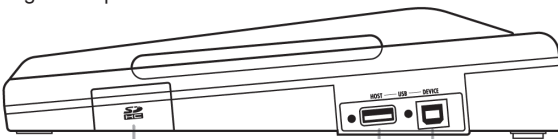

SD card slot

USB HOST port

USB DEVICE port

Bottom panel (not shown)
Battery compartment

Input section

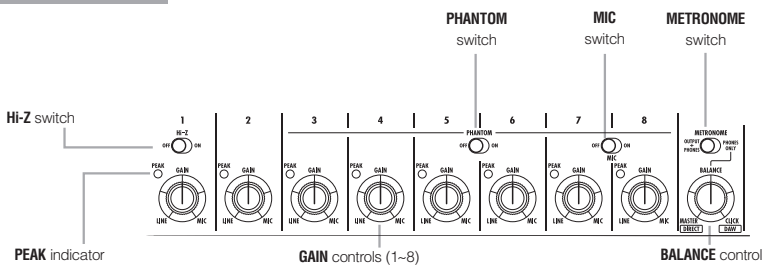

Fader section

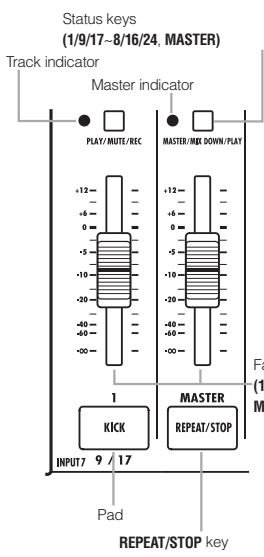

Control section

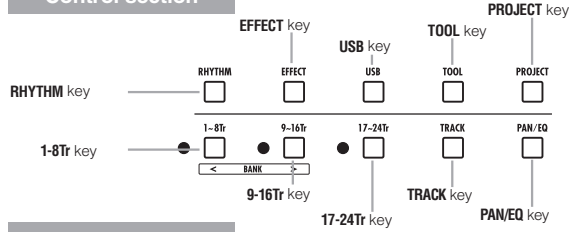

Transport section

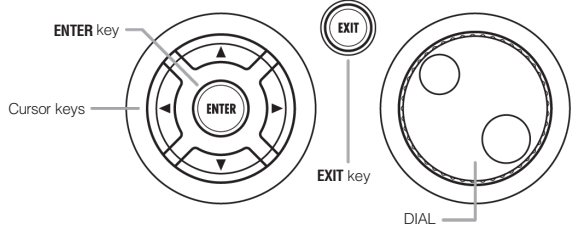
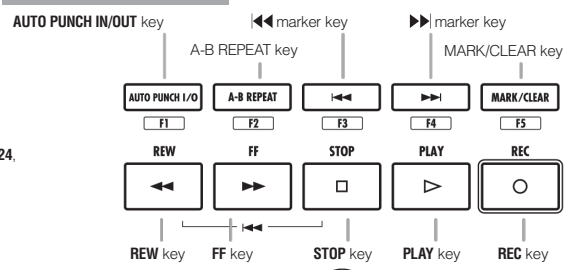

Rear panel

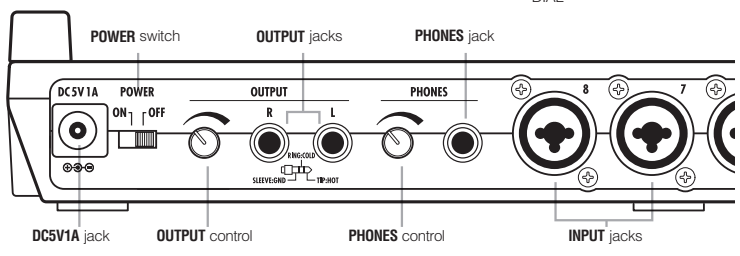

Connections

Refer to the following to connect other devices, including instruments, microphones, audio equipment and computers.

Outputs

Set the **METRONOME** switch to output it to only the **PHONES** jack or also to the **OUTPUT** jacks.

1 Stereo system, speakers with built-in amplifiers, etc.

Turn off the system's power (or turn down the volume) before connecting speakers to avoid damage.

Inputs

Connect cables with XLR or mono phone plugs (balanced or unbalanced) to the **INPUT** jacks.

2 Microphones

In order to supply phantom power to a condenser microphone, first connect the microphone to **INPUT 5** or **6** and then turn the **PHANTOM** switch **ON**. Phantom power can also be provided to **INPUTS 3,4,7** and **8** (see P104).

3 Devices with stereo outputs

When using a synthesizer or a CD player, for example, with stereo outputs be sure to connect its left output jack to an odd-numbered **INPUT** jack on this unit and its right output jack to an even-numbered **INPUT** jack.

4 Guitar/bass

When directly connecting a passive electric guitar or bass, use **INPUT 1**, which can handle high impedance, and turn the **Hi-Z** switch **ON**.

5 Built-in microphones

Use these microphones to record drums indirectly or record a band. Turn the **MIC** switch **ON** to input the sounds to **INPUTS 7** and **8**.

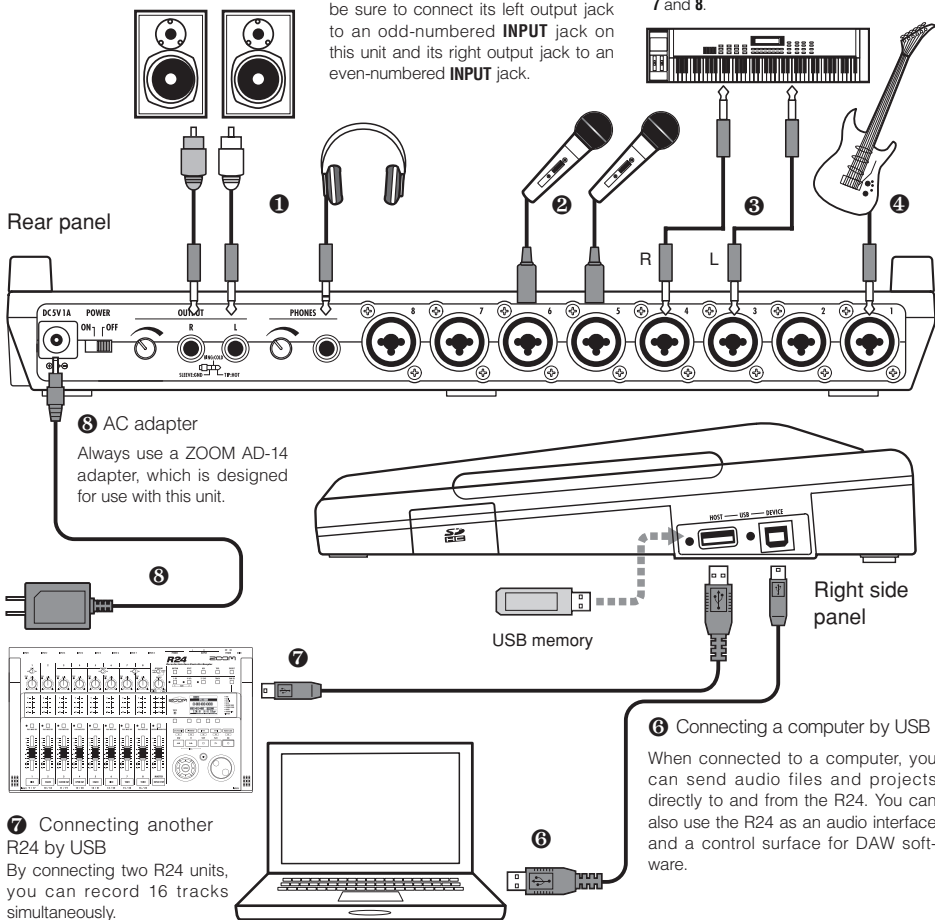

7 Connecting another R24 by USB

By connecting two R24 units, you can record 16 tracks simultaneously.

6 Connecting a computer by USB

When connected to a computer, you can send audio files and projects directly to and from the R24. You can also use the R24 as an audio interface and a control surface for DAW software.

SD card installation

The R24 saves recording data and settings on SD cards.

To protect your data, turn the power off before inserting or ejecting a card.

An SD card is necessary for recording.

Turn the power OFF beforehand (ordinary use)

1 Turn the POWER OFF and detach the cover of the SD card slot.

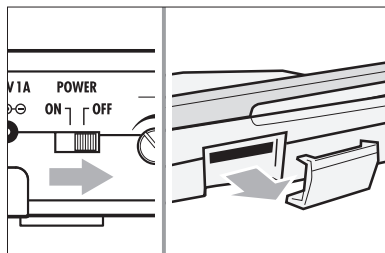

2 Insert an SD card that is not write-protected into the slot completely. To eject, push the card in first .



Unlock the write-protection

Preventing unwanted removal of an SD card

Remove the screw near the slot, and screw it into the hole in the SD card cover.

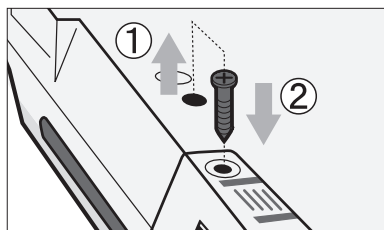

NOTE

- If you want to change the SD card while the power is ON, follow special procedures (see P101).
- When inserting or removing an SD card, always turn the power OFF. If you do so when the power is ON, recording data might be lost.
- If you cannot insert a card into the slot, you might be trying to insert it in the wrong direction or upside down. Try again with the correct card orientation. If you force the card in, you might break it.
- If an SD card was previously used with a computer or a digital camera, you must format it in the R24 before using it.
- If no SD card is inserted, the REC key will not function in Recorder Mode.

If one of these messages is shown

- "No Card": No SD card is detected. Make sure an SD card is inserted properly.
- "Card Protected": The SD card write-protection lock is closed, preventing rewriting. To release it, slide the switch away from the lock position.

HINT

- This unit can use SD cards with capacities of 16 MB~2 GB, as well as 4~32 GB SDHC cards.
- You can check the most recent information about compatible SD cards on the ZOOM website. <http://www.zoom.co.jp>

Ref: SD CARD>EXCHANGE
SD CARD>FORMAT

P101

P102

Powering the unit

Use the included AC Adapter, which is designed for the unit, or six AA batteries (sold separately) to power the unit.

Using ordinary power (included AC adapter)

- 1 **Make sure that the power is OFF, and then plug the included AC adapter into the back of the unit.**

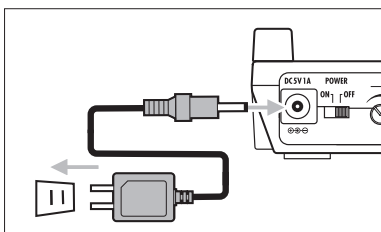

Caution Always use the included ZOOM AD-14 AC adapter, which is designed for use with the unit. Using any other adapter could damage the unit.

Using batteries

- 1 **Turn the power OFF and open the battery case cover on the bottom of the unit.**
- 2 **Install the batteries and close the cover.**

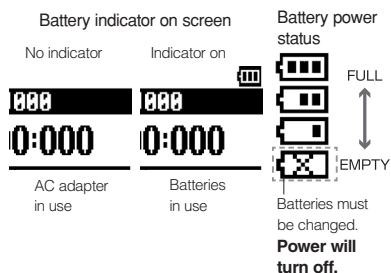
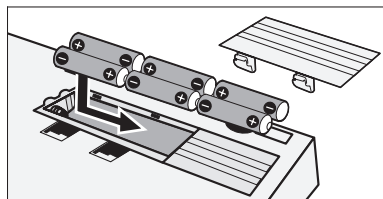

HINT

Power supply from USB

If the **POWER** switch is set to **OFF**, connecting the unit to a computer with a USB cable makes the unit start-up automatically with power supplied by USB. In this state, functions are different from when the **POWER** switch is **ON**. The unit can be used only as an SD card reader or as an audio interface.

- When using the unit as an audio interface, if supplying phantom power, we recommend that you use the AC adapter.

NOTE

- Always turn the power OFF when you open/close the battery cover or plug/unplug the AC adapter. Doing so when the power is ON might cause recording data to be lost.
- The unit can use alkaline or NiMH batteries. The approximate lifetime for alkaline batteries is about 4.5 hours.
- Replace the batteries when "Low Battery!" is shown. Turn the **POWER** switch to **OFF** immediately and install new batteries or connect the included AC adapter.
- Set the battery type to increase the accuracy of the battery indicator.

Ref: Setting the battery type

P103

Turning the power on & off/Date & time setting

Follow these precautions for starting-up and shutting down the unit.

Follow these instruction to set the date and time for files and data.

Turning the power on & off

1. Make sure all the equipment is OFF.
2. Insert an SD card into the R24. Confirm that the power, the instruments and the monitoring system (or stereo headphones) are correctly connected.

Turn the power ON to start the unit

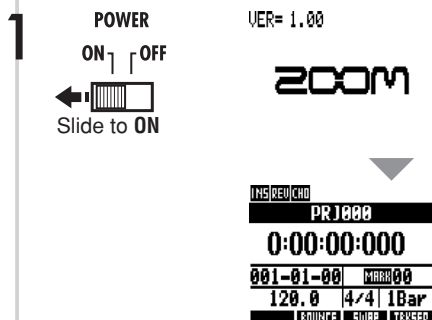

- 2 Then turn the power ON for connected instruments and for the monitoring system in that order.

Turn the power OFF to shut down the unit

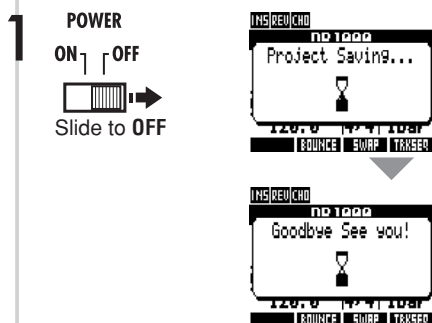

NOTE

- Before turning the **POWER ON**, turn down **PHONES** and **OUTPUT** controls and volume on monitoring systems and other connected devices.
- If no power is supplied to the unit for more than a minute, the **DATE/TIME** setting will be reset to its initial value.

Setting the date and time

TOOL>SYSTEM>DATE/TIME

- 1 Press
- 2 Select **SYSTEM**.
- 3 Select **DATE/TIME**.
- 4 Select the date and time units and set their values in the following order.
 YEAR > MONTH > DAY > 00:00:00
- 5 Select **OK**.

If this message appears

Reset DATE/TIME

- The **DATE/TIME** setting has been set to its initial value. Set the **DATE/TIME** again.

Switch and key operation overview



Here we explain how to use the keys and switches of the R24. Please look at the display for icons that show key functions.

Transport section





	REC key	Functions only when tracks are in recording standby.
When stopped	Starts recording standby	
Recording standby	Ends recording standby	
During playback	Starts recording (manual punch-in/punch-out)	

	PLAY key	
When stopped	Starts playback	
Recording standby	Starts recording	

	STOP key	
During recording	Ends recording	
During playback	Stops playback	
Recording standby	Stops unit	

	REW key	
Stopped/playback	Rewinds	
 	Hold STOP and press REW to return to the top of the song.	





	FF key	
Stopped/playback	Fast forwards	

	ENTER key	Confirm items.
	EXIT key	Press to go back. Hold to return to the top screen.
	DIAL	Change and move among menus and numbers.
	MARK/CLEAR	Ref.: Mark-related keys P33
	A-B REPEAT	Set/cancel auto punch-in/out and A-B repeat

Cursor appearance and indication in manual













Indications in manual Unit



Appearance in manual	
 	Move in menu
 	In the explanations, only the usable directions are shown

Note: The cursors are used often to move up, down, left and right to choose different items. An example of their notation in the manual is shown above.

Control section

	RHYTHM key	Play, create and set rhythm patterns
	EFFECT key	Set the insert and send-return effects
	USB key	Use audio interface, card reader and USB memory
	TOOL key	Metronome, tuner, system and SD card settings
	PROJECT key	Create, set and work with projects
	1-8Tr key	Switch between track groups 1~8, 9~16 and 17~24 (the indicator for the active track bank lights)
	9-16Tr key	
	17-24Tr key	
	TRACK key	Assign tracks and make settings
	PAN/EQ key	Access track mixer settings

Fader section

	1/9/17-8/16/24 TRACK status keys	Change track status to PLAY (green), MUTE (no light) or REC (red). Playback tracks that are already assigned appear orange.
	MASTER status key	Change MASTER track status to PLAY (green), MASTER (no light—no playback/recording) or MIX DOWN (red).

Switches and controls

POWER switch	Turns power ON & OFF
Hi-Z switch	Turns Hi-Z connection on/off (only for INPUT 1)
MIC switch	Turns built-in microphones on/off (signals to INPUTS 7 & 8)
METRONOME switch	Sets metronome output
PHANTOM switch	Turns phantom power ON & OFF

GAIN control	Adjusts input sensitivity
PEAK indicator	Lights if maximum input detected
BALANCE control	During recording, when the METRONOME switch is set to PHONES ONLY , use to balance the volume of the stereo mix and the metronome
Level meters	Shows recording/playback levels
TEMPO indicator	Flashes in time with the count

Display information

The display shows data about projects and other elements, connection and operation status as a recorder or a computer audio-interface, available functions and various menus.

Display and indications

Top Screen: Shows the current project

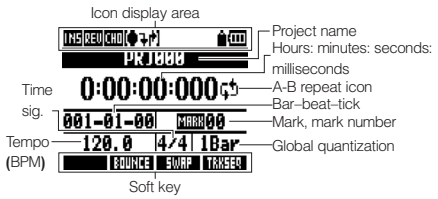

Menu screen: Shows an operation menu

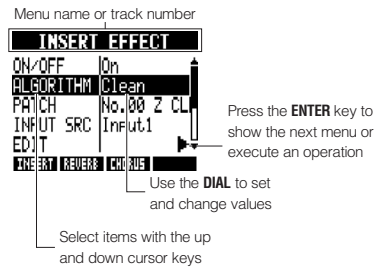

Icon display and setting keys

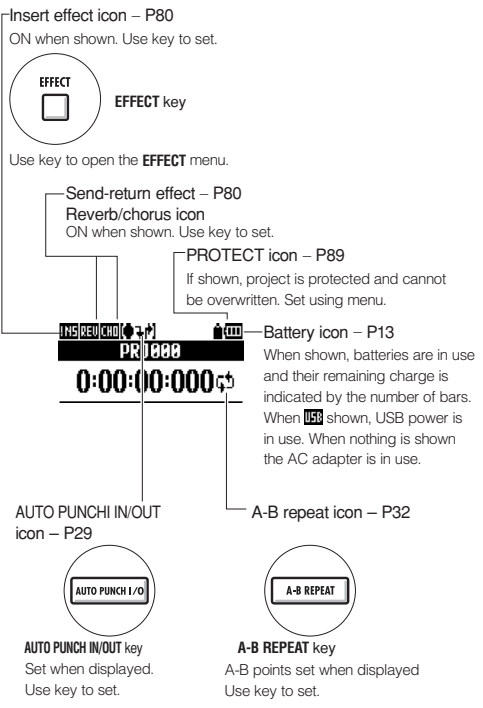

The indications in enclosed in boxes, including **F1–F5** beneath the row starting with the **AUTO PUNCH I/O** key, **<BANK >**, **DIRECT**, and **DAW**, are functions when used as a control surface in audio interface mode.

Soft keys



The functions of the soft keys appear at the bottom of the display. Press the key under the indication to use that function.

UNDO/REDO



UNDO indicator REDO indicator

UNDO: Return to the state before the previous operation after (PUNCH IN/OUT) recording, BOUNCE or MIX DOWN (to MASTER TRACK)
REDO: Reverse the UNDO operation

When indicators are shown
 After recording and certain other operations, "UNDO" is shown. After pressing the UNDO soft key, "REDO" is shown. Press the soft key to execute.

NOTE

- Undo only works on tracks with recorded audio data
- Only the previous operation can be undone. Any earlier operations cannot be undone.

R24 recording flow/Creating a new project

With the R24, you can use multitrack recording to create a complete work of music. Create a new project for each song that you make.

Recording preparations

Connecting instruments

Project and track settings

Create a new project

Select the **INPUTS** and the recording tracks

Set stereo links

Change track status (recording, play, mute)

Adjust input sensitivity using the **GAIN** controls

Performance preparation

Set metronome including pre-count

Set and use tuner

Recording the first tracks

Recording standby—record—stop

Recording more tracks

Overdubbing

Playback of already recorded tracks

Overdubbing

Record standby—Record—Stop

Create a new project

1 PROJECT
 Press

2 Select NEW.



3 Confirm the project NAME.



4 Select whether to CONTINUE using the previous settings.



5 Set the sampling RATE.

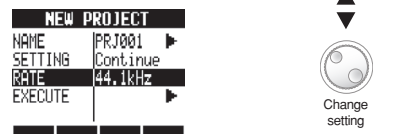

6 Select EXECUTE.



HINT

You can change the name of the new project in step 3.

Connecting instruments/Making mono settings

Make settings for instruments such as high impedance guitars, line-input synths, the built-in mics and mics that use phantom power as well as for stereo and mono input sources.

Connecting passive-type guitars

Connect the high impedance instrument to **INPUT 1**, and then turn the **Hi-Z** switch **ON**.

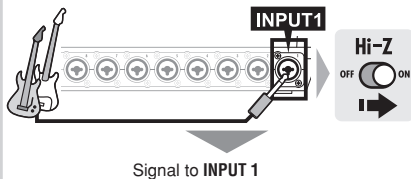

Connecting low-impedance instruments (mono connections)

Connect low impedance instruments to any **INPUT 1-8**.

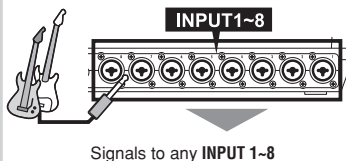

Using phantom power

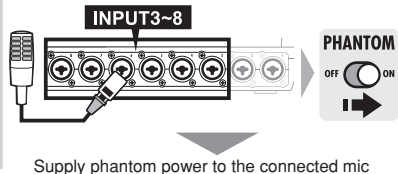

NOTE

- Turn the **PHANTOM** switch **ON** to provide +48 V power to **INPUTS 3-8**.
- In order to reduce battery consumption by the use of phantom power, it can be turned off to **INPUTS 3, 4, 7 and 8**, and the voltage can be reduced to +24 V (Ref. P104).
- Use the fader that is in line with the **INPUT** jack. The signal from **INPUT 1** goes to track 1, 9 or 17.
- To use tracks 9~16 or 17~24 press the **9-16Tr** or **17-24Tr** key to switch the fader assignment.
- Depending on the insert effect selection, the output can change.
- Create one stereo file from two faders by using the stereo link setting.

Assign INPUT 1-8 connections to tracks 1~24

1 Connect instruments and mics.

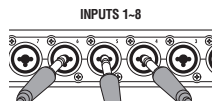

2 Make settings for instruments, built-in mics, stereo tracks, etc.



3 Select the bank of tracks.

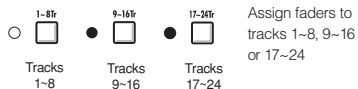

4 Change the status of the connected inputs.

Press the status key of a track 1-2 times to turn its red light on.



Set the tracks to receive inputs

Press the **1-8Tr**, **9-16Tr** or **17-24Tr** key to set the bank of tracks that will record the inputs.

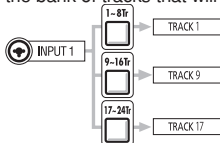

INPUT	TRACK		
	1-8Tr key active	9-16Tr key active	17-24Tr key active
1	1	9	17
2	2	10	18
3	3	11	19
4	4	12	20
5	5	13	21
6	6	14	22
7	7	15	23
8	8	16	24

Connecting instruments/Stereo settings & status keys

To make a stereo recording, set a stereo link for adjacent odd and even-numbered tracks and record on them. Use the status keys to send input signals to recording tracks.

Using the built-in mics



Connecting line input instruments (stereo connection)

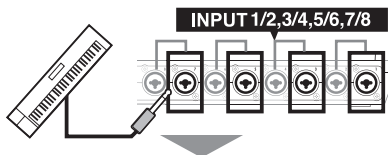

Use **INPUTS 1/2, 3/4, 5/6** and **7/8** as pairs. Input left signals to odd-numbered tracks and right signals to even numbered tracks.

Assign INPUTS 1–8 to tracks 1–8, 9–16 or 17–24.

1 Connect instruments and mics.

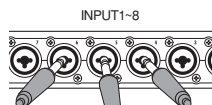

2 Make settings for instruments, built-in mics, stereo tracks, etc.

Stereo

Mono x 2

MIC

3 Select the track bank.



4 Set the status of the connected inputs.

Press a status key of the linked tracks one or two times to turn both lights red.



NOTE

- Use the fader that is in line with the **INPUT** jack. The signal from **INPUT 1** goes to track 1, 9 or 17.
- To use tracks 9~16 or 17~24, press the **9-16Tr** or **17-24Tr** key to switch the fader assignment.

Stereo link

Enable a stereo link for tracks in advance of recording to create a stereo file when recording. You can also assign stereo files.

Status keys and track indicators

Press a status key to set the role of a track fader and change the color of the track indicator light. The track indicator colors show the status as follows.

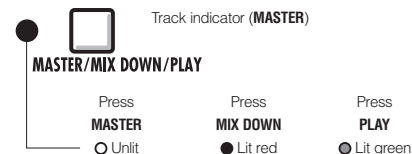
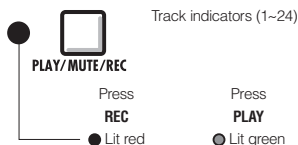
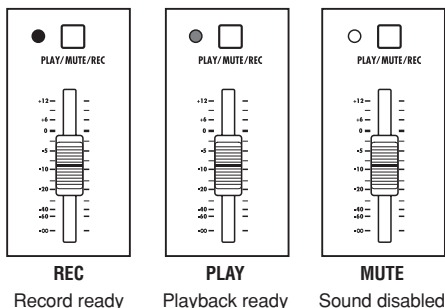

HINT

- In order to send the signal from an **INPUT** to a recording track, press its status key 1–2 times until the track indicator lights red.
- To use two inputs press both status keys to connect both to tracks.
- To create one stereo file when recording two tracks set a stereo link.
- If the **MASTER** track is set to **PLAY**, all other tracks will be set to **MUTE** (no sound).

Stereo link

PAN/EQ>STEREO LINK

- 1 **PAN/EQ**
 Press
 Change tracks
- 2 Select a track.

TRACK1	
PAN	Center
EQ HI	0dB
EQ MID	0dB
EQ LO	0dB
REV SEND	0
- 3 Select **ST LINK**.

TRACK1	
EQ LO	0dB
REV SEND	0
CHO SEND	0
FADER	50
ST LINK	Off

 Change menu
- 4 Select **On**.

TRACK1/2	
EQ LO	0dB
REV SEND	0
CHO SEND	0
FADER	50
ST LINK	On

 On/Off
 The tracks that are joined with a stereo link are shown.

HINT

- The track pairs that can be joined with stereo link are: 1/2, 3/4, 5/6, 7/8, 9/10, 11/12, 13/14, 15/16, 17/18, 19/20, 21/22 and 23/24
- Stereo link changes the setting from two mono tracks to one stereo track.
- Whatever track number you choose, an adjacent track will be linked. You cannot change these combinations.
- To adjust the volume of a pair of tracks joined by stereo link, use the odd number fader. The even number fader has no effect.
- The pan parameter of a pair of tracks joined by stereo link can be used to adjust their relative volume balance.
- Stereo files can be assigned to tracks joined by stereo link. The left channel is sent to the odd track and the right is sent to the even track.

Setting the tempo

Set the tempo for the music. The tempo is saved for each project.

Changing the tempo

1 Press  beneath .

2  Use the dial to change the value.

Tap  beneath  repeatedly.

The average pace will be set as the tempo value.







Tempo	
Range	
40.0~250.0	Default value : 120.0

Preparing a rhythm track

The R24 has a sampler function that allows loops to be played back on each track. Here, we assign a rhythm pattern that is built-in to the R24 to a track as a guide rhythm.

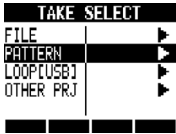
Assignment to a track

- 1 **TRACK**
 Press
- 2 Select the track to assign.

Select track
◀▶
- 3 Select TAKE.

Change menu
▲▼
 Press
- 4 Select PATTERN to use a rhythm pattern.

Change menu
▲▼
 Press
- 5 Select the rhythm pattern.

Select a file or pattern
▲▼
 Press
 

HINT

- You can also play the selected audio file or rhythm pattern.



- If rhythm patterns are assigned to multiple tracks and played back simultaneously, or patterns with numerous note-on events are played, they might not all play as expected due to the maximum polyphony limitation of the unit.
- You can assign the loop files on the USB memory (ref. P49).
- In Step 5, you can change the order of the pattern list.
 Press the **R-2** soft key to list the patterns in alphabetical order.
 Press the **No.** soft key to list the patterns in numerical order.



Recording the first track

After connecting instruments and completing recording preparation, ready the recorder and start recording the first track.

Starting from the Top Screen of a new project

1

Return the counter to the beginning

Press and hold  and press  to return to the beginning.

Top Screen

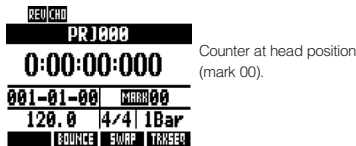

HINT

- The Top Screen display of a new project

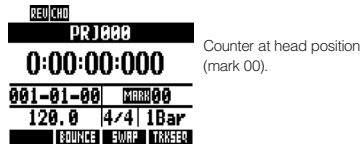

- After setting the input (Step 5 and after), you can process input signals with the insert effect.

 Ref: New project creation
Insert effect

P90

P81

Adjusting the input level

2

Arm the track for recording.

 Press 1-2 times until the track light turns red.
When red, recording is possible

3

Adjust the input sensitivity **GAIN**.

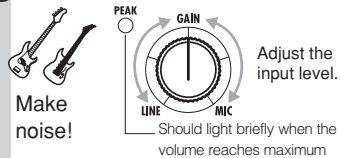

Make noise!

4

Adjust the recording level.

If an insert effect is applied to an **INPUT**, adjust the patch level, for example, so that the red indicator (0dB) on the level meter does not light.

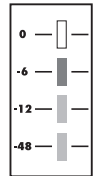

5

Adjust the monitoring system.

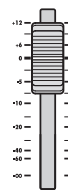

Use the fader for the recording track to adjust the monitoring level of the instrument being recorded (**INPUT 1** is track 1, 9 or 17).

NOTE

Red lights on **PEAK** indicators and level meters
A **PEAK** indicator turns red when the signal exceeds the maximum detectable level of 0 dB, resulting in input clipping. The red indicator on a level meter means that the signal being recorded (signal after passing through the insert effect) is clipping. If clipping happens, the recorded sound will be distorted. You should reduce the recording level.

Recording the first track

6

Start recording standby.



7

Start recording.

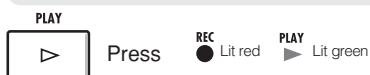

8

Stop recording.

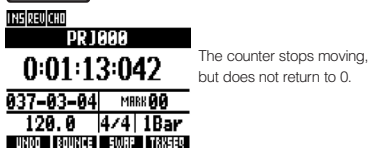

HINT

- Press the UNDO soft key to cancel the operation.

Recording again

- If you record again on the same track, the previous recording will be overwritten.
- There are two ways to make a new recording or re-record.
 - Press the UNDO soft key to undo the recording.
 - Use the TRACK > TAKE > FILE menu to assign the track used for recording to a "New Take" (Ref. P25).

Playing back the recorded track

9

Press stop (if you have not already).

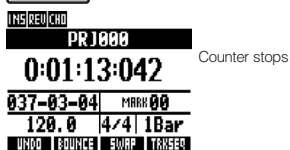

10

Play the track.



11

Return the counter to the beginning.

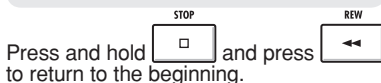

12

Play the track.



13

Stop playback.

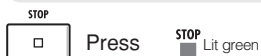

NOTE

- If the REC MODE is set to Overwrite, recorded audio files on tracks will be overwritten when new recordings are made. Be careful when returning the counter to the beginning and recording again. Set the REC MODE to Always New if you do not want to overwrite recordings.
- When set to play, the recording currently on the track will be played.

Changing the playback take

You can assign audio files to tracks freely. By recording multiple takes of vocals, guitar solos and other parts in different files, you can later select the best take.

- 1** TRACK

Press
- 2** Select the track to assign.



Select track



- 3** Select TAKE.



Change menu

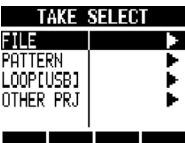

(ENTER) Press
- 4** For an audio file, select FILE.





Change menu

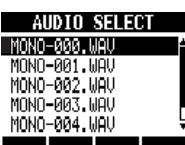

(ENTER) Press
- 5** Select the desired audio file.



Select the file or pattern

(ENTER) Press

HINT

- You can also play the selected audio file.



- Files that are already assigned to tracks have an * to the left of their names.

Switching two tracks (SWAP)

- 1** Press beneath **SWAP**.



- 2** Select the first track to swap.



Indicators blink orange on tracks that can be selected. Press the status key to select a track.



PLAY/MUTE/REC
Selectable: blinking orange
Selected: lit orange
- 3** Select the second track to swap.



Already selected track

Indicators blink orange on tracks that can be selected. Press the status key to select a track.



PLAY/MUTE/REC
Selectable: blinking orange
Selected: lit orange
- 4** Swap the tracks.



Tracks to be swapped

Move cursor



(ENTER) Press

NOTE

The swap function switches two tracks, including the assigned files, track sequence data and all track parameter information.

Recording additional tracks

After recording the first track, you can record additional tracks while playing back already recorded audio. Preparations for recording are the same as for the first track, but you can also set recordings to play on different tracks.

Playing already recorded tracks

- 1**  Press 1-2 times until the indicator lights green for all tracks to be played back.
- Playback-ready when green

Preparing to record more tracks

- 2**  Press for all recording tracks 1-2 times until the track light turns red.
- When red, recording is possible

- 3** Adjust the input level.

 **Make noise!**

PEAK **GAIN** Input sensitivity

LINE **MIC**

Briefly lights when the volume reaches maximum.

Set the level so that at maximum volume the red light (0 dB) does not light.



Recording level

Red	0
Orange	-6
Orange	-12
Green	-48

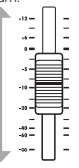
Monitoring system





Start and stop recording

- 4** Press and hold  and press  to return to the beginning.

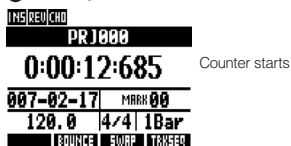

- 5**  +  Press **REC** and **PLAY** in order to start recording.
- REC** Lit red **PLAY** Lit green





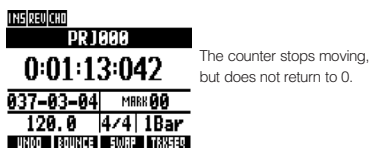



- 6**  Press to stop.
- STOP** Lit green **REC PLAY** Unlit



HINT

- If you want to use a track that has already been recorded on for a later recording, assign the recorded file to another track, and make the target track empty. Refer to "Changing the playback take" (P25). You can also swap recorded tracks with unrecorded tracks. Do this, when creating a second guitar track using Hi-Z, for example.

Playback all tracks

- 1**  Press 1-2 times until the indicator lights green for all tracks to be played back.
Playback-ready when green
- 2** Press and hold  and press  to return to the beginning.
- 3**  Press to start playback.
 Lit green
- 4**  Press to stop playback.
 Lit green

NOTE

- When you move files on tracks, confirm that no files are assigned to the tracks to be recorded ("New Take").
If there is a file assigned to a track, that recording will be overwritten by new recording.
- If the REC MODE is set to **Overwrite**, recorded audio files on tracks will be overwritten when new recordings are made. Be careful when returning the counter to the beginning and recording again. Set the REC MODE to **Always New** if you do not want to overwrite recordings.
- When a track is play-enabled, the file on it will play back.

HINT

- If you are recording on a different track than the first track, there is no need to move or swap the first track.
- If you want to record a new file, set that track to **New Take**.

Automatic punch-in/punch-out

Punch-in and punch-out allow you to re-record a single part of a recorded file. You can set the beginning (punch-in) and ending (punch-out) points in advance to start and stop recording automatically.

Prepare the track that you want to punch-in/punch-out

- 

Raise the fader on the track you want to re-record
- 

Press 1-2 times until lit red

When red, recording is possible
- 

Adjust the recording level and the **GAIN** to be the same as the already recorded part.

Set the punch-in/out points

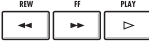
- 

Locate the starting position (punch-in point)
- 

Press to set the punch-in point



Appears on display
- 

Locate the ending position (punch-out point)
- 

Press to set the punch-out point



Appears on display

NOTE

- Once you set auto punch-in/out point, you cannot change them. Cancel and set them again.
- If the **REC MODE** is set to **Always New**, a new file will be recorded.

Rehearse

- 

Press to start playback.

When the punch-in point is passed, the track is automatically muted.
 - 







Press to stop playback.
- Perform (not recording)**
- When the punch-out point is passed, the track is automatically unmuted.

Re-recording: punch-in/punch-out

- 

Locate to before the punch-in point.
- 

Press **REC** and **PLAY** in order to start recording.

 Lit
  Blinks Not recording
 Pass the punch-in point
Perform  Lit Recording
 Pass the punch-out point
 Lit
  Blinks Not recording
- 

Press to stop recorder.

 Unlit

Cancel punch-in/out

- 

Press

Indicators disappear from display

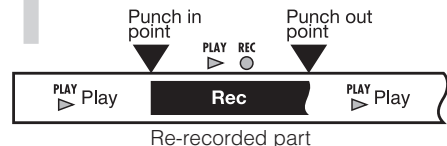













Manual punch-in/punch-out

You can also punch in and out manually. Press the **REC** key during playback to start re-recording from that point.

Prepare the track that you want to punch-in/punch-out

- 1  Raise the fader on the track you want to re-record
- 2  Press 1-2 times until lit red
When red, recording is possible
- 3  Adjust the recording level and the **GAIN** to be the same as the already recorded part.

Re-recording: punch-in/punch-out

- 4  Locate to before the punch in point.
- 5  Press to start playback. 
-  Perform (not recording)
- 6  Press **REC** to punch-in and start recording. 
-  Perform (recording)
- 7  Press **REC** to punch-out, stop recording and start playback.  
- 8  Press to stop recorder. 

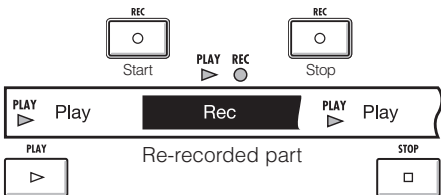

NOTE

- Punch-in/out overwrites the recording on the track.
- If the track is set to **New Take**, the track will be silent before punching in and after punching out.
- If the **REC MODE** is set to **Always New**, a new file will be recorded.
- Use the **UNDO** soft key to cancel the re-recording and keep the previous take.

Project playback

Recorded audio files are assigned to the tracks that they were recorded on.
 All tracks that are enabled for playback by their status keys (green lights on) will be played.

Overview of recording and playback process in a project

TRACK	TRACK	TRACK	TRACK	TRACK	TRACK	TRACK	TRACK	MASTER
1/9/17	2/10/18	3/11/19	4/12/20	5/13/21	6/14/22	7/15/23	8/16/24	TRACK

Recording the first track



Recording more tracks/Playback of the previously recorded tracks

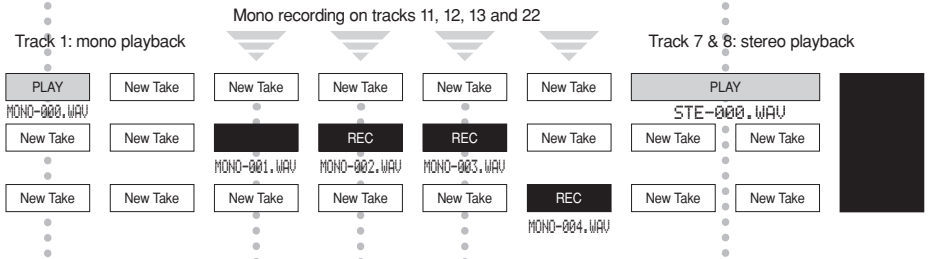

Playback

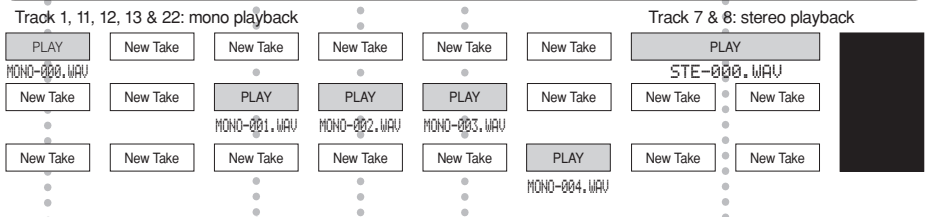

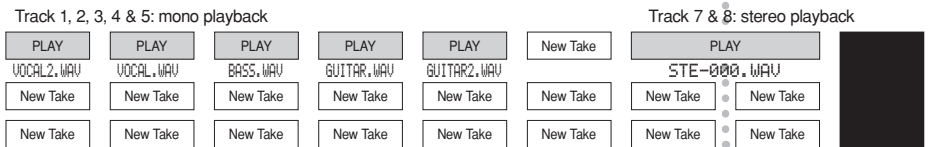

Assigning different files to tracks for playback





Repeat playback of a specific section (A-B repeat)



You can set a beginning point (A) and an ending point (B) in a project and repeat playback between them.

Setting A-B points

1    Locate the beginning point.

2  Press
 Appears on display

3   Locate the end point.

4  Press
 Appears on display

A-B repeat: playback repeatedly

5  Press to start playback.

6  Press to stop playback.

Cancel repeat and clear points

7  Press to cancel repeat playback and clear the A-B points.
 The repeat icons disappear from the display.

HINT

- When playback reaches point B, it automatically goes back to point A and continues playback.
- While the A-B icon appears, playback repeats continuously.
- These settings can be made both during playback and when stopped.
- If you set point B at a time before point A, repeat playback will occur from point B to point A instead.
- To make new settings, press the **A-B REPEAT** key to cancel it once and then follow the procedures to make new ones.

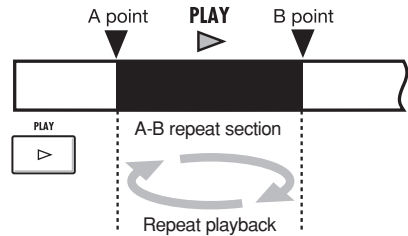

Using the counter and marks to locate

The counter shows the recording or elapsed time in hours: minutes: seconds: milliseconds and bars–beats–ticks (1/48 beat). Set marks in a project to locate to them quickly.

Locate using the counter

To prepare, stop the recorder, select the project and start from the Top Screen.

- Select the hours: minutes: seconds or bars–beats–ticks.

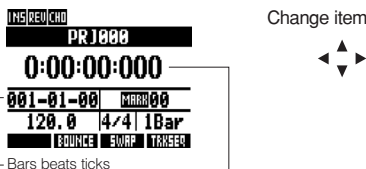

Hours: minutes: seconds: milliseconds

- Change the values.

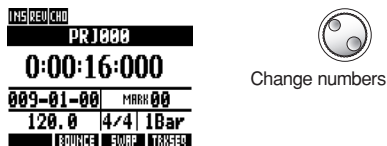

NOTE

You cannot change the counter this way during recording or playback.

HINT

- After Step 2, you can start playback from the set counter position.
- Mark icon display

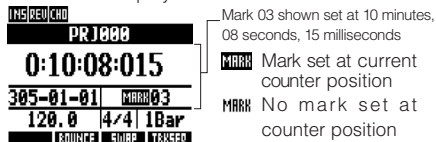

Mark 03 shown set at 10 minutes, 08 seconds, 15 milliseconds

MARK Mark set at current counter position

MARK No mark set at counter position

- Mark zero (MARK00) is always set at counter 0 (project beginning) and cannot be changed.
- If you add a mark at a time earlier than an existing mark, all the following marks will be automatically renumbered in order.
- One project can have a maximum of 100 marks, including the zero mark.

Add a mark

Add a mark using the counter

- Start from the top screen. Set the counter to the desired mark position.

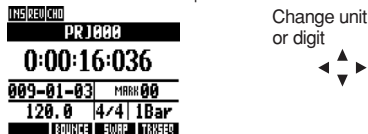

- Press

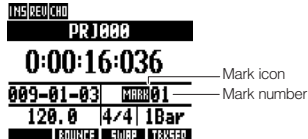

Add a mark during recording/playback

- During recording or playback



- Press



Locate to the position of a mark

Use keys to move between marks in order



Press the forward or backward mark key until you reach the desired mark.



Project

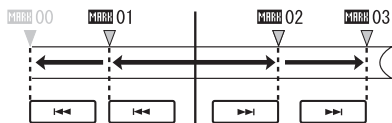

Delete a mark

1



Press the forward or backward mark key until you reach the desired mark.



Mark icon highlighted



Press



The highlighted mark is erased and the preceding mark is shown.

2

Move to marks in counter sequence

1 Select the mark number.



Move between units and digits



Blinks

2

Select a mark number.



Change number

NOTE

- Once deleted, a mark cannot be recovered.
- MARK00** (the project beginning) cannot be erased.
- Press the **MARK/CLEAR** key when the mark icon is highlighted (light letters on dark background) to erase that mark. Press the **MARK/CLEAR** key when the mark icon is not highlighted to create a new mark at that position.
- When marks are added and removed between other marks, all the marks are automatically renumbered in order from the beginning.

New mark added

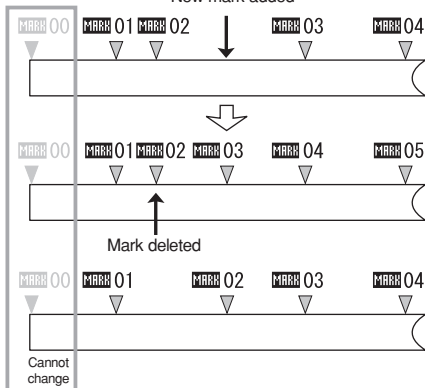



Metronome

This metronome, which includes a pre-count function, allows you to change its volume, tone and pattern. You can also output the metronome sound only through the headphones.

1 **TOOL** Press 

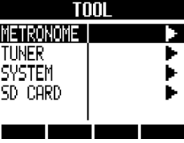

2 Select **METRONOME**.

 Change menu 

 Press

This is the standard method for setting the metronome.

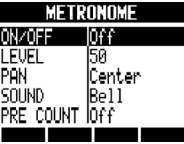
3 Select each menu and adjust the settings.

 Change menu 

 Change setting

HINT

Changing and adjusting the metronome output

- Use the **METRONOME** switch to set the output.

 **METRONOME** switch: OUTPUT + PHONES (left), PHONES ONLY (right)

 **BALANCE** knob: MASTER (left), CLICK (right), DAW (bottom)

OUTPUT + PHONES

The metronome sound is output through both **OUTPUT** and **PHONES** jacks

PHONES ONLY

The metronome sound is output only through the **PHONES** jack. Use the **BALANCE** knob to adjust the relative volumes of the **MASTER** fader signal and the metronome sound.

MASTER  **CLICK** (metronome)

- Metronome settings are saved for each project.
- You can use the metronome even during **MASTER TRACK** playback.

Menu settings and setting values

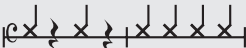
ON/OFF: Set when operative	
Settings	
Play Only	During playback only
Rec Only	During recording only
Play & Rec	During both playback and recording
Off (default)	No metronome sound
LEVEL: Change metronome volume	
Setting range	
0-100	Default value: 50
PAN: Change the stereo position	
Setting range	
L100-R100	Default value: Center
SOUND: Change tone	
Settings	
Bell (default)	Metronome sound with a bell on the accent
Click	Click sound only
Stick	Drum stick sound
Cowbell	Cowbell tone
Hi-Q	Synthesized click sound
TRACK1-TRACK24	TRACK 1-24 sound (mono)
TRACK1/2-TRACK23/24	TRACK 1/2-23/24 sound (stereo)
PRE COUNT: Pre-count setting	
Settings	
Off (default)	No sound
1-8	Enable sound during pre-count for 1 to 8 beats.
SPECIAL	Special pre-count pattern
	

NOTE

- Be aware that if you turn the metronome volume up high, the accented beat of some sounds might become difficult to distinguish.
- If a track with a rhythm pattern assigned is selected in the **SOUND** setting, no sound will be output.

16-track synchronized recording with two units

If you want to record more than 8 tracks at the same time during a band performance, for example, you can increase the number of tracks by connecting two R24s units by USB.

Make sender settings

Set the R24 to use for key control as the master.

- TOOL** Press

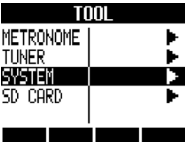

Change menu
- Select **SYSTEM**.



Change menu

Master/Slave
- Select **SYNC REC** and set it to **Master**.

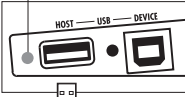

HOST USB indicator lit

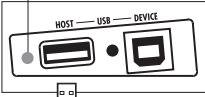
- Connect the two R24 units by USB cable

Plug a USB 2.0 (AB-type) cable into the ports that have lit indicators.

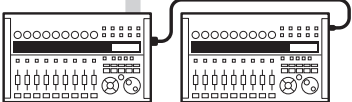

Make receiver settings

Set the R24 that will receive commands as the slave.

- TOOL** Press

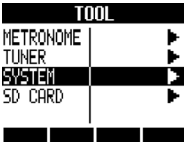

Change menu
- Select **SYSTEM**.



Change menu

Off/Master/Slave
- Select **SYNC REC** and set it to **Slave**.

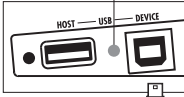

DEVICE USB indicator lit

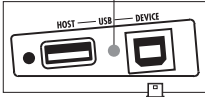



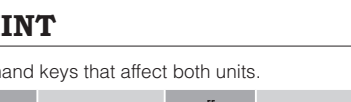

- Connect the two R24 units by USB cable

Plug a USB 2.0 (AB-type) cable into the ports that have lit indicators.



HINT

Command keys that affect both units.

	REC key		FF key
	PLAY key		REW key
	STOP key		



NOTE

- Perfect synchronization of the starting time of recording of two units is not guaranteed. A gap of approximately 1-2 ms will occur.
- Connection with an R16 is also possible. When connecting to an R16, always set the R24 as the **Master**.
- Pre-count is disabled when using synchronized recording.
- When an R24 is set to **Slave**, operation using bus power is not guaranteed. Use an AC adapter or batteries.

R24 mixing process

Use the track mixer to make stereo link settings, adjust volume, EQ, pan (balance) and the send amount to send-return effects.

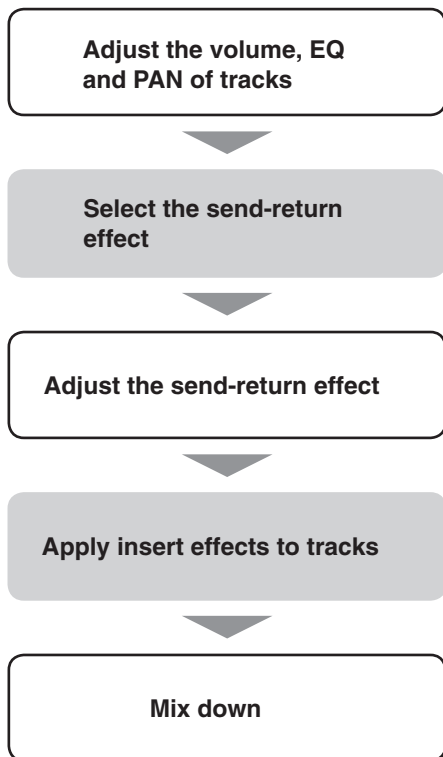

NOTE

Except for phase settings, both left and right channels of stereo tracks share the same parameter values.

HINT

What is the track mixer?

- Use the mixer to mix the recorder's audio tracks to stereo.
- Use each track's fader to adjust its volume, pan, EQ and other parameters.

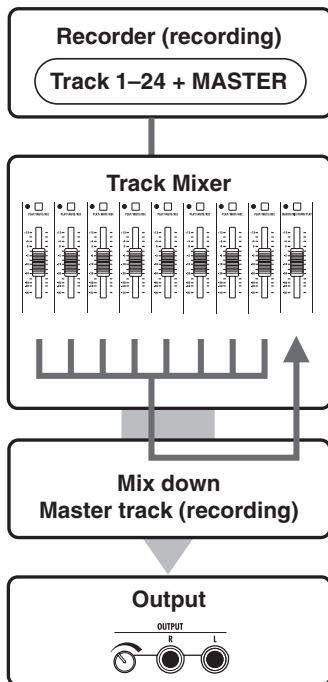

EQ, pan and send level track settings

Use the track mixer to set track parameters that, for example, adjust pan (stereo position), EQ (equalizer) and send-return effects.

1 **PAN/EQ**  Press



2 Select a track.

TRACK1	
PAN	Center
EQ HI	0dB
EQ MID	0dB
EQ LO	0dB
REV SEND	0

Change tracks 



3 Select a menu item and its setting.

TRACK1	
PAN	Center
EQ HI	0dB
EQ MID	0dB
EQ LO	0dB
REV SEND	0

Change menu 

 Change setting



4 Select EQ HI, EQ MID or EQ LO.

TRACK1	
PAN	Center
EQ HI	0dB
EQ MID	0dB
EQ LO	0dB
REV SEND	0

Change menu 
 Press

5 Select each item and change settings.

EQ HI	
TYPE	EQ HI
GAIN	0dB
FREQUENCY	8.0kHz

Change menu 

 Change setting

HINT

- Use the track mixer to adjust each track parameter, including pan and the send-return effect levels, to process the signals.
- In step 2, you can also select a track by pressing its status key so that its indicator lights orange.

NOTE

- Except for phase settings (INVERT), both left and right channels of stereo tracks share the same parameter values.
- Settings are stored separately for each project.
- The only setting that the **MASTER TRACK** has is volume control using its fader.

Track parameters

These parameters can be set for each track

Mono tracks: 1~24
Stereo tracks: 1/2--23/24

Display	Parameter	Setting range (default value)	Explanation	Mono tracks	Stereo tracks	Master track
PAN	PAN	L100~R100 (Center)	Adjusts a track's PAN. For stereo tracks adjusts the volume balance between the left and right channels.	○	○	
EQ HI	High-frequency range boost/cut					
EQ HI	TYPE	EQ HI, HI CUT (EQ HI)	Set whether to boost/cut the high-frequency range (EQ HI) or clearly cut unnecessary high frequencies (HI CUT). This parameter can only be accessed when EQ HI is ON.	○	○	
	GAIN	-12dB~12dB (0dB)	Adjust amount of boost/cut of high frequencies by -12 ~ +12 dB. This parameter is shown only when the TYPE is set to EQ HI. When set to HI CUT, it is not shown.	○	○	
	FREQUENCY	500Hz~18kHz (8.0kHz)	Adjust EQ boost/cut frequency of high frequencies. This parameter can only be accessed when EQ HI is ON.	○	○	
EQ MID	Middle-frequency range boost					
EQ MID	GAIN	-12dB~12dB (0dB)	Adjust amount of boost/cut of medium frequencies by -12 ~ +12 dB. This parameter can only be accessed when EQ MID is on.	○	○	
	FREQUENCY	40Hz~18kHz (1.0kHz)	Adjust EQ boost/cut frequency of medium frequencies. This parameter can only be accessed when EQ MID is on.	○	○	
	Q	0.1~2.0 (0.5)	Adjust the width of the medium frequency band affected. This parameter can only be accessed when EQ MID is on.	○	○	
EQ LOW	Low-frequency range boost/cut					
EQ LO	TYPE	EQ LO, LO CUT (EQ LO)	Set whether to boost/cut the low-frequency range (EQ LO) or clearly cut unnecessary low frequencies (LO CUT). This parameter can only be accessed when EQ LO is on.	○	○	
	GAIN	-12dB~12dB (0dB)	Adjust amount of boost/cut of low frequencies by -12 ~ +12 dB. This parameter is shown only when the TYPE is set to EQ LO. When set to LO CUT, it is not shown.	○	○	
	FREQUENCY	40Hz~1.6kHz (125Hz)	Adjust EQ boost/cut frequency of low frequencies. This parameter can only be accessed when EQ LO is on.	○	○	
Send-return effect levels						
REV SEND	REVERB SEND LEVEL	0~100 (0)	Adjust the signal level sent from the track to the reverb effect.	○	○	
CHO SEND	CHORUS/ DELAY SEND LEVEL	0~100 (0)	Adjust the signal level sent from the track to the chorus/ delay effect.	○	○	
FADER	FADER	0~127 (100)	Adjust the current volume.	○	○	○
ST LINK	STEREO LINK	On/Off (Off)	Switch on/off to set the stereo link function that connects two mono tracks together. (Ref. P.20)	Off	○	
INVERT	INVERT	On/Off (Off)	Set whether the phase of a track is inverted or not. Set it to Off to use normal phase or ON to invert the phase.	○	○	

NOTE

- Use the **ON/OFF** soft key to turn **EQ HI**, **EQ MID**, **EQ LO**, **REV SEND**, **CHO SEND** and **INVERT** parameters ON/OFF.
- When a stereo link is ON, the **INVERT** parameter is shown as **INVERT L** for the odd track, and as **INVERT R** for the even track.

Combine multiple tracks into 1–2 tracks

Bounce to combine multiple tracks into one new mono or stereo file in the same project.

Bounce destination track settings

PROJECT>REC>BOUNCE TR

Start from the Top Screen

- 1 **PROJECT**
 Press
- 2 Select REC.

PROJECT	
RENAME	
PROTECT	Off
FILE	
REC	
SEQ PLAY	

Change menu
▲▼

Press
- 3 Select BOUNCE TR.

REC SETTING	
BIT LEN	16bit
BOUNCE TR	Mute
REC MODE	Overwrite

Change menu
▲▼

To include the signal of the track that is overwritten by the bounce in the bounce.

- 4 Select Play.



REC SETTING	
BIT LEN	16bit
BOUNCE TR	Play
REC MODE	Overwrite

Change setting

BOUNCE TR: bounce destination track	
Setting	
Mute	Mute the bounce destination track (default value)
Play	Play bounce destination track

- 5 Return to the start of the project.

Bounce (preparation)

- 1 Select the bounce source tracks (set each track to play back).
 Press 1–2 times until indicator lights green
PLAY/MUTE/REC
Playback-ready when green
- 2 Select bounce destination track(s).
 Press 1-2 times until the track light turns red.
PLAY/MUTE/REC
When red, recording is possible

HINT

- “Bouncing” means combining audio data from several tracks and files together into one stereo or mono file. This is also called “ping-pong recording.”

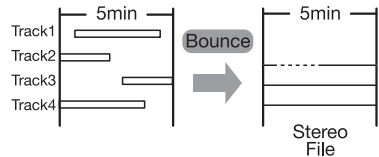

- To also play (and include in the bounce) the signal of the bounce destination track, set BOUNCE TR to Play as described in Step 4 of “Bounce destination track settings”.
- A new file will be created in the same project.
- If you set the bounce destination to a mono track, the recorded signals are mixed to mono. If set to a stereo linked pair of tracks, the recorded signals will be mixed to stereo.



Bouncing

3 Press  beneath **BOUNCE**.



BOUNCE ON appears on the display

Note: Press the BOUNCE soft key again to cancel bounce mode.

4 Press and hold  and press  to return to the beginning.

5  +  Press in order to start recording.
 Lit red  Lit green

6  Press to stop recording.

Adjust the mix balance (audition)

1  Press to start playback.

2 Adjust the mix balance, including level, volume, pan and EQ settings, for each track.

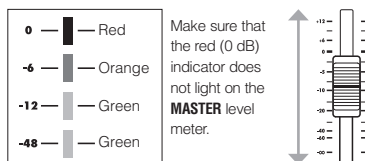

3  Press to stop.



Playback the track after bouncing

1 Enable playback of the bounce destination tracks.

 Press 1–2 times until indicator lights green
PLAY/MUTE/REC
 Playback-ready when green

2 Disable playback of the bounce source tracks.

 Press 1–2 times until unlit
PLAY/MUTE/REC
 Muted when unlit

3 Press and hold  and press  to return to the beginning.

4  Press to start playback.

NOTE

- This operation can be undone by pressing the UNDO soft key.
- If you bounce in stereo to two mono tracks, the pan of the odd number track will be set to L100, and the even number track will be set to R100.

Using a mastering effect



Use a mastering algorithm as an insert effect on the master track before recording to process the mix down.

Insert an insert effect before the MASTER fader



- 1 EFFECT**

Press
- 2** Select **ON/OFF** and set it to **On**.



INSERT EFFECT	
ON/OFF	On
ALGORITHM	Clean
PATCH	No.00 Z CL
INPUT SRC	Input1
EDIT	
INSERT	REVERSE
CHORUS	

Change menu 
Change setting 
- 3** Select **ALGORITHM** and set it to **Mastering**.

INSERT EFFECT	
ON/OFF	On
ALGORITHM	Mastering
PATCH	No.00 Plus
INPUT SRC	Input1/2
EDIT	
INSERT	REVERSE
CHORUS	



Change menu 
Change setting 
- 4** Select **INPUT SRC** and set it to **Master**.

INSERT EFFECT	
ON/OFF	On
ALGORITHM	Mastering
PATCH	No.00 Plus
INPUT SRC	Master
EDIT	
INSERT	REVERSE
CHORUS	

Change menu 
Change setting 
- 5** Select **PATCH** and set it.

INSERT EFFECT	
ON/OFF	On
ALGORITHM	Mastering
PATCH	No.00 Plus
INPUT SRC	Master
EDIT	
INSERT	REVERSE
CHORUS	

Select a patch while playing the project.
(Listen to the effect that the patch has on the project and choose one you like.)

PLAY  STOP 
- 6**  Press

NOTE

- When the insert effect is applied before the **MASTER** fader in advance, the insert effect cannot also be applied to tracks, either during recording or playback.
- At step 5, if you notice distortion because of the mastering effect, check the sound of the playback tracks by lowering their faders. (If a track sound is distorted, adjust that track.)
- You can select **Stereo**, **Dual**, **Mic** or **Mastering** algorithms. If you set another algorithm, the insert position changes to the inputs.

HINT

You can also select a **MASTERING** algorithm to process a stereo mix.

Recording signal flow to the master track

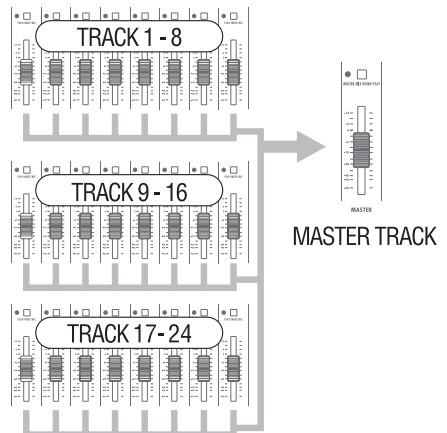



Recording to the master track

Record a "final" stereo mix as a mix down on the **MASTER** track.
 Signals are sent to the master track after passing through the **MASTER** fader.

Recording to the MASTER track

Prepare by adjusting the signal levels.

1 Press and hold  and press  to return to the beginning.

Then, press  to start playback, and adjust the levels of each track.

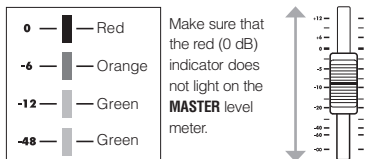

2 Adjust the level of the signal that passes through the master fader.



3  Press to stop.

Record to the master track

4 Press the **MASTER** status key 1-2 times until the indicator **MASTER/MIX DOWN/PLAY** lights red.
When red, recording is possible

5 Press and hold  and press  to return to the beginning.

6  +  Press in order to start recording.

7  Press to stop.

NOTE

The settings of the pan, balance, insert and send-return effects of each track affect the signals sent to the **MASTER** track.

Play the master track

1 Press the **MASTER** status key 1-2 times until the indicator **MASTER/MIX DOWN/PLAY** lights green.
Playback-ready when green
 Doing this mutes all other tracks and disables all effects.

2 Press and hold  and press  to return to the beginning.

 Press to start playback.

3  Press to stop.

Disable **MASTER** track playback

4 Press the **MASTER** status key 1-2 times until the indicator is unlit.
Unlit means it is disabled
 Muting of the other tracks is canceled and their status lights become as they were before.

HINT

- Each project can have one **MASTER** track.
- A file can be assigned to the **MASTER** track.
- If you mix down from the middle of a song, it will always be recorded to a new file.
- During recording, you can check the playback levels of each track and the recording level of the **MASTER** track.
- The signals that have passed through the **MASTER** fader are the same as those sent from the **OUTPUT** jacks.
- This operation can be undone by pressing the **UNDO** soft key.
- You can use the metronome during playback.

 Ref: Sequential playback of projects

Using the sampler to make songs

Use the sampler functions of the R24 to easily create backing tracks, rhythm parts and other basic tracks that have high sound quality. These features can be used to make a wide variety of music, from demo songs to produced recordings.

1 Make a loop to provide the basic rhythm of the entire song.

You can assign a rhythm made with loops and the unit's rhythm functions to a track (pad) and set it to loop. You can develop a vision for an entire song by selecting drum loops, for example, and other materials that inspire you.

 Ref: Assigning tracks
Loop settings

P49

P50

2 As you listen to the rhythm loop that you prepared, record guitar, bass, keyboard and other instruments to create more loop materials.

Keep recording until you are satisfied with the performance of the riff, backing part or other musical phrase. You can loop only the parts of the recordings that you like.

 Ref: Loop settings

P50

3 Repeat step 2 to record other phrases to use as loops.

Prepare all the phrases that are necessary to make your song.

4 When the loops are ready, play them with the pads and think about the structure of the entire song.

Play the pads with the rhythm and think about the flow of the entire song and how to put the loop materials together.

 Ref: Playing the pads

P52

5 After you have determined the structure of the song, create the sequence (loop performance data for the entire song).

A sequence can be input by playing the pads along with a rhythm (click) in real time or step by step (step input). Doing this, you can complete the basic tracks, including backing parts and the rhythm for an entire song.

 Ref: Creating a sequence

P53

6 Record vocals, guitar solos and other parts as you listen to the sequence.

Record the main vocals and instruments in time with the basic tracks.

Overview of sampler functions

With the R24, you can assign audio files and rhythm patterns to tracks, which can then be played back and played in real time using the pads.

The following settings can be made related to playing the pads.

- Pad playback types
- Global quantization to fix timing errors

You can also set the R24 to loop an audio file assigned to a track. The starting point and length of a loop can be set.

In addition, audio files and rhythm patterns that have been assigned to tracks and set to loop can be used to create a sequence, including backing parts and rhythms for an entire song.

A sequence can be input by playing the pads along with a rhythm (click) in real time or step by step (step input).

Bars and beats can be inserted and deleted, and the time signature can also be changed.

Audio files assigned to tracks can also be altered, including by changing their tempo without changing the pitch, deleting unnecessary parts, applying fade-ins and fade-outs and changing the tempo (BPM).

Assigning tracks



To use the sampler function, first assign audio files and rhythm patterns to tracks. In this example, we explain how to assign loops stored on the USB memory.

To add loops to the USB memory, use the STORAGE>INIT option from the USB menu and then put loops into the folder ZOOM_R24/LOOP (Ref. P109).

1 **TRACK**
 Press



2 Select the track to assign.



Select track
 

3 Select TAKE.





Change menu
 

 Press

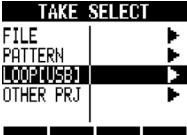
4 Select LOOP[USB].





Change menu
 

FILE	Audio files in the current project
PATTERN	Rhythm pattern
LOOP[USB]	Loops on the USB memory
OTHER PRJ	Audio files in other projects

 Press

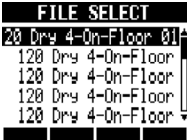
5 Select a loop.



Select file
 

 Press

NOTE

- To load an audio file from another project, select OTHER PRJ in step 4. From PROJECT, select the project that contains the file. Then, from NEXT, select the file. Change the file name if necessary before loading it.
- In a new project, the BPM (tempo) of the first audio file assigned to a track sets the BPM of the project.
- In the LOOP[USB] menu, you can see the files in the ZOOM_R24/LOOP folder on the USB memory. To use a new USB memory device, create a folder with the same name on the memory using a computer (Ref. P109), or use the STORAGE>INIT option from the USB menu, and then put loops into the folder.
- If rhythm patterns are assigned to multiple tracks and played back simultaneously, or patterns with numerous note-on events are played, they might not all play as expected due to the maximum polyphony limitation of the unit.
- In step 2, you can also select tracks by pressing their status keys.

HINT

You can also play audio files and rhythm patterns as you select them.

 **Start playback**

 **Stop playback**

Loop settings

Make loop settings separately for each track.
Turn loops ON and set their starting points and lengths.

Setting tracks to loop

Turn loops ON and OFF for each track.

1 **TRACK**
 Press

2 Select the track to be looped.



3 Select LOOP.



Press

4 Select ON/OFF, and set it to ON to enable loop playback.

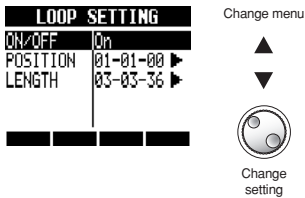

NOTE

- The status key indicator of a track with LOOP set ON lights orange instead of green when enabled for playback. Moreover, a track with LOOP set ON cannot be used to record (the indicator will not be lit red). In addition, the following functions can be used when a track has LOOP set ON.
 - The pad can be used to trigger the loop.
 - Pressing the PLAY key starts loop playback.
 - Sequence data can be recorded.
- When a rhythm pattern is assigned to a track, it cannot be set to loop.
- In step 2, you can also select tracks by pressing their status keys.

Loop settings

Setting the loop interval

The loop interval (starting point and length) can be set for tracks that have audio files assigned and LOOP set to ON.

1 **TRACK**
 Press

2 Select the track to be looped.



Select track

3 Select LOOP.



Change menu

 Press

4 Select POSITION.

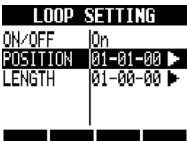

Change menu

 Press

5 Set the loop starting point.

Starting point



Locate

Change starting point

6 Press  beneath **LENGTH** to set the length of the loop.

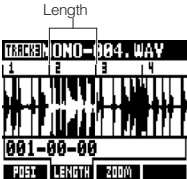



Locate

Change length

HINT

- When setting the loop starting point and length you can switch between the POSI and LENGTH soft keys.
- You can also play the audio file that you are setting.

 Start playback

 Stop playback

 Fast forward

 Rewind

Zooming in on the waveform

When setting the loop starting point and length, you can zoom in on the waveform that is displayed. Zooming up to 32x is possible.

Press  beneath **ZOOM** to zoom.



Change zoom

Playing the pads

Press the pad beneath a fader to play the audio file or rhythm pattern assigned to that track.

1 Press a pad

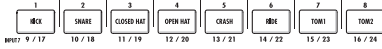

MASTER REPEAT/STOP Press a pad while holding **REPEAT/STOP** to enable loop playback (if PAD is set to 1Shot).

MASTER REPEAT/STOP Press a pad again while holding **REPEAT/STOP** to stop loop playback.

Setting the playback method

Set how the pads function when played.

1 TRACK
 Press

2 Select PAD and set the playback method.

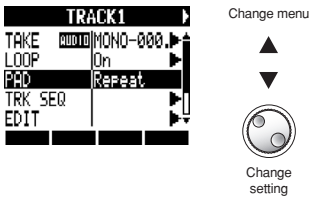

PAD: playback method	
Setting	
Repeat	Play loop repeatedly
Gate	Stop playback as soon as the pad is released
1Shot	Play the file once completely even if the pad is released

Set global quantization

The unit can be set to correct timing errors when playing the pads or inputting sequence data in real time so that sounds are aligned with bars and beats.

Move the cursor to the global quantization display area and adjust the setting.

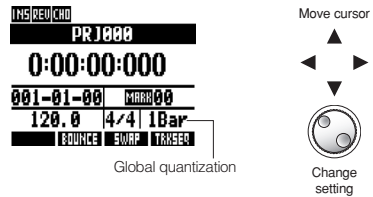

Global quantization	
Settings	
8Bars, 4Bars, 2Bars, 1Bar (default value)	8 bars, 4 bars, 2 bars, 1 bar
1/2, 1/2T, 1/4, 1/4T, 1/8, 1/8T, 1/16, 1/16T, 1/32	Half-note, half-note triplet, quarter-note, quarter-note triplet, eighth-note, eighth-note triplet, sixteenth-note, sixteenth-note triplet, thirty-second note
Hi	1 tick (1/48 of a quarter-note)

NOTE

- When you press a pad, the sound will be delayed until it is in time with the set quantization (bar, note).
- The pad blinks during playback.
- When you stop playback, the operation is delayed until it is in time with the set quantization (bar, note).

Creating a sequence

Assign audio files and rhythm patterns to tracks and set their LOOP settings to ON. Combine them to create backing parts, rhythms and other data (sequence data) for an entire track. A sequence can be created with real-time input or step input.

Create a sequence with real-time input



With real-time input, you can create a sequence by playing the pads in time with the rhythm (metronome).

1 TRACK
 Press

2 Select TRK SEQ.



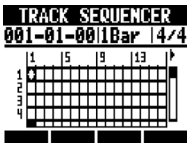

 Press

3 Start real-time input by pressing and holding  and pressing .

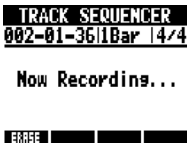

4 Play the pads in time with the rhythm to input data.



5 To delete input, press and hold  beneath **DELETE**. Data that has already been input for a track will be deleted while its pad is being pressed.

6  Press to end input.

NOTE

- If your timing is slightly off, it will be corrected in accordance with the quantize setting
- A metronome pre-count can also be set (Ref. P36).

Create a sequence using step input

A sequence can be created one step at a time using step input.

1 **TRACK**
 Press

2 Select TRK SEQ.



Change menu



(ENTER) Press

3 Start step input.

REC
 Press

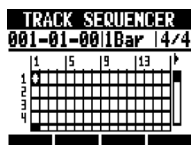

4 Move the cursor to the position where you want to input or delete data.

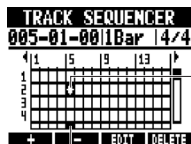

Move cursor



Cursor

Bar cursor

REW
 Go back 1 step

FF
 Go forward 1 step

Press beneath **+** or **-** to change the length of one step to a bar, beat or 16th note.

5 Press a pad to input that pad's data at that position.

Or, press **ENTER** to input the data of that track at that position.

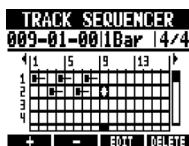

Note-on



Length of loop or rhythm pattern

6 To delete input, press beneath **DELETE** to delete data at that position.

7 **STOP**
 Press to end input.

Creating a sequence

Deleting data

When using step input, you can delete data before and after the cursor position together.

- 1 Move the cursor to the position of data that you want to delete.

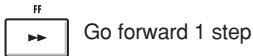
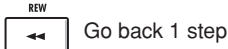
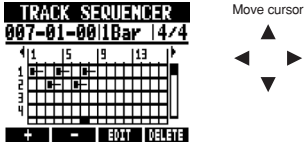

- 2 Press beneath **EDIT**.

- 3 Select DEL EVENT.



- 4 Select MODE and set it to Before or After to delete data to the left or right of the cursor.



- 5 Select EXECUTE.



Editing a sequence

When creating a sequence by step input, you can insert and delete beats. You can also change the time signature.

Inserting and deleting beats

When using step input for a sequence, you can insert and delete beats.

You can insert and delete a number of beats that differ from the project time signature, changing the time signature for only that part.

Start step input.

1

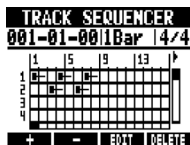

2

Press beneath **+** or **-** to change the length of one step.

3

Move the cursor to the position where you want to insert or delete beats.

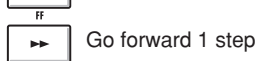
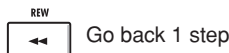
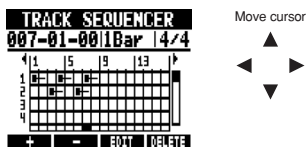

4

Press beneath **EDIT**.

5

Select **INS BEAT** to insert beats or **DEL BEAT** to delete beats.



6

Select **BEAT** and set the number of beats that you want to insert or delete.



7

Select **SIGNATURE** and set it to **No** to not change the time signature or **Add** to change the time signature.

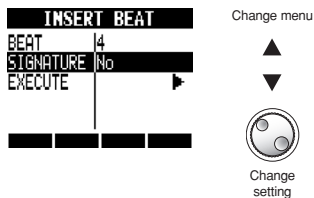

8

Select **EXECUTE**.

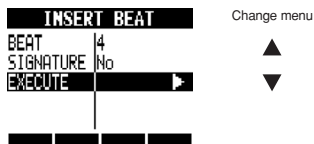

Editing a sequence

NOTE

- When you insert beats, the sounds of loops and files playing back will be cut at that point.

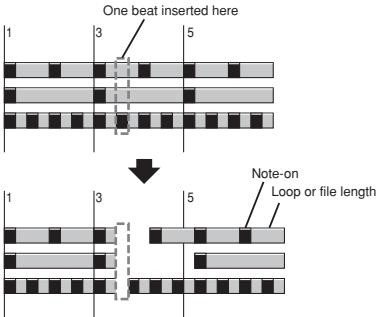

- When you delete beats, the sounds of loops and files playing back at that time will become shorter by the same amount.

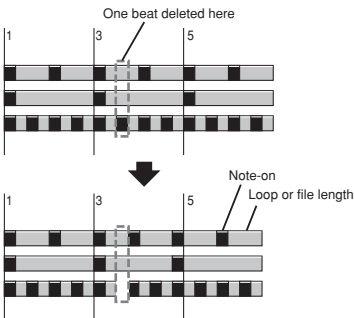

- If you insert or delete beats that differ from the set time signature, the time signature for that part might change depending on the SIGNATURE setting.

SIGNATURE: time signature setting	
Setting	
No	<p>The time signature does not change. The beats are shifted by the amount inserted or deleted.</p> <ul style="list-style-type: none"> If you insert beats, the time signature of the bar that contains the last inserted beat will change. For example, if 3 beats are inserted into a song with a 4/4 time signature, the bar where the 3rd beat is added will become 7/4. <p>4/4 1 2 3 4</p> <p>Three beats inserted here</p> <p>4/4 7/4 4/4 4</p> <p>1 2 3 4</p>
Add	<ul style="list-style-type: none"> If you delete beats, the time signature of the bar that they are deleted from will change. For example, if 3 beats are deleted from a song with a 4/4 time signature, that bar will become 5/4. <p>4/4 1 2 3 4</p> <p>Three beats deleted here</p> <p>5/4 4/4 4</p> <p>1 2 3 4</p> <ul style="list-style-type: none"> The time signature of only 1 bar changes, time signatures of other bars do not change.

Changing the time signature

During step input of a sequence, you can also change the time signature.

1 Start step input.

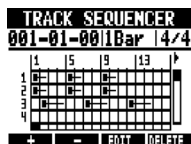

2 Move the cursor to the position where you want to change the time signature.

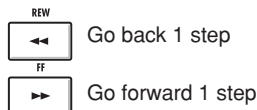
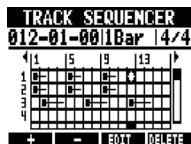

3 Move to the time signature indication area, and change the setting

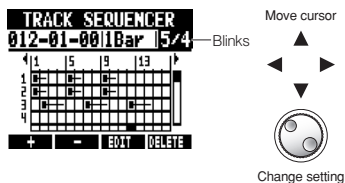

Changing the time signature	
Setting range	
1/4-8/4	Time signature

Delete an inserted time signature

1 Move the cursor to the position where you want to delete the time signature

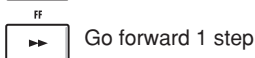
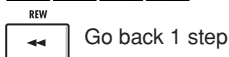
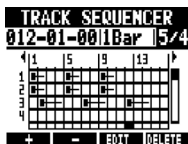

2 Move to the time signature indication area.







3 Press  beneath **DELETE**.



Playing back a sequence



Use the following procedures to play back the sequence that you made.

Playback from the sequencer

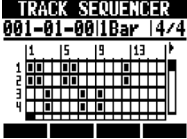
- 1 **TRACK**
 Press



- 2 Select TRK SEQ.
 Change menu

 Press

- 3 **PLAY**
 Press

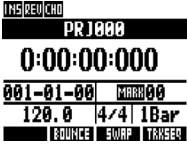
 Press to stop

 and press  to return to the beginning.



Playback from the Top Screen

- 1 Press  beneath **TRACK** to turn the track sequence ON/OFF.

- 2 **PLAY**
 Press

 Track sequencer ON
 Press to stop

 Press to fast forward

 Press to rewind

 and press  to return to the beginning.

Changing the BPM

The BPM of each track is automatically calculated when an audio file is assigned to it. Depending on the material, however, the calculated result might differ from the actual BPM. If this occurs, use the following procedures to adjust the BPM. The set BPM is used as the standard tempo when changing the tempo of the audio without changing its pitch.

1 **TRACK**
 Press

2 Select the track where you want to change the setting.



3 Select BPM and change the setting

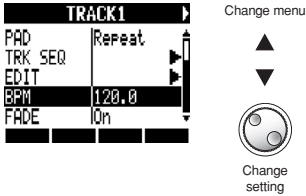

NOTE

- BPM is calculated for an audio file assuming 4/4 time.
- When a track is recorded, the current BPM value is used.

Changing audio tempo without changing pitch

When an audio file is assigned to a track, you can change the tempo of audio without changing its pitch (time-stretching). You can change all tracks at once or individual tracks. Be aware that this operation will overwrite the original audio file.

1 **TRACK**
 Press

2 To change one track at a time, select a track.



3 Select **EDIT**.



 Press

4 Select **STRETCH**.

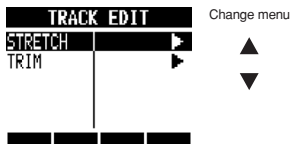

 Press

5 Select **MODE** and set it to **Each** to change only the current track or **All** to change all the tracks.

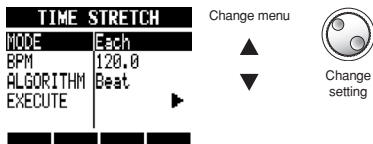

6 Select **BPM** and the new tempo after time-stretching.

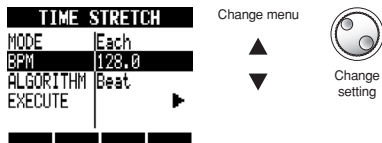

7 Select **ALGORITHM** and set it to the one most appropriate for the audio file

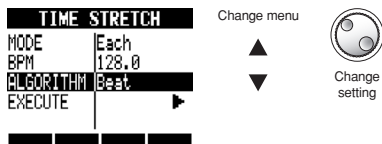

ALGORITHM	
Setting	
Beat	Stretching algorithm suitable for rhythm sources and other sounds that have short notes
Tone	Stretching algorithm suitable for songs and sound sources with long notes

8 Select **EXECUTE**.



 Press

9 Select **YES**.

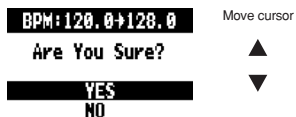

 Press

NOTE

- **STRETCH** operations cannot be undone (**UNDO**).
- **STRETCH** operations overwrite the original audio files. If you want to save the original files, make a copy of the project and files in advance (Ref. P93).
- The BPM of each track is automatically calculated when an audio file is assigned. Depending on the file material, however, the calculated result might differ from the actual BPM. Set the BPM of each track (**TRACK > BPM**) if this occurs (Ref. P60). The set BPM is used as the standard tempo when changing the tempo without changing the pitch of the audio..
- The tempo of an audio file can be set to from 50%~150% of the original. If the stretched tempo value is outside this range, an error message appears, "TRACK X is out of the setting range" (X is the track number) and stretching is stopped.
- If a rhythm pattern is assigned to a track, the rhythm pattern screen opens after Step 3.

HINT

You can listen to a preview of the results of time-stretching for individual tracks.

PLAY



Press to play the preview

STOP



Press to stop the preview

Trimming unnecessary parts of audio files

By trimming, you can delete audio data that is outside bounds that you set to change the starting and stopping points of the file. This operation overwrites the original audio file.

1 TRACK
 Press

2 Select the track that you want to trim.



3 Select EDIT.



Press

4 Select TRIM.



Press

5 Set the starting point

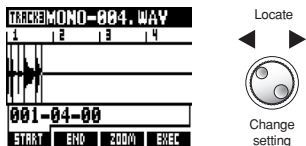

6 Press beneath **END** to set the ending position.

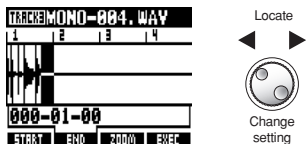

7 Press beneath **EXEC**.

8 Select YES.

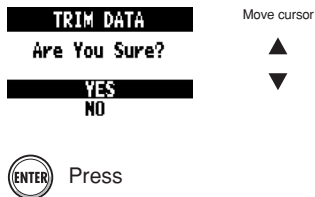

NOTE

- The TRIM operation cannot be undone (UNDO).
- The TRIM operation overwrites the original file. If you want to save the original files, make a copy of the project and files in advance (Ref. P93).
- If a rhythm pattern is assigned to a track, the rhythm pattern screen opens after Step 3.

HINT

- The trim starting and ending points can be adjusted alternately by using the START and END soft keys.
- Use the ZOOM soft key to view the waveform more closely.
- You can also play the audio file while setting its starting and ending points.

Start playback

Stop playback

Fast forward

Rewind

+ Return to starting point

Setting fade-ins and fade-outs

When playing normal audio files, short fade-ins and fade-outs are applied to their beginnings and ends. You can turn these off, however, for rhythm tracks and other sounds where the attack is important.

1 **TRACK**
 Press

2 Select the track for which you want to change the fade settings.



3 Select FADE and set it to Off if you want to disable it.

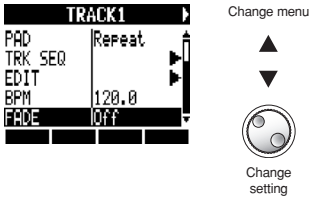

Overview of rhythm functions

With the R24, you can select a pre-installed rhythm pattern that you like and play along. You can also add accents in real-time as you play the pads.

The following settings related to playing the rhythms can be made.

- Change the drum kit and pad sounds
- Set pads to roll (keep playing while pressed)
- Set pad sensitivity

Moreover, you can create original rhythm patterns with the R24.

Play the pads along with a rhythm (click) and input data in real-time or input one note at a time using step input.

The following settings can be made for rhythm patterns.

- Number of bars (when creating a new one)
- Time signature (when creating a new one)
- Volume
- Quantization
- Drum kit stereo positions
- Drum kit sounds

The following operations can be conducted on rhythm patterns.

- Copy pattern
- Delete pattern
- Change the pattern name
- Import a pattern from another project
- Check remaining pattern memory

Playing rhythm patterns

Selecting a rhythm pattern

Select a rhythm pattern and play it.

1 **RHYTHM**
 Press

2 Select the rhythm pattern.

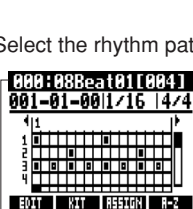



Select pattern

Rhythm pattern name

3 **PLAY**
 Press to play

STOP
 Press to stop

Press and hold  and press  to return to the beginning.

Selecting the drum kit

Select the drum kit sounds.

1 Press  beneath **KIT**.

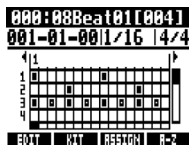

2 Select the drum kit.

KIT SELECT

- BASIC
- STUDIO
- LIVE
- ROCK
- POP

Select kit

 Press

HINT

You can change the pattern order.
 Press the **A-Z** soft key to list the patterns in alphabetical order.
 Press the **№** soft key to list the patterns in numerical order.

NOTE

The drum kit setting is saved with each project.

Playing pad sounds

You can add accents in real-time as you play the pads below the track faders.

1 RHYTHM
 Press

2 Play the pads

1 KICK 10/17	2 SNARE 10/18	3 CLOSED HAT 11/19	4 OPEN HAT 12/20	5 CLASH 13/21	6 SIDE 14/22	7 TOM1 15/23	8 TOM2 16/24
--------------------	---------------------	--------------------------	------------------------	---------------------	--------------------	--------------------	--------------------

Switch banks

You can change the sounds of the pads.

1-8Tr 9-16Tr

Press **1-8Tr** to use the bank of drum kit sounds, and press **9-16Tr** to use the bank of percussion sounds.

Drum rolls (continuous playback)

You can set a pad sound to play at a set interval repeatedly while pressed.

This is convenient when entering hi-hat 16th notes, for example.

1 Press beneath **EDIT**.

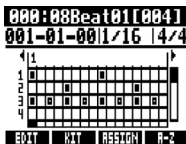

2 Select **PAD ROLL** and set the repeat rate.

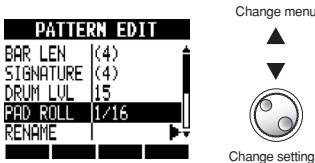

PAD ROLL: repeat interval	
Settings	
2/4-16/4	1/4 notes x 2-16
3/8, 1/3, 1/4, 3/16, 1/6, 1/8, 1/12, 1/16, 1/24, 1/32	Dotted 1/4 notes, 1/2 note triplets, 1/4 notes, dotted 8th notes, 1/4 note triplets, 8th notes, 8th note triplets, 16th notes, 16th note triplets, 32nd notes

3 MASTER REPEAT/STOP Press and hold **REPEAT/STOP**, and press the pad to roll.

If you release **REPEAT/STOP** before the pad, that sound continues rolling after the pad is released. Press the pad again to stop the roll.

Pad sensitivity

Set the pad sensitivity. You can set pads to respond to playing strength or to trigger sounds at a consistent volume regardless of how hard they are played.

1 TOOL
 Press

2 Select **SYSTEM**.

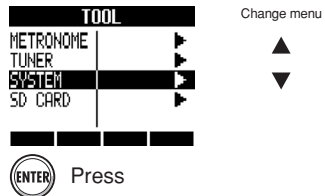

3 Select **PAD SENSE** and set it.

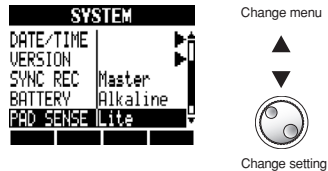

PAD SENSE: pad sensitivity	
Setting	
Soft	Regardless of playing strength, sounds are triggered with a soft volume.
Medium	Regardless of playing strength, sounds are triggered with a medium volume.
Loud	Regardless of playing strength, sounds are triggered with a loud volume.
Lite	Highest sensitivity—even light playing produces loud volume.
Normal	Medium sensitivity.
Hard	Low sensitivity—must play the pads hard to trigger with loud volume.
EX Hard	Lowest sensitivity—must play the pads very hard to trigger with loud volume.

Creating a rhythm pattern

You can create your own original rhythm patterns. After preparing, you can create a rhythm pattern using real-time or step input.

Prepare to create a rhythm pattern

Select an empty rhythm pattern and set the number of bars, time signature and quantization. You can also check the memory remaining for rhythm patterns.

1 RHYTHM
 Press

2 Select an empty rhythm pattern (pattern name is EMPT'Y).

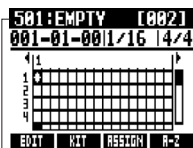

Rhythm pattern name

3 Move to the quantization area and set the value.

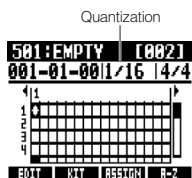

Quantization

Move cursor



Change setting

Quantizations	
Setting	
1/4	Quarter note
1/8	8th note
1/8T	8th note triplet
1/16	16th note
1/16T	16th note triplet
1/32	32nd note
Hi	Tick (1/48 quarter note)

4 Press beneath **EDIT**.

5 Set number of bars and time signature.

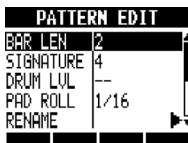

Change menu



Change setting

BAR LEN: Number of bars	
Setting range	
1-99	Number of bars
SIGNATURE: Time signature	
Setting range	
1-8	Number of beats per bar
MEMORY	
Shows current remaining pattern memory	

6 Press

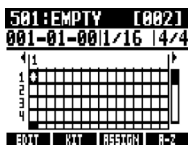

Creating a rhythm pattern

Create a rhythm pattern using real-time input

After preparing, play the pads along with the rhythm (metronome) to create a rhythm pattern with real-time input.

1 Start input.

While pressing and holding ,

press .

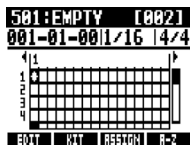

2 Play the pads in time with the rhythm to input data.

501:Pat 501 [002]
001-02-471/16 14/4

Now Recording...

EDIT MIX DELETE ALL DEL

3 Delete input.

Press and hold  under **DELETE** and press a pad. While that pad is being pressed, data that has already been input on that track will be erased.

Press  under **ALL DEL** to erase the data that has already been input on all tracks.

4 End input

STOP
 Press

NOTE

- If your timing is slightly off, it will be corrected in accordance with the quantize setting.
- Depending on the pad sensitivity setting, the force used to play the pads is also recorded as volume changes.
- A metronome pre-count can also be set (Ref. P36).

Create a rhythm pattern using step input

After preparing, you can input notes one at a time (step input) to create a rhythm pattern.

1 Start input.

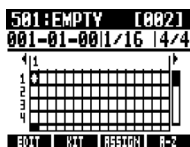

2 Move the cursor to the position where you want to input or delete notes.

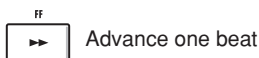
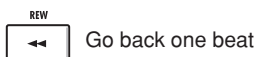

The horizontal axis shows the bars and the vertical access shows the pads by number. One step (one box) is the length of the quantize setting.

3 Play the pads to input notes at the current position. The volume of each note will correspond to the strength it is played (unless sensitivity set otherwise).

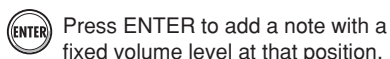

4 Delete a note or change its volume.

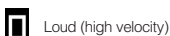
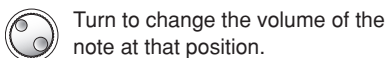

5 End input.



NOTE

- Notes at locations that are between the current quantize settings cannot be deleted. A note at such a position appear as an "X".
- In Step 4, you can also use the dial to input and delete notes.

Copying rhythm patterns

You can copy a rhythm pattern to create a new one based on it, for example.

1 RHYTHM



2 Select the rhythm pattern that you want to copy.

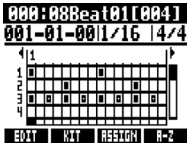
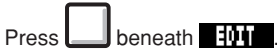

Select pattern

3 Select COPY.



Change menu



4 Select COPY TO.

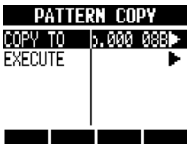

Change menu



5 Select the copy destination.



Select the pattern



6 Select EXECUTE.

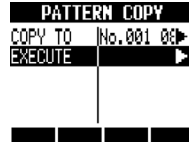

Change menu



HINT

In step 5, you can change the order of the pattern list.

Press the **R-Z** soft key to list the patterns in alphabetical order.

Press the **No.** soft key to list the patterns in numerical order.

Deleting rhythm patterns

You can delete rhythm patterns.

1 **RHYTHM**
 Press

2 Select the rhythm pattern that you want to delete.

Press  beneath **EDIT**.

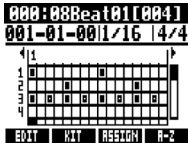

Select pattern

3 Select **DELETE**.



Change menu



Press

4 Select **YES**.



Move cursor



Press

Changing rhythm pattern names

You can change the names of rhythm patterns.

1 **RHYTHM**
 Press

2 Select the rhythm pattern that you want to change the name of.

Press  beneath **EDIT**.

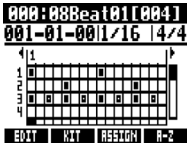

Select pattern

3 Select **RENAME**.



Change menu



 Press

4 Change the name.



Move cursor



Change character

DELETE

Delete character

INSERT





Insert character

 Press

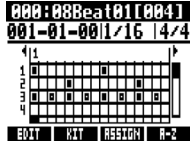

Import rhythm patterns

You can import rhythm patterns from other projects.



You can import all the rhythm patterns (A11) at once or one at a time (Each).

- 1 **RHYTHM**
 Press
- 2 Press  beneath **EDIT**.

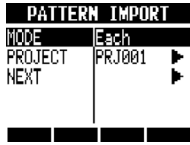
- 3 Select **IMPORT**.

Change menu



 
 Press
- 4 Select **MODE** and set it to A11 or Each.

Change menu





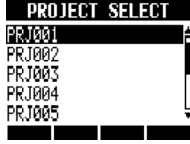

Change setting
- 5 Select **PROJECT**.

Change menu



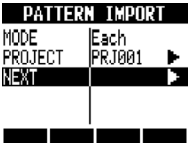

 
 Press
- 6 Select the source project.

Select project





 

 Press

- 7 Select **NEXT**.







Change menu

 
 Press
- 8 Select the rhythm pattern to import (when set to Each).





Select project

 

 Press
- 9 Select the destination rhythm pattern to import (when set to Each).

Select project

 

 Press
- 10 Select **YES**.

Move cursor

 
 Press

NOTE

- Destination rhythm patterns will be overwritten. When set to A11, all the original rhythm patterns in the project will be deleted. When set to Each, the rhythm pattern selected as the destination will be deleted.
- In step 8 or 9, you can change the order of the pattern list.
 Press the A-Z soft key to list the patterns in alphabetical order.
 Press the No. soft key to list the patterns in numerical order.

Setting volume and stereo placement

You can change the volume of a rhythm pattern and the stereo placement of the drum kit.

1 **RHYTHM**
 Press

2 Select the rhythm pattern that you want to make settings for.

Press beneath **EDIT**.

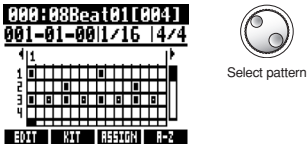

3 Select a menu item and change the setting.

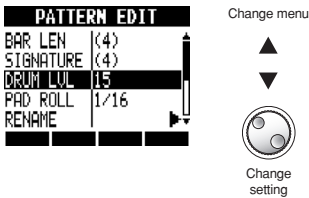

DRUM LVL: Drum volume	
Setting range	
1-15	Drum volume
POSITION: Drum placement	
Setting	
Listener	Drums are placed from left to right as heard from an audience member
Player	Drums are placed from left to right as heard from a drummer

NOTE

POSITION settings are saved for each project.

Assigning rhythm patterns to tracks

The rhythm pattern displayed on the screen can also be assigned to a track.

1 **RHYTHM**
 Press

2 Select the rhythm pattern to assign.



3 While pressing beneath **ASSIGN**, press the pad of the track where you want to assign it.

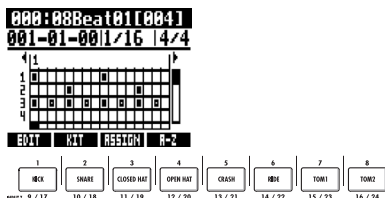

NOTE

- If rhythm patterns are assigned to multiple tracks and played back simultaneously, or patterns with numerous note-on events are played, they might not all play as expected due to the maximum polyphony limitation of the unit.
- When a rhythm pattern is assigned to a track, it cannot be set to loop.
- When you press the **ASSIGN** soft key, the pads of tracks currently set to **New Take** blink.

HINT

- You can also assign rhythm patterns from the **TRACK** menu (Ref. P22).
- In step 2, you can change the order of the pattern list.
 Press the **A-Z** soft key to list the patterns in alphabetical order.
 Press the **No.** soft key to list the patterns in numerical order.

Effect and patch overview

You can select R24 preset patches, and easily apply effects. You can also edit and save patches, making fine adjustments and processing tracks to suit specific songs. Effect and patch operations can only be conducted when the project sample rate is set to 44.1 kHz.

Effect and patch use process

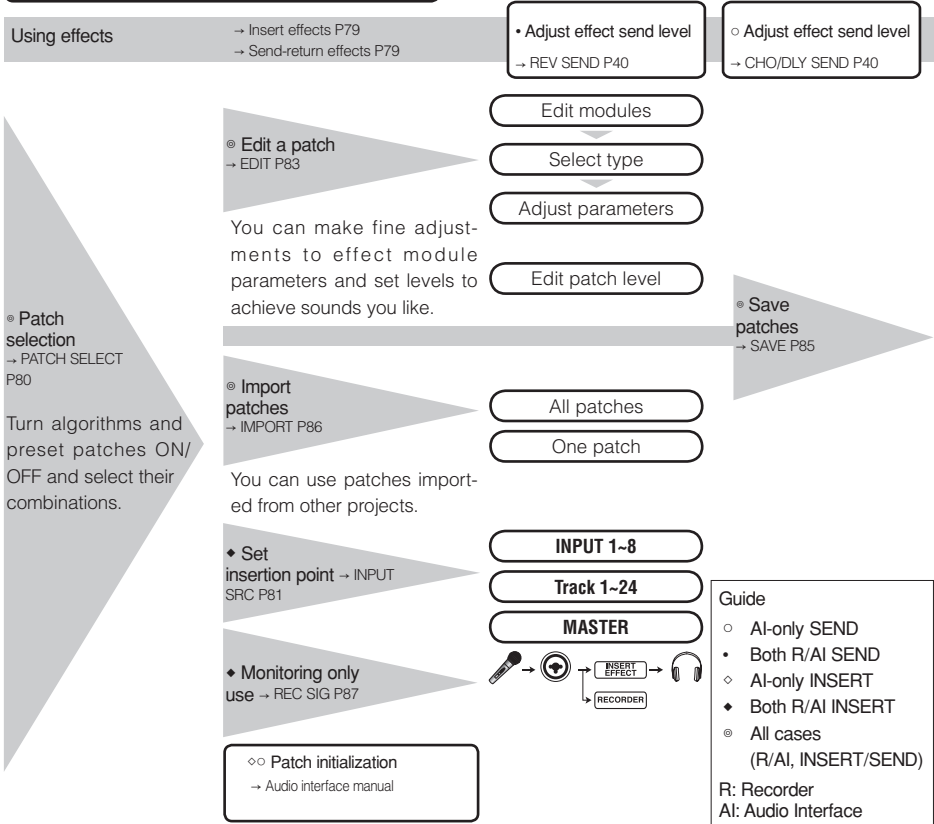

Algorithms and patches

A single effect, which is called an “effect module” (or “module”), consists of two elements—the effect type and its parameters, which control how it processes sound.

A “patch” is the result of adjusting the effect type and parameters of each module. An “algorithm” is an ordered arrangement of patches set to default values prepared for different types of recording and other purposes.

Algorithms

Clean	Distortion
Aco/Bass	Bass

Patches



Module

Effect type

Parameters

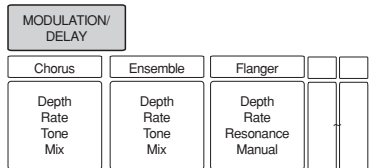

Insert and send-return effects

The insert effects in one project include 330 patches classified into 9 algorithms. You can select algorithms and the patches that they contain to suit your purposes and choose where to insert those patches.

Two types of send/return effects, which are connected internally in the mixer section, can be adjusted using mixer send levels (amount of signal sent to the effect) and can be used together.

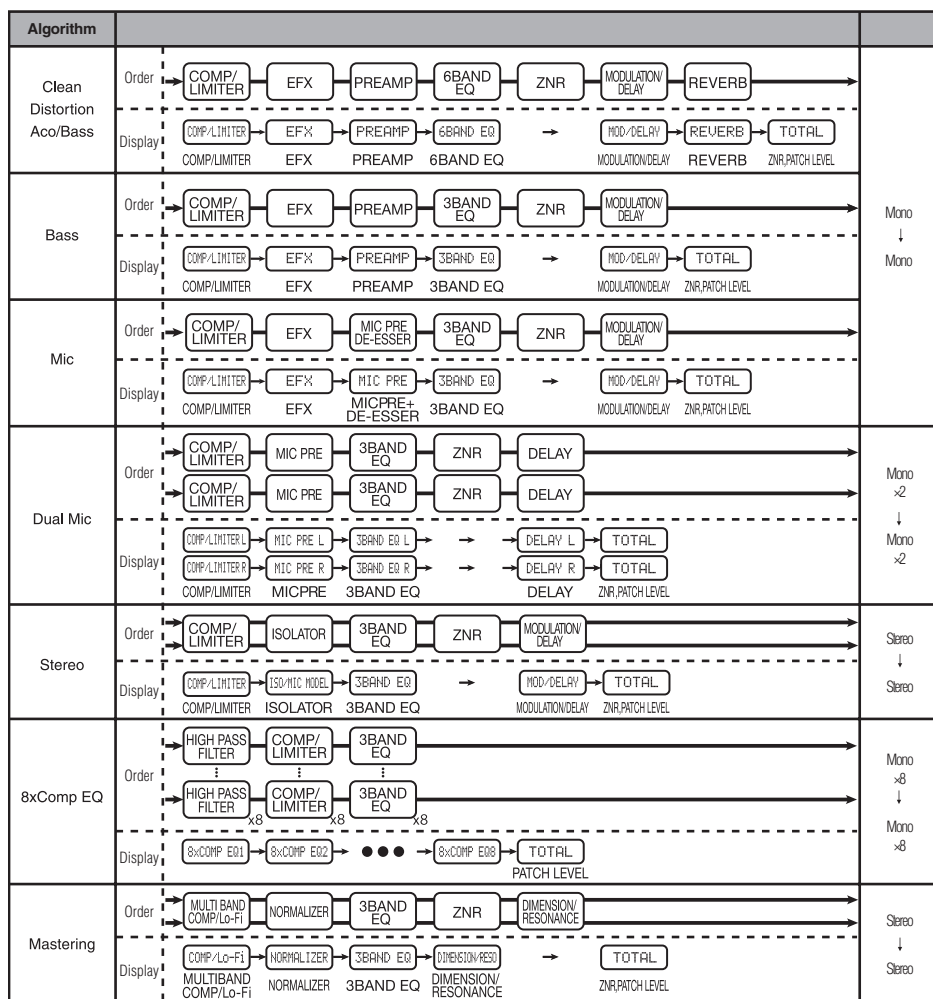

Input and output of insert and send-return effects

The R24's two types of built-in effects—insert effects and send-return effects—can be used at the same time.

Input and output of insert and send-return effects

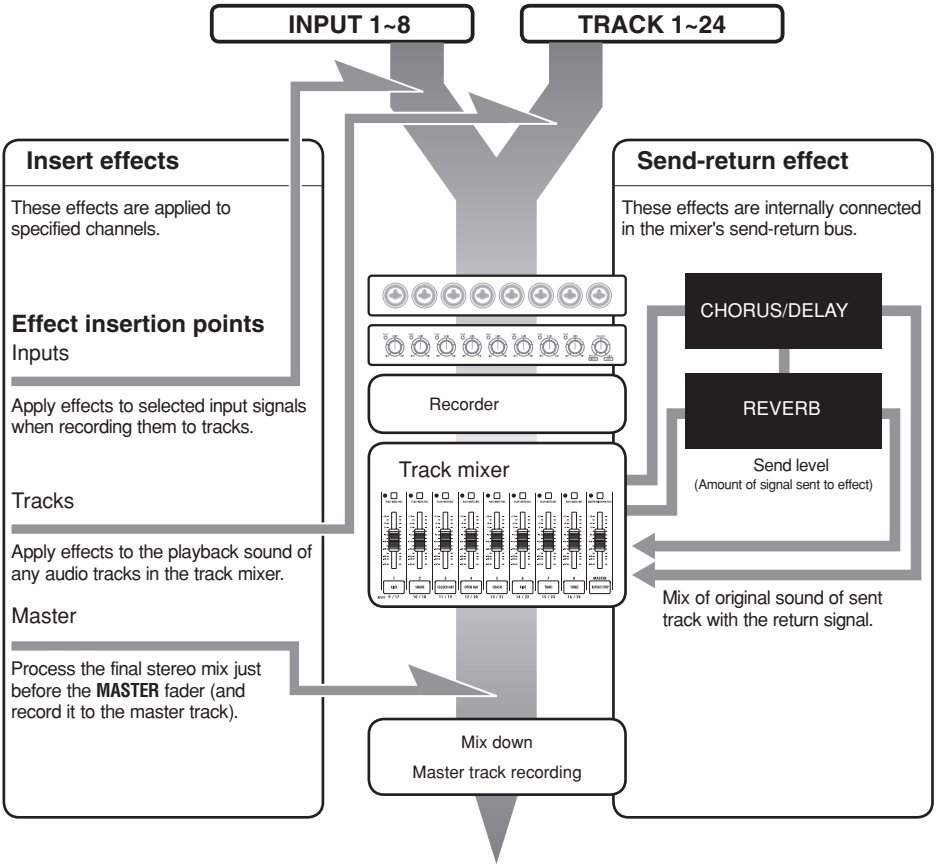

Insert effect signal flow

Insert the effect on a mono input and output in mono.



Send-return effect signal flow

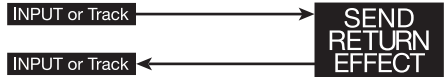

👉 Ref: Effect insertion point P81

Uses of effects and patches

Patches are selected and adjusted the same way for both insert and send-return effects.

Select suitable modules from algorithms, edit patch types and parameters, and save them for use later.

There are some major differences between making settings for the two types of effects. For insert effects, you must select patches and set insertion points. For send-return effects, you must adjust the send level of signals using the mixer.

Other functions include **IMPORT** to bring in patches from other projects and **REC SIG** to apply the effect only to monitoring the playback signal.

The procedures for using effects are the same when using the R24 as a recorder and as an audio interface, but the patches can also be initialized when the unit is used as an audio interface (**INITIAL**).

Insert effects

Algorithm name	Display name	Number of patches (preprogrammed patches)
▼ Clean and crunchy sounds that are suitable for guitars		
Clean/Crunch	Clean	30 (21)
▼ Overdrive and other distorted sounds suitable for guitars		
Distortion	Distortion	50 (45)
▼ Instrument simulation algorithm that is suitable for guitars		
Aco/Bass SIM	Aco/Bass	20 (10)
▼ Algorithm that is suitable for recording bass guitars		
Bass	Bass	30 (20)
▼ Algorithm that is suitable for vocals and other mic recordings		
Mic	Mic	50 (30)
▼ Algorithm for two completely independent mic channels		
Dual Mic	Dual Mic	50 (30)
▼ Algorithm for synths, built-in mics and other stereo recording		
Stereo	Stereo	50 (40)
▼ Algorithm for 8 channels of independent input and output		
8xComp EQ	8xComp EQ	20 (10)
▼ Algorithm for processing final stereo mix signals		
Mastering	Mastering	30 (21)

Send-return effect

Algorithm display name	Number of patches (preprogrammed patches)
REVERB	30 (22)
CHORUS/DELAY	30 (18)

Select effect and patch

Effect

1

EFFECT

Press

Select effect type

Press beneath **INSERT** to select an insert effect.

Press beneath **REVERB** to select a reverb send-return effect.

Press beneath **CHORUS** to select a chorus/delay send-return effect.

2

INSERT EFFECT

ON/OFF On
 ALGORITHM Clean
 PATCH No.00 Z CL
 INPUT SRC Input1
 EDIT
INSERT REVERB CHORUS

Change menu



Change setting

3

INSERT EFFECT

ON/OFF On
 ALGORITHM Clean
 PATCH No.00 Z CL
 INPUT SRC Input1
 EDIT
INSERT REVERB CHORUS

Change menu



Change algorithm

4

INSERT EFFECT

ON/OFF On
 ALGORITHM Clean
 PATCH No.00 Z CL
 INPUT SRC Input1
 EDIT
INSERT REVERB CHORUS

Change menu



Change patch

Setting the insert effect position

You can set the insert effect position.
This menu item only appears for the insert effect.

1 **EFFECT**

Press

Select effect type

Press beneath **INSERT** to select an insert effect.

2 Select ON/OFF and set it to ON.

INSERT EFFECT

ON/OFF | On

ALGORITHM | Clean

PATCH | No.00 Z CL

INPUT SRC | Input1

EDIT

INSERT REVERB CHORUS

Change menu

Change setting

3 Select an algorithm and patch.

INSERT EFFECT

ON/OFF | On

ALGORITHM | Clean

PATCH | No.00 Z CL

INPUT SRC | Input1

EDIT

INSERT REVERB CHORUS

Change menu

Change setting

4 Select INPUT SRC.

INSERT EFFECT

ON/OFF | On

ALGORITHM | Clean

PATCH | No.00 Z CL

INPUT SRC | Input1

EDIT

INSERT REVERB CHORUS

Change menu

5 Select the input source.

INSERT EFFECT

ON/OFF | On

ALGORITHM | Clean

PATCH | No.00 Z CL

INPUT SRC | Track1

EDIT

INSERT REVERB CHORUS

Select input source

Display	Insertion point
Input1-Input8	One input
Track1-Track24	Output of one mono track
Track1/2-Track23/24	Output of a stereo track or two mono tracks
Master	Before MASTER fader
8xCOMP EQ insertion points	
Input1-8	All track 1-8 inputs
Track1-8	All track 1-8 outputs
Track9-16	All track 9-16 outputs
Track17-24	All track 17-24 outputs

NOTE

- You can select a single INPUT (1~8) only if you have chosen the CLEAN, DISTORTION, ACO/BASS SIM, BASS or MIC algorithm.
- You can select Track1-8, Track9-16 or Track17-24 only if you have chosen the 8xCOMP EQ algorithm.
- You can select INPUT 1-8 only when the 8xCOMP EQ algorithm has been chosen.
- After setting the insertion point, if you change the algorithm to 8xCOMP EQ, the insertion point will be changed to Input1-8, Track1-8, Track9-16, Track17-24 (depending on the previously selected setting).
- To insert on a single mono track output, select TRACK1 ~ TRACK24. To insert on two mono tracks or a stereo track, select TRACK1/2 ~ TRACK 23/24. To insert before the **MASTER** fader, select MASTER.

HINT

Changing the insertion point of the effect

By default, the insert effect is inserted on **INPUT 1** in a project. To change this, set the **INPUT SRC** at Step 4.

Setting the insert effect position

Inserting the insert effect on 2 mono inputs
(Dual Mic algorithm)

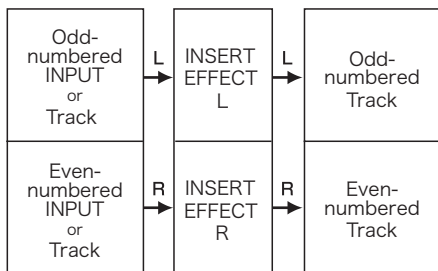

Inserting the insert effect on a stereo input
(Stereo, Mastering algorithms)

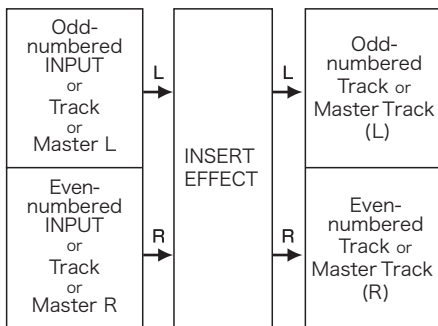

Inserting the insert effect on 8 inputs
(8xComp EQ algorithm)

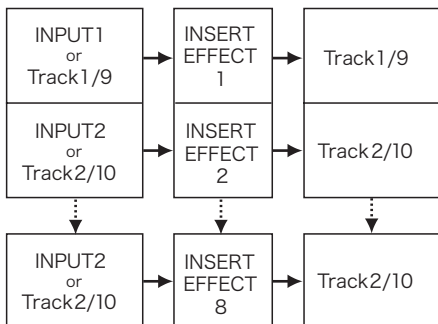

Patch editing (insert and send-return effects)

You can create patches that combine effects together, change effect types in patches, or change processing as you like by adjusting effects using their parameters.

1 **EFFECT**

Press

Select effect type

Press beneath **INSERT** to select an insert effect.

Press beneath **REVERB** to select a reverb send-return effect.

Press beneath **CHORUS** to select a chorus/delay send-return effect.

2 Select ON/OFF and set it to ON.

INSERT EFFECT

ON/OFF	On
ALGORITHM	Clean
PATCH	No.00 Z CL
INPUT SRC	Input1
EDIT	
INSERT	REVERB CHORUS

Change menu

Change setting

3 Select the algorithm/patch.

INSERT EFFECT

ON/OFF	On
ALGORITHM	Clean
PATCH	No.00 Z CL
INPUT SRC	Input1
EDIT	
INSERT	REVERB CHORUS

Change menu

Change setting

4 Select EDIT.

INSERT EFFECT

ON/OFF	On
ALGORITHM	Clean
PATCH	No.00 Z CL
INPUT SRC	Input1
EDIT	
INSERT	REVERB CHORUS

Change menu

ENTER Press

Edit effect modules

5 Select TYPE.

Effect module OFF

COMP/LIMITER

TYPE Off

Press **ENTER** or press the ON/OFF soft key to turn the module on and off.

ON/OFF

ENTER

Effect module ON

COMP/LIMITER

TYPE Compressor

Sense 1

Attack Fast

Tone 8

Level 100

ON/OFF

Effect type

E: Edit mark shown when a patch has been edited or changed

Set the effect module

6 Select the effect module.

COMP/LIMITER

TYPE Compressor

Sense 1

Attack Fast

Tone 8

Level 100

ON/OFF

Change module

MOD/DELAY

TYPE Exciter

Frequency 1

Depth 16

Low Boost 0

ON/OFF

Edit the patch level (final patch sound volume)

7 Select the TOTAL effect module.

Change module

8 Select PATCH LVL and set the value.

Change menu

TOTAL

PATCH LVL 25

ZNR Off

Change value

9 Return to the main effect screen

EXIT Press

Adjust effect parameters

Select a parameter and set it.

```

MOD/DELAY
TYPE Exciter
Frequency 1
Depth 16
Low Boost 0
ON/OFF
  
```

Select parameter



Change value

Change the name (insert effect)

1 Select RENAME.

```

INSERT EFFECT
PATCH No.00 Z CLR
INPUT SRC Input1
EDIT
SAVE
RENAME
ZINERT REVERB CHORUS
  
```

Change menu



Press

2

Change the name.

```

PATCH RENAME
Z CLEAN
[OK] ENTER [CANCEL] EXIT
[DELETE] ZINERT
  
```

Move cursor



Change character



Press

[DELETE]

Delete character

[ZINERT]

Insert character

HINT

- None of the modules in "Empty" patches have been set yet.
- The level of the ZNR module can be adjusted on the TOTAL module screen.
- You can individually edit the modules arranged in the L/R Channels of the DUAL MIC ALGORITHM. The left channel is selected when "L" appears in the effect module name and the right channel is selected when "R" appears.
- Each channel of the 8xCOMP EQ algorithm has its own high pass filter, compressor and EQ that can be independently turned on/off and adjusted. Check the current channel by looking at the number shown at the end of the effect module name.

NOTE

- You cannot edit an algorithm itself, including the combination and arrangement of its effect modules.
- When you turn an effect module OFF, all its settings, including the type and parameters are disabled.
- When using the 8xCOMP EQ effect, you cannot turn it ON/OFF for all channels at once. You must set it for each channel separately.
- You cannot turn off TOTAL modules.
- The 8xCOMP EQ algorithm does not include a ZNR module.
- If you switch to another patch without saving a patch that has been edited (showing the 'E' mark), changes will be lost. Please refer to the next page for how to save patches.

Patch saving (insert and send-return effects)

Once you have edited a patch, always save it if you want to keep the changes. You can save a patch at any patch number within the same algorithm.

1 **EFFECT**

Press

Select effect type

Press beneath **TWEED** to select an insert effect.

Press beneath **REVERB** to select a reverb send-return effect.

Press beneath **CHORUS** to select a chorus/delay send-return effect.

2 Select the algorithm/patch.

INSERT EFFECT

ON/OFF On

ALGORITHM Clean

PATCH No.00 Z CL

INPUT SRC Input1

EDIT

TWEED REVERB CHORUS

Change menu

▲

▼



Change setting

3 Select **SAVE**.

INSERT EFFECT

ALGORITHM Clean

PATCH No.00 Z CL

INPUT SRC Input1

EDIT

SAVE

TWEED REVERB CHORUS

Change menu

▲

▼

 Press

4 Select **SAVE TO**.

EFFECT PATCH SAVE

SAVE TO No.00 Z CL

EXECUTE

Change menu

▲

▼

 Press

5 Select where you want to save it.

PATCH SAVE TO

No.00:Z CLEAN

No.01:Z CHORUS

No.02:FdClean

No.03:UxCrunch

No.04:TWEED

Patch number:
patch name
where you
want to save it



Set save location

 Press

Continued on the next page

6 Select **EXECUTE**.

EFFECT PATCH SAVE

SAVE TO No.00:Z CL

EXECUTE

 Press

NOTE

- These procedures are the same for both insert and send-return effects.
- If you switch to another patch without saving a patch that has been edited (showing the 'E' mark), changes will be lost. Always save patches.
- The import source and the import destination are different projects when using **PATCH IMPORT**.

HINT

You can save your edited patch to any patch number within the same algorithm. By doing this, you can also make a patch copy by saving an existing patch to a different number.

Patch importing (insert and send-return effects)

You can import one or all patches that have been created in another project for use in the current project.

3 Select **IMPORT**.

4 Select **MODE** and set it to **All** or **Each**.

All	Import all patches from the source project
Each	Select and import one patch from the source

Import all patches

IMPORT>All

1 Select **PROJECT**.

2 Select the project to import from.

3 Select **NEXT**.

4 Select **YES**.

Import one patch

IMPORT>Each

1 Select **PROJECT**.

2 Select the project to import from.

3 Select **NEXT**.

4 Select the patch to import.

5 Select the destination patch.

6 Select **YES**.

Using the insert effect only for monitoring

By applying an insert effect only to monitoring, input signals can be recorded unprocessed to tracks.

1 **EFFECT**
 Press
 Select effect type
 Press beneath **INSERT** to select an insert effect.

2 Select algorithm/patch.
INSERT EFFECT
 ON/OFF On
 ALGORITHM Clean
 PATCH No.00 Z CL
 INPUT SRC Input.1
 EDIT
 INSERT REVERB CHORUS
 Change menu
 Change setting

3 Select REC SIG and set it.
INSERT EFFECT
 EDIT
 SAVE
 RENAME
 IMPORT
 REC SIG Wet
 INSERT REVERB CHORUS
 Change menu
 Change setting

Wet	Input signals are recorded to tracks after being processed by the insert effect. (Default value)
Dry	Input signals are recorded to tracks before being processed by the insert effect. The input signal monitored from the OUTPUT and PHONES jacks, however, is processed by the insert effect first.

Using the insert effect only for monitoring

By default, when an insert effect is applied to an input signal, the signal with the effect is recorded to the track.

However, if necessary, you can apply the insert effect only to monitoring and record the unprocessed input signals to the tracks.

For example, you can record vocals without an effect, but apply an insert effect to a microphone signal to make singing easier for a vocalist.

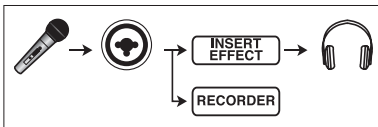

HINT

- The settings made here are stored for each project separately.
- If necessary, reset to **Wet** before recording other parts.

Project overview & project protection

A project stores data and settings necessary for music playback.

The “PROTECT” function allows you to prevent the alteration of a completed project.

All elements of a piece of music, including audio files, information about track assignments, and mixer, effect, metronome and tuner settings are stored in a project as one unit.

A maximum of 1000 projects can be stored on a single card. Create a new project for each new piece of music.

DATA saved in a project:

- Audio data for every track including the MASTER track
- Mixer settings
- Patch numbers and settings made for insert and send-return effects
- Contents of play lists
- Other necessary files
- Sampler loop and sequence data settings
- Rhythm pattern, volume and stereo placement settings

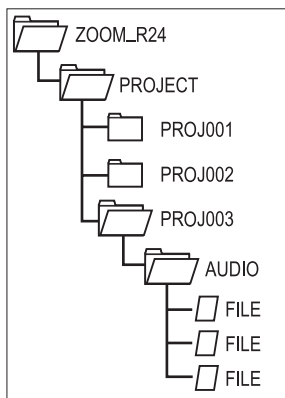

The names of the folders in the PROJECT folder correspond to the projects with the same names.

Protecting a project PROJECT>PROTECT

1 **PROJECT**
 Press

2 Select PROTECT.

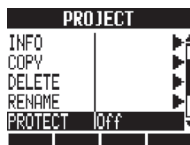

Change menu



3 Select ON.

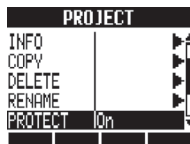

Change

NOTE

- When a project is protected, you cannot record in it or edit it, and any changes will not be saved to the SD card. Set “PROTECT” to “Off” if you want to record in it or edit it again.
- Projects that are not protected will be automatically saved to the SD card when you turn the **POWER** switch OFF or when you open another project.
- We recommend setting “PROTECT” to “On” once you complete a piece of music to avoid saving unwanted changes mistakenly later.

HINT



This icon appears when a project is protected.







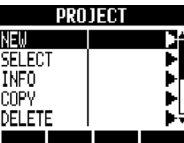

Creating a new project



With the R24 you can create up to 1000 projects on a single card.
 You can also transfer the settings of the previous project to a new project.



1 PROJECT
 Press



2 Select NEW.
 Change menu
 Press

3 Select NAME.
 Change menu
 Press

4 Change the project name as necessary.
 Move cursor
 Delete character
 Insert character
 Press

5 Set whether to use the settings from the last project.
 Change menu
 Change setting

6 Set the sample rate.
 Change menu
 Change setting

7 Select EXECUTE.
 Change menu
 Press

NOTE

- You can use the settings and values of the last project in the new one.

Settings carried over with Continue
<ul style="list-style-type: none"> • BIT LENGTH settings • INSERT EFFECT settings • Send-return EFFECT settings • Track status (PLAY/MUTE/REC) settings • BOUNCE settings • Track parameters settings • METRONOME settings
Reset
Default settings are used for each item

- The RATE can also be set to a sampling rate that is suitable for DVD audio.

RATE: sampling rate	
Setting	
44.1kHz	Standard (default value)
48.0kHz	For DVD sound, etc.

- When set to 48 kHz, effects cannot be used.

Selecting projects and files

You can select a project to use for recording, playback and editing from the Top Screen. You can also select files for playback, copying, deletion and other operations.

Select a project PROJECT>SELECT

- 1** **PROJECT** Press

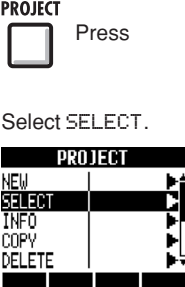

The screen displays the PROJECT menu with options: NEW, SELECT, INFO, COPY, DELETE. A vertical cursor is positioned on the SELECT option. To the right of the screen is a double-headed vertical arrow icon labeled "Change menu".
- 2** Select **SELECT**.

(ENTER) Press
- 3** Select the project.

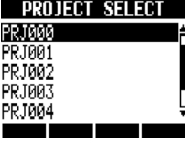

The screen displays the PROJECT SELECT menu with options: PRJ000, PRJ001, PRJ002, PRJ003, PRJ004. A vertical cursor is positioned on the PRJ000 option. To the right of the screen is a circular icon with a double-headed arrow labeled "Change project".

(ENTER) Press

NOTE

You can only playback and record to the project that is currently loaded. You cannot use multiple projects at the same time.

HINT

When the R24 power is turned ON, the project loaded the last time the unit was used will be loaded automatically.

Select a file PROJECT>FILE

- 1** **PROJECT** Press



The screen displays the PROJECT menu with options: COPY, DELETE, RENAME, PROTECT, FILE. The PROTECT option is set to "Off". A vertical cursor is positioned on the FILE option. To the right of the screen is a double-headed vertical arrow icon labeled "Change menu".
- 2** Select **FILE**.

(ENTER) Press
- 3** Select the file.

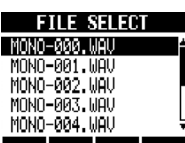



The screen displays the FILE SELECT menu with options: MONO-000.WAV, MONO-001.WAV, MONO-002.WAV, MONO-003.WAV, MONO-004.WAV. A vertical cursor is positioned on the MONO-000.WAV option. To the right of the screen is a circular icon with a double-headed arrow labeled "Select file".

(ENTER) Press

Asterisks (*) appear to the left of names of files that are already assigned to tracks.

You can use the following keys if you want to listen to a file for confirmation.

PLAY 	Press the PLAY key to start playback.
STOP 	Press the STOP key to stop playback.

Project and file information

You can display information about the currently loaded project, file names, creation dates, sizes, recording times and other information.

Project information

PROJECT>INFO

Follow these procedures after opening the project which has the information that you want to see.

1 **PROJECT**
 Press

2 Select INFO.

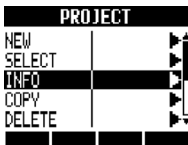

Change menu

Press

3 Check the information.

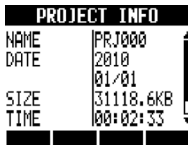

Scroll

PROJECT INFO: project information	
NAME	Project name
DATE	Year/month/date of creation
SIZE	Capacity used
TIME	Recording time
RATE	Sample rate

HINT

On the PROJECT INFO screen, project and file information can only be viewed. Their contents cannot be changed directly.

File information

PROJECT>FILE>INFO

1 **PROJECT**
 Press

2 Select FILE.

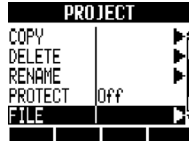

Change menu

Press

3 Select the file.

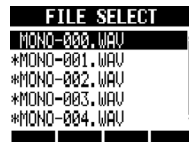

Change file

Press

4 Select INFO.



Change menu

Press

5 Check the information.

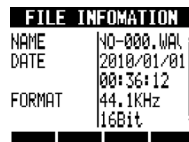

Scroll

FILE INFORMATION: file information	
NAME	File name
DATE	Year/month/date/time of creation
FORMAT	Sampling frequency and bit rate
SIZE	Capacity used
TIME	Recording time









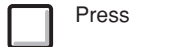
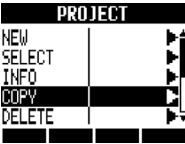

Copying projects and files

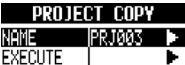
You can copy a saved project and use it as a new project.

Within the same project, you can change the names of files and make copies of them.

Copy a project PROJECT>COPY

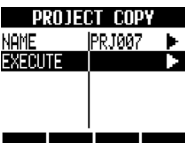









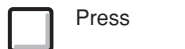
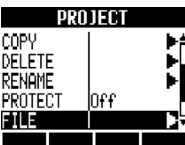

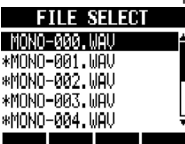

Follow these procedures after opening the project that you want to copy.

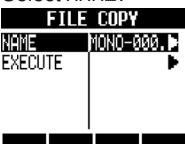
- 1 **PROJECT**
 Press
- 2 Select **COPY**.
 Change menu
 Press
- 3 Select **NAME**.
 Change menu
 Press
- 4 Change the project name.
 Move cursor
 Delete character
 Insert character
 Press
- 5 Select **EXECUTE**.
  Press

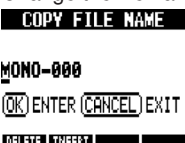
NOTE

You cannot copy a project without changing the name to something different from the original.

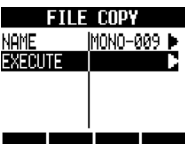
Copy a file PROJECT>FILE>COPY

- 1 **PROJECT**
 Press
- 2 Select **FILE**.
 Change menu
 Press
- 3 Select the file to copy.
 Change file
 Press
- 4 Select **COPY**.
 Change menu
 Press
- 5 Select **NAME**.
 Change menu
 Press
- 6 Change the file name.
 Move cursor
 Delete character
 Insert character
 Press
- 7 Select **EXECUTE**.
  Press

Changing project and file names

You can change the names of the currently loaded project and files.

Changing a project name PROJECT>RENAME

Open the project that you want to change the name of and follow these procedures.

- PROJECT**
Press

- Select **RENAME**.



Change menu



(ENTER) Press
- Change the characters.

NEW PROJECT NAME

PRJ003

(OK) **ENTER** **(CANCEL)** **EXIT**

DELETE **INSERT**

(ENTER) Press

Move cursor  **DELETE** Delete character

 Change character **INSERT** Insert character

NOTE

- You cannot change the name to the same name as that of an existing project.
- The name of each project folder in the ZOOM_R24/PROJECT folder on the SD card is the same as the name of the corresponding project.

HINT

Project names

Max. number of characters: 8

Alphabet: A-Z (upper case)

Symbols: _ (underscore)

Numerals: 0-9

File names

Max. number of characters: 219 (not incl. extension)

Alphabet: A-Z, a-z

Symbols: (space) ! # \$ % & \ () + , - ; = @
[] ^ _ ` { } ~

Numerals: 0-9

Changing a file name PROJECT>FILE>RENAME

- PROJECT**
Press



- Select **FILE**.



Change menu

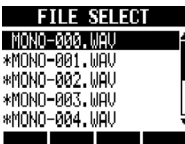

(ENTER) Press
- Select the file name.



Change file



(ENTER) Press
- Select **RENAME**.



Change menu



(ENTER) Press
- Change the characters.

FILE RENAME

MONO-000

(OK) **ENTER** **(CANCEL)** **EXIT**

DELETE **INSERT**

(ENTER) Press

Move cursor  **DELETE** Delete character

 Change character **INSERT** Insert character

Deleting projects and files

Delete selected projects and files.

Delete a project

PROJECT>DELETE

- 1** **PROJECT**

 Press
- 2** Select DELETE.

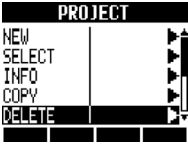
 Change menu

 Press
- 3** Select the project to delete.

 Change project

 Press
- 4** Select YES.

 Move cursor

 Press

NOTE

- Once a project or file is deleted, it cannot be recovered. Please delete with care.
- If PROTECT is On for a project, that project and its files cannot be deleted.

Delete a file

PROJECT>FILE>DELETE

- 1** **PROJECT**

 Press
- 2** Select FILE.

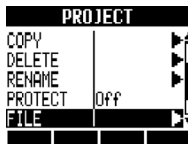
 Change menu

 Press
- 3** Select the file name.

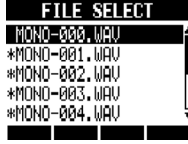
 Change file

 Press
- 4** Select DELETE.

 Change menu

 Press
- 5** Select YES.

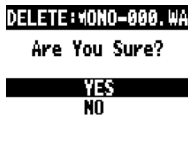

 Move cursor

 Press





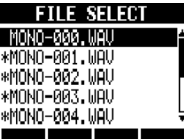
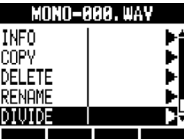

Dividing files

You can divide a file at any point to make two files.

Do this to delete unnecessary portions of recordings or to divide long recordings.

- 1 **PROJECT**
 Press
- 2 Select **FILE**.

Change menu
 Press
- 3 Select the file.

Select file
 Press
- 4 Select **DIVIDE**.

Change menu
 Press
- 5 Set the division point.

Change value
Change time unit
- 6 Press beneath **EVEC**.
- 7 Select **YES**.

Move cursor
 Press

You can use the following keys to listen to a file and to set the division point.

PLAY 	Press to start playback
STOP 	Press to stop playback
FF 	Press to fast forward
REW 	Press to rewind
	Press together to return to the beginning of the file
	Use the mark keys to move to marks

HINT

- When a file is divided, files with new names will be created automatically in the same folder. "A" is added to the end of the name of the file of the part before the dividing point. "B" is added to the end of the name of the file of the part after the dividing point.
- The original divided file is deleted.



Ref: Using the counter and marks to locate

P33

Sequential playback of projects

The playback order of multiple projects can be registered and managed in playlists. Use these to play songs consecutively, for live performance accompaniment and when outputting to an external recorder, for example.

Playback a playlist

- PROJECT**

Press 
- Select SEQ PLAY.

PROJECT

RENAME
PROTECT Off
FILE
REC
SEQ PLAY

Change menu 

 Press
- Select the playlist.

SEQUENCE PLAY LIST

List1:2Songs
List2:1Song
List3:2Songs
List4:Empty
List5:Empty

Number of projects in list  Select list
'Empty' shown when no songs in list

Playlist number  Press
- Select PLAY.

List1:2Songs

EDIT
DELETE
PLAY

Change menu 

 Press

Screen appearance during playback

List1 — Playlist number

TR001:PRJ002 — Project name





0:00:06:708 — Elapsed playback time

Playback track number 

Playback stops at the end of the last project.

HINT

Key operation during playback

	Play from the beginning of the current project
	Stop playback and return to the beginning of the current project
	Play from the beginning of the first project (TR001)
	Stop playback and start playback from the beginning of the next project
	Stop playback and start playback from the beginning of the previous project

Edit a playlist

PROJECT>SEQ PLAY>EDIT

- Select EDIT.

List4:Empty

EDIT
DELETE
PLAY

Change menu 

 Press
- Register projects, edit and change playlists
- Select the first project (or the project to change).

EDIT>List4

1 End of List

Change tracks 

End of list indication

DELETE | INSERT
- Register project to be played.

EDIT>List4

1 PRJ002
2 End of List

Change project 

Change project

DELETE | INSERT
- Select and register more projects.

EDIT>List4

1 PRJ002
2 End of List

Change tracks 

Change tracks

DELETE | INSERT
- EDIT>List4**

1 PRJ002
2 PRJ001
3 End of List

Change project 

Change project

DELETE | INSERT
-  Press to return.

Remove a project from a list

5

Select a project to remove.

```
EDIT>List4
1 PRJ002
2 PRJ001
3 End of List
```

Change tracks



```
DELETE INBERT
```

6

Press  beneath **DELETE**.

```
EDIT>List4
1 PRJ002
2 End of List
```

```
DELETE INBERT
```

Insert a project into a list

5

Select the track number to insert to.

```
EDIT>List4
1 PRJ002
2 End of List
```

Change tracks



```
DELETE INBERT
```

6

Press  beneath **INSERT**.

```
EDIT>List4
1 PRJ002
2 PRJ002
3 End of List
```

This inserts the current project. Use the dial to change to a different project.

```
DELETE INBERT
```



Change project

Delete a playlist

PROJECT>SEQ PLAY>DELETE

4

Select **DELETE**.

```
List4:2Songs
EDIT
DELETE
PLAY
```

Change menu



 Press

5

Select **YES**.

```
DELETE>List4
Are You Sure?
YES
NO
```

Move cursor



 Press

NOTE

- If a master track or the file assigned to the master track is deleted, the playlist will become empty.
- Set the master track to the recording that you want to hear when you register a project in a playlist.
- To change the file of a registered project, set its master track and edit the playlist.
- The maximum number of playlists is 10. Each playlist can have a maximum of 99 registered projects.
- A project cannot be registered if its master track is not set or its file is less than 4 seconds.

 Ref: Master track settings



P46

Recording settings

The R24 can record at 24-bit, which is higher quality than the 16-bit format used for audio CDs. When recording, the unit can overwrite previous recordings or save them and create new ones. This is useful for bands and drums and when you want to record multiple takes.

Setting/changing the bit rate

PROJECT>REC>BIT LEN

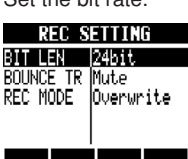
- 1 **PROJECT**
 Press
- 2 Select REC.

- 3 Select BIT LEN.

- 4 Set the bit rate.

HINT

- When overwriting, recording will be at the bit rate of the original file. For example, you cannot overwrite a file recorded at 16-bit with a 24-bit file.
- Settings are stored separately for each project.
- The default value is 16bit.
- If you use 44.1kHz/24bit, 48kHz/16bit or 48kHz/24bit formats, you will have to convert files to 44.1kHz/16bit to create an audio CD.

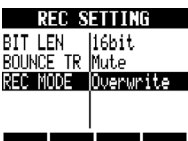
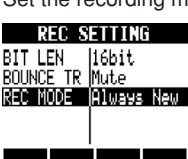
Setting/changing recording mode

PROJECT>REC>REC MODE

- 1 **PROJECT**
 Press
- 2 Select REC.

- 3 Select REC MODE.

- 4 Set the recording mode.

REC MODE: recording mode	
Setting	
Overwrite	Previous recordings overwritten (default value)
Always New	Previous recordings saved and new recordings always made





NOTE

See "Bounce destination track settings" for use of the BOUNCE TR item (Ref. P43).

Adjusting the display

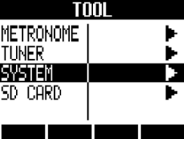



You can adjust the backlight and contrast of the display.

Turning the backlight ON/OFF TOOL>SYSTEM>LIGHT

- 1 **TOOL**
 Press
- 2 Select **SYSTEM**.
 Change menu
 Press
- 3 Select **LIGHT**.
 Change menu
- 4 Set the value.
 Change value

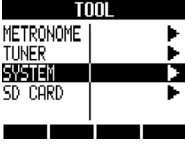
On	Backlight lit (default value)
Off	Backlight unlit
15sec	Backlight darkens if the unit is not used for 15 seconds
30sec	Backlight darkens if the unit is not used for 30 seconds

Adjusting the contrast TOOL>SYSTEM>CONTRAST

- 1 **TOOL**
 Press
- 2 Select **SYSTEM**.
 Change menu
 Press
- 3 Select **CONTRAST**.
 Change menu
- 4 Set the value.
 Change value

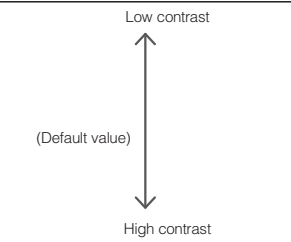
1	
2	
3	
4	
5	
6	
7	
8	







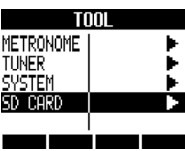

HINT

Turn the backlight off to conserve batteries.

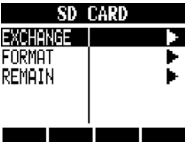
Changing the SD card while the power is on

You can change the SD card while the power is on. Do this if the remaining capacity of the inserted card is low or if you need to import previously recorded data from the SD card.



Changing the SD card while the power is on

- 1 **TOOL**
 Press
- 2 Select SD CARD.

Change menu

 Press
- 3 Select EXCHANGE.

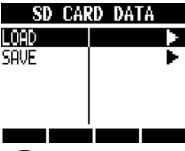
Change menu

 Press

Card replacement possible
- 4 Remove the SD card

- 5 Insert an SD card







NOTE

- If the inserted SD card is already formatted for the R24, proceed to Step 6 of "Load data from the new SD card" or "Save R24 data to the new SD card".
- If you insert an SD card that has not been formatted for use with the R24, follow the procedures for formatting an SD card on the next page.

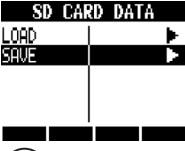
Load data from the new SD card

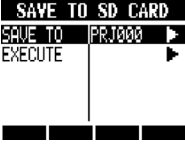
- 6 Select LOAD.

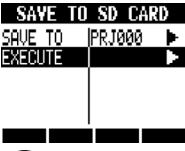
Change menu

 Press

Save R24 data to the new SD card

- 6 Select SAVE.

Change menu

 Press
- 7 Select SAVE TO and set the project where you want to save it

Change menu

Change setting
- 8 Select EXECUTE.

 Press

NOTE

- Disable write-protection on an SD card before inserting it.
- SAVE includes various data for the project in use, but no audio data is saved.

Formatting SD cards/Checking card capacities

You can format an SD card for use with the R24, delete all the data on it, and check its capacity (remaining space).

Format SD card/delete all data TOOL>SD CARD>FORMAT

- 1 **TOOL**
 Press
- 2 Select SD CARD.

TOOL	
METRONOME	▶▶▶
TUNER	▶▶▶
SYSTEM	▶▶▶
SD CARD	▶▶▶

Change menu
▲▼

(ENTER) Press
- 3 Select FORMAT.

SD CARD	
EXCHANGE	▶▶▶
FORMAT	▶▶▶
REMAIN	▶▶▶

Change menu
▲▼

(ENTER) Press
- 4 Select YES.

SD CARD FORMAT	
Are You Sure?	
YES	▶▶▶
NO	▶▶▶

Move cursor
▲▼

(ENTER) Press

Check SD card remaining capacity TOOL>SD CARD>REMAIN

- 1 **TOOL**
 Press
- 2 Select SD CARD.

TOOL	
METRONOME	▶▶▶
TUNER	▶▶▶
SYSTEM	▶▶▶
SD CARD	▶▶▶

Change menu
▲▼

(ENTER) Press
- 3 Select REMAIN.

SD CARD	
EXCHANGE	▶▶▶
FORMAT	▶▶▶
REMAIN	▶▶▶

Change menu
▲▼

(ENTER) Press

CARD REMAIN		
0%	50%	100%
<div style="border: 1px solid black; width: 100%; height: 10px; position: relative;"> <div style="width: 80%; background-color: #ccc; position: absolute;"></div> </div>		
865MB		
2:51:33		

Card open space
 Remaining recording time
 for the current recording
 format

NOTE

- If you format an SD card, all its data will be permanently erased.
- When you format an SD card, all the data on the card is deleted and folders and files that are exclusively for R24 use will be created.
- If the remaining capacity of the SD card is less than the amount of the data being recorded, recording will fail. Change the card before you run out of space.

Checking the system version/Setting the battery type

You can check the current version of the system software.

Set the battery type to make display of the remaining battery charge more accurate.

Checking the system version TOOL>SYSTEM>VERSION

1 **TOOL**
 Press

2 Select SYSTEM.

TOOL

METRONOME	▶▶▶▶▶
TUNER	▶▶▶▶▶
SYSTEM	▶▶▶▶▶
SD CARD	▶▶▶▶▶

Change menu
▲▼

(ENTER) Press

3 Select VERSION.

SYSTEM

LIGHT	0n	▶▶▶▶▶
CONTRAST	8	▶▶▶▶▶
DATE/TIME		▶▶▶▶▶
VERSION		▶▶▶▶▶
SYNC REC	Master	▶▶▶▶▶

Change menu
▲▼

(ENTER) Press

4 Check the information.

SOFTWARE VERSION

SYSTEM	1.00
SUB SYS	1.00
BOOT	1.00

Setting the battery type TOOL>SYSTEM>BATTERY

1 **TOOL**
 Press

2 Select SYSTEM.

TOOL

METRONOME	▶▶▶▶▶
TUNER	▶▶▶▶▶
SYSTEM	▶▶▶▶▶
SD CARD	▶▶▶▶▶

Change menu
▲▼

(ENTER) Press

3 Select BATTERY.

SYSTEM

CONTRAST	8	▶▶▶▶▶
DATE/TIME		▶▶▶▶▶
VERSION		▶▶▶▶▶
SYNC REC	Master	▶▶▶▶▶
BATTERY	Alkaline	▶▶▶▶▶

Change menu
▲▼

4 Set the battery type.

SYSTEM

CONTRAST	8	▶▶▶▶▶
DATE/TIME		▶▶▶▶▶
VERSION		▶▶▶▶▶
SYNC REC	Master	▶▶▶▶▶
BATTERY	Ni-MH	▶▶▶▶▶

Change type

Alkaline	Alkaline batteries (default value)
Ni-MH	Nickel-metal hydride batteries

HINT

Check for the latest system software at the ZOOM website (<http://www.zoom.co.jp>).

NOTE

Use only alkaline or nickel-metal hydride batteries.

Phantom power settings

Set the **PHANTOM** switch to **ON** to supply phantom power to **INPUTS 3-8**.

To conserve batteries, you can turn it off for input pairs 3/4 and 7/8 and reduce the voltage to 24 V.

Setting phantom power TOOL>SYSTEM>PHANTOM

1 **TOOL**
 Press

2 Select **SYSTEM**.

TOOL	
METRONOME	▶
TUNER	▶
SYSTEM	▶
SD CARD	▶

Change menu

 Press

3 Select **PHANTOM**.

SYSTEM	
VERSION	▶
SYNC REC	Master
BATTERY	Alkaline
PAD SENSE	Lite
PHANTOM	▶

Change menu

 Press

4 Select **VOLTAGE** and set the value.

PHANTOM	
VOLTAGE	24V
3/4ch	Off
7/8ch	Off

Change menu





Change setting

5 Select **3/4ch** or **7/8ch** and set it to **On** or **Off**.

PHANTOM	
VOLTAGE	24V
3/4ch	On
7/8ch	Off

Change menu



Change setting

NOTE

- The phantom power for inputs 5 and 6 cannot be turned off separately. They will be supplied with phantom power unless the **PHANTOM** switch is set to **OFF**.
- Do NOT supply phantom power to microphones and instruments that do not need it. Doing so could cause damage. Check the instructions for the microphone that you are using before supplying phantom power.

Connecting with a computer

Use USB to connect an R24 to a computer (Windows or Macintosh OS).

By connecting this unit to a computer, you can use it as an SD card reader, an audio interface for sound input and output and a control surface to control DAW software

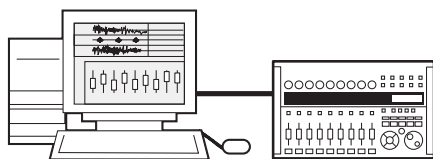

NOTE

- To import an audio file into the R16, its format must be WAV with a sampling rate of 44.1/48 kHz and a bit rate of 16 or 24.
- To use WAV files in a project, they must use the sampling rate as set for the project when it was created (RATE).
- File name can have up to 219 characters (not including the extension). The following characters are allowed
 Alphabet: A-Z, a-z
 Numerals: 0-9
 Symbols: (space) ! # \$ % & \ () + , - ; = @
 [] ^ _ ` { } ~
- You can connect an R24 when its power is ON with a computer by USB. If you connect the R24 by USB when its power is OFF, you can start it up with power supplied over USB.
- When using the R24 as a card reader or as an audio interface, it cannot be used as a recorder at the same time.

HINT

- Card reader OS compatibility
 Windows: Windows XP and later
 Macintosh: Mac OS x 10.2 and later
- Project data is saved to the corresponding PROJECT folder in the ZOOM_R24 folder on the SD card as. Folders are created and managed for each project.
- Audio data is saved as WAV files inside the AUDIO folder of its project folder.
- The "PRJINFO.TXT" file inside each AUDIO folder shows the names of files assigned to tracks.
- MASTER tracks and stereo tracks are stereo WAV files.

Card reader

You can access the R24 SD card using a computer to backup, read and import various data, projects and files.

Using the unit as an SD card reader

1 Connect the R24 with a computer by USB (DEVICE port)

2 **USB**
 Press

3 Select READER.

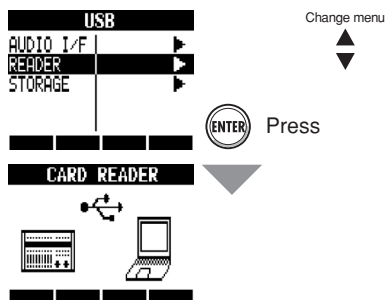

Operating the R24 from a computer

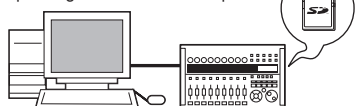

To computer ←

Back up project data on an SD card to a computer.

From computer →

Import audio data and computer backups to the SD card.

HINT

- To import WAV files from a computer, copy them to the "AUDIO" folder in the project folder where you want to use them. Use the R24 to assign the files to tracks.

Disconnecting

1 Eject the R24 volume icon from your computer to end the connection.

2 EXIT or **USB** Press to disconnect the R24

3 Select YES.



Using USB memory to save and import data

By connecting USB memory directly to the R24, you can save and import files. This is convenient for exchanging files with band members. When using USB memory with the unit for the first time, you must create a folder especially for the R24 on that USB memory.

Saving files to USB memory

USB>STORAGE>FILE SAVE

- 1 Connect the USB memory to the R24 USB HOST port.

- 2 **USB**
 Press

- 3 Select STORAGE.



- 4 Select FILE SAVE.

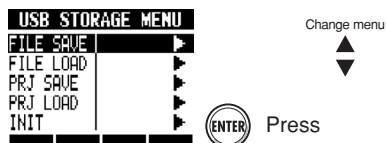

- 5 Select the project with the file to save.

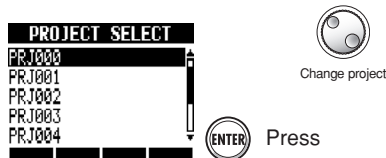

- 6 Select the file.

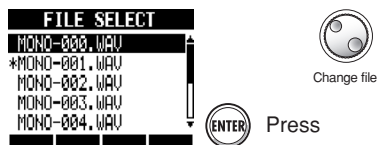

- 7 Change the file name as necessary.

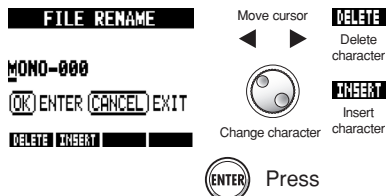

- 8 Select YES

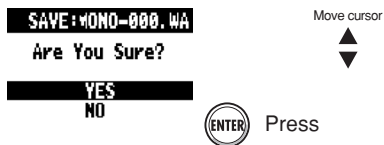

Loading files from USB memory

USB>STORAGE>FILE LOAD

- 1 Connect the USB memory to the R24 USB HOST port.

- 2 **USB**
 Press

- 3 Select STORAGE.



- 4 Select FILE LOAD.



- 5 Select the folder.

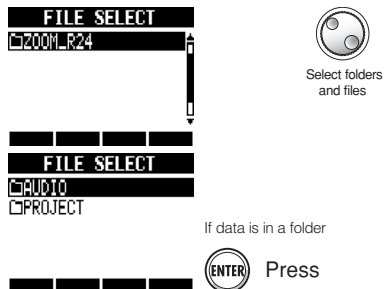

6 Select the file.

FILE SELECT

MONO-000.WAV
MONO-001.WAV
MONO-002.WAV

 Change file

 Press

7 Select where to save it.

PROJECT SELECT

PRJ000
PRJ001
PRJ002
PRJ003
PRJ004

 Change project

 Press

8 Change the file name as necessary.

FILE RENAME

MONO-000

 Move cursor

 DELETE
Delete character

 Change character

 INSERT
Insert character

 Press

9 Select YES.

LOAD: MONO-000.WAV

Are You Sure?

 Move cursor

 Press

Saving projects to USB memory USB>STORAGE>PRJ SAVE

1 **USB**

Press

2 Select STORAGE.

USB

AUDIO I/F
READER
STORAGE

 Change menu

 Press

3 Select PRJ SAVE.

USB STORAGE MENU

FILE SAVE
FILE LOAD
PRJ SAVE
PRJ LOAD
INIT

 Change menu

 Press

4 Select the project.

PROJECT SELECT

PRJ000
PRJ001
PRJ002
PRJ003
PRJ004

 Change project

 Press

5 Change the project name as necessary.

PROJECT RENAME

PRJ000

 Move cursor

 DELETE
Delete character

 Change character

 INSERT
Insert character

 Press

6 Select YES.

SAVE: PRJ000

Are You Sure?

 Move cursor

 Press

Loading projects from USB memory

USB>STORAGE>PRJ LOAD

- 1 Press
- 2 Select STORAGE.
 Change menu
 Press
- 3 Select PRJ LOAD.
 Change menu
 Press
- 4 Select the project.
 Change project
 Press
- 5 Change the project name as necessary.
 Move cursor Delete character
 Insert character
 Press
 EXIT
 INSERT
- 6 Select YES.
 Move cursor
 Press

Creating an R24 folder on the USB memory

USB>STORAGE>INIT

- 1 Connect the USB memory to the R24 USB HOST port.
- 2 Press
- 3 Select STORAGE.
 Change menu
 Press
- 4 Select INIT.
 Change menu
 Press
- 5 Select YES.
 Move cursor
 Press

USB memory folder structure

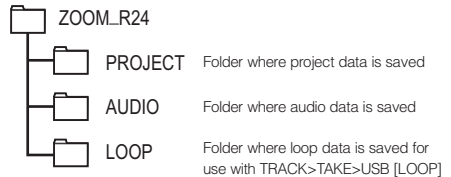

NOTE

- Never remove USB memory when sending or receiving data. Disconnect after the "Saving" or "Loading" display closes.
- During USB storage use, recorder operations are not possible.
- When saving on USB memory, the saved data is stored in the AUDIO and PROJECT folders inside the ZOOM_R24 folder.
- If a file or project with the same name already exists, an "Overwrite?" confirmation pop-up appears. Press EXIT to cancel overwriting and change the name or select a new project.

Audio interface/control surface

Connect the R24 by USB to a computer to use it as an audio interface to input and output sound and as a controller for DAW software.

Connecting the unit as an audio interface/control surface

1 Audio interface

The R24 can be used as an interface between a computer and instruments and other audio equipment, allowing audio signals to be recorded directly into DAW software, for example.

You can connect instruments and microphones that require Hi-Z or phantom power when used as an audio interface.

2 Control surface

Use the faders and keys on the R24 to control transport and mixer operations in your DAW software.

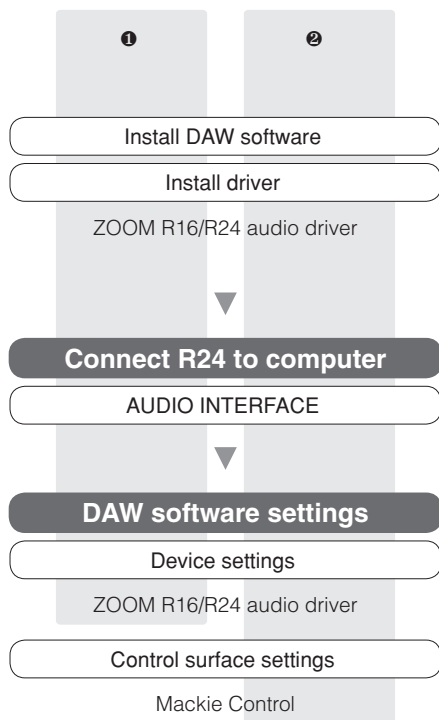

Connecting an R24 to a computer for the first time

- 1 Install the ZOOM R16/R24 Audio Driver on the computer.

 Ref: Cubase LE Startup Guide

- 2 Connect the R24 to the computer.

Set and connect the R24

See "Connecting and setting the R24" on the next page.

- 3 Make DAW software settings

Device settings

Control surface settings

NOTE

- To use the R24 as an audio interface for DAW software (for example, Cubase LE) it is necessary to install the ZOOM R16/R24 Audio Driver. Install it correctly according to the directions given in the included installation guide.
- Download the latest R24 audio driver from the ZOOM website (<http://www.zoom.co.jp>).

Connecting and setting the R24

Follow these procedures after the first time

- 1** **USB** Press 
- 2** Select **AUDIO I/F**.





Change menu

 Press
- 3** Select whether or not to use the settings of the previous project.



Change menu

 Change setting
- 4** Select **EXECUTE**.



Change menu

 Press
- 5** Connect the USB cable to the R24.

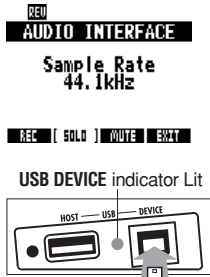

USB DEVICE indicator Lit

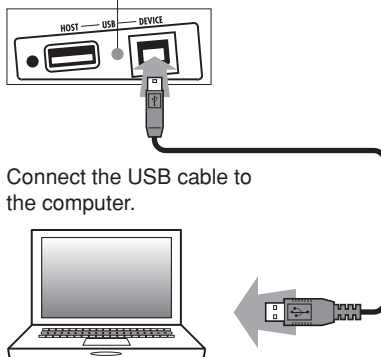
- 6** Connect the USB cable to the computer.

Disconnecting

- 1** **USB** Press 

Press the  below **EXIT**.
- 2** Select **YES**.

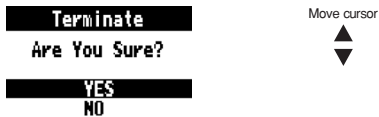

Move cursor

 Press
- 3** Disconnect the USB cable

NOTE

Select **CONTINUE** to use the same settings as last time.

- INSERT EFFECT settings
- SEND RETURN EFFECT settings
- Mixer settings
- TUNER settings

Select **RESET** to restore default settings for each item.

- Before removing the USB cable when disconnecting from a computer, always follow the proper procedures for the computer OS to disconnect the device first.
- Before removing the USB cable, conduct step 2 of "Disconnecting" first.
- The audio interface and control surface functions of the R24 can be used by drawing power through a USB cable from the USB bus.
- We recommend always using the latest R24 system software. If you use an R24 running an older system, a computer might not recognize it properly.

Rhythm pattern list

Patterns 35~234 are typical patterns and fills for various genres.

No.	Name	Beats
Variation		
0	08Beat01	4
1	08Beat02	4
2	08Beat03	4
3	08Beat04	4
4	08Beat05	4
5	08Beat06	4
6	08Beat07	4
7	08Beat08	4
8	08Beat09	4
9	08Beat10	4
10	08Beat11	4
11	08Beat12	4
12	16Beat01	4
13	16Beat02	2
14	16Beat03	4
15	16Beat04	4
16	16Beat05	4
17	16Beat06	4
18	16Beat07	2
19	16Beat08	2
20	16Beat09	4
21	16Beat10	4
22	16Beat11	4
23	16Beat12	4
24	16FUS01	2
25	16FUS02	2
26	16FUS03	4
27	16FUS04	2
28	04JAZZ01	4
29	04JAZZ02	4
30	04JAZZ03	4
31	04JAZZ04	4
32	DANCE	2
33	CNTRY	2
34	68BLUS	4
No.	Name	Beats
Variation		
35	ROCKs1VA	2
36	ROCKs1VB	1
37	ROCKs1FA	1
38	ROCKs1VB	2
39	ROCKs1Vb	1
40	ROCKs1FB	1
41	ROCKs2VA	2
42	ROCKs2Va	1

43	ROCKs2FA	1
44	ROCKs2VB	2
45	ROCKs2Vb	1
46	ROCKs2FB	1
47	ROCKs3VA	1
48	ROCKs3FA	1
49	ROCKs3VB	1
50	ROCKs3FB	1
51	ROCKs4VA	2
52	ROCKs4Va	1
53	ROCKs4FA	1
54	ROCKs4VB	2
55	ROCKs4Vb	1
56	ROCKs4FB	1
57	HRKs1VA	1
58	HRKs1FA	1
59	HRKs1VB	1
60	HRKs1FB	1
61	HRKs2VA	2
62	HRKs2Va	1
63	HRKs2FA	1
64	HRKs2VB	2
65	HRKs2Vb	1
66	HRKs2FB	1
67	MTLs1VA	1
68	MTLs1FA	1
69	MTLs1VB	1
70	MTLs1FB	1
71	FUSs1VA	2
72	FUSs1Va	1
73	FUSs1FA	1
74	FUSs1VB	2
75	FUSs1Vb	1
76	FUSs1FB	1
77	FUSs2VA	2
78	FUSs2Va	1
79	FUSs2FA	1
80	FUSs2VB	2
81	FUSs2Vb	1
82	FUSs2FB	1
83	FUSs3VA	2
84	FUSs3Va	1
85	FUSs3FA	1
86	FUSs3VB	2
87	FUSs3Vb	1
88	FUSs3FB	1
89	INDTs1VA	2

90	INDTs1Va	1
91	INDTs1FA	1
92	INDTs1VB	2
93	INDTs1Vb	1
94	INDTs1FB	2
95	POPs1VA	2
96	POPs1Va	1
97	POPs1FA	1
98	POPs1VB	2
99	POPs1Vb	1
100	POPs1FB	1
101	RnBs1VA	2
102	RnBs1Va	1
103	RnBs1FA	2
104	RnBs1VB	2
105	RnBs1Vb	1
106	RnBs1FB	1
107	RnBs2VA	2
108	RnBs2Va	1
109	RnBs2FA	1
110	RnBs2VB	2
111	RnBs2Vb	1
112	RnBs2FB	1
113	MTNs1VA	2
114	MTNs1Va	1
115	MTNs1FA	1
116	MTNs1VB	2
117	MTNs1Vb	1
118	MTNs1FB	1
119	FUNKs1VA	2
120	FUNKs1Va	1
121	FUNKs1FA	1
122	FUNKs1VB	2
123	FUNKs1Vb	1
124	FUNKs1FB	1
125	FUNKs2VA	2
126	FUNKs2Va	1
127	FUNKs2FA	1
128	FUNKs2VB	2
129	FUNKs2Vb	1
130	FUNKs2FB	1
131	HIPs1VA	2
132	HIPs1Va	1
133	HIPs1FA	1
134	HIPs1VB	2
135	HIPs1Vb	1
136	HIPs1FB	1

137	HIPs1VC	2
138	HIPs1Vc	1
139	HIPs1VD	2
140	HIPs1Vd	1
141	HIPs2VA	2
142	HIPs2Va	1
143	HIPs2VB	2
144	HIPs2Vb	1
145	HIPs2FB	1
146	HIPs2VC	2
147	HIPs2Vc	1
148	HIPs2VD	2
149	DANCs1VA	1
150	DANCs1FA	1
151	DANCs1VB	1
152	DANCs1FB	1
153	DANCs2VA	2
154	DANCs2Va	1
155	DANCs2FA	1
156	DANCs2VB	2
157	DANCs2Vb	1
158	DANCs2FB	1
159	HOUSs1VA	1
160	HOUSs1FA	1
161	HOUSs1VB	1
162	HOUSs1FB	1
163	TECHs1VA	1
164	TECHs1FA	1
165	TECHs1VB	1
166	TECHs1FB	1
167	DnBs1VA	2
168	DnBs1Va	1
169	DnBs1FA	1
170	DnBs1VB	2
171	DnBs1Vb	1
172	DnBs1FB	1
173	TPs1VA	1
174	TPs1FA	1
175	TPs1VB	1
176	TPs1FB	1
177	AMBs1VA	2
178	AMBs1Va	1
179	AMBs1FA	1
180	AMBs1VB	1
181	BALDs1VA	2
182	BALDs1Va	1
183	BALDs1FA	1

184	BALDs1VB	2
185	BALDs1Vb	1
186	BALDs1FB	1
187	BLUSs1VA	2
188	BLUSs1Va	1
189	BLUSs1VB	1
190	BLUSs1Vb	2
191	BLUSs1FB	1
192	BLUSs1FB	1
193	CNTRs1VA	2
194	CNTRs1Va	1
195	CNTRs1FA	1
196	CNTRs1VB	2
197	CNTRs1Vb	1
198	CNTRs1FB	1
199	JAZZs1VA	2
200	JAZZs1Va	1
201	JAZZs1FA	1
202	JAZZs1VB	2
203	JAZZs1Vb	1
204	JAZZs1FB	1
205	AFROs1VA	2
206	AFROs1Va	1
207	AFROs1FA	1
208	AFROs1VB	2
209	AFROs1Vb	1
210	AFROs1FB	1
211	REGGs1VA	2
212	REGGs1Va	1
213	REGGs1VB	1
214	REGGs1Vb	1
215	REGGs1FB	1
216	REGGs1FB	1
217	LATNs1VA	2
218	LATNs1Va	1
219	LATNs1FA	1
220	LATNs1VB	2
221	LATNs1Vb	1
222	LATNs1FB	1
223	LATNs2VA	2
224	LATNs2Va	1
225	LATNs2FA	1
226	LATNs2VB	2
227	LATNs2Vb	1
228	LATNs2FB	1
229	MidEs1VA	2
230	MidEs1Va	1

231	MidEs1FA	1	281	FUS04	2	333	HIP14	2	385	BALD09	2	437	LATN12	2
232	MidEs1VB	2	282	FUS05	2	334	HIP15	2	386	BALD10	2	438	BOSSA01	4
233	MidEs1Vb	1	283	FUS06	2	335	HIP16	2	387	BALD11	4	439	BOSSA02	4
234	MidEs1FB	1	284	FUS07	2	336	HIP17	2	388	BLUS01	2	440	SAMBA01	4
No.	Name	Beats	285 <td>FUS08</td> <td>2</td> <th>337<td>HIP18</td><td>2</td><td>389</td><td>BLUS02</td><td>2</td><td>441</td><td>SAMBA02</td><td>4</td></th>	FUS08	2	337 <td>HIP18</td> <td>2</td> <td>389</td> <td>BLUS02</td> <td>2</td> <td>441</td> <td>SAMBA02</td> <td>4</td>	HIP18	2	389	BLUS02	2	441	SAMBA02	4
Variation			286 <td>POP01</td> <td>2</td> <th>338<td>HIP19</td><td>2</td><td>390</td><td>BLUS03</td><td>2</td><td>442</td><td>MidE01</td><td>2</td></th>	POP01	2	338 <td>HIP19</td> <td>2</td> <td>390</td> <td>BLUS03</td> <td>2</td> <td>442</td> <td>MidE01</td> <td>2</td>	HIP19	2	390	BLUS03	2	442	MidE01	2
235	ROCK01	2	287	POP02	2	339	HIP20	2	391	BLUS04	2	443	MidE02	2
236	ROCK02	2	288	POP03	2	340	HIP21	2	392	BLUS05	2	444	MidE03	2
237	ROCK03	2	289	POP04	2	341	HIP22	2	393	BLUS06	2	445	MidE04	2
238	ROCK04	2	290	POP05	2	342	HIP23	2	394	CNTR01	2	446	INTRO01	1
239	ROCK05	2	291	POP06	2	343	DANC01	2	395	CNTR02	2	447	INTRO02	1
240	ROCK06	2	292	POP07	2	344	DANC02	2	396	CNTR03	2	448	INTRO03	1
241	ROCK07	2	293	POP08	2	345	DANC03	2	397	CNTR04	2	449	INTRO04	1
242	ROCK08	2	294	POP09	2	346	DANC04	2	398	JAZZ01	2	450	INTRO05	1
243	ROCK09	2	295	POP10	2	347	DANC05	2	399	JAZZ02	2	451	INTRO06	1
244	ROCK10	2	296	POP11	2	348	DANC06	2	400	JAZZ03	2	452	INTRO07	1
245	ROCK11	4	297	POP12	2	349	HOUS01	2	401	JAZZ04	2	453	INTRO08	1
246	ROCK12	2	298	RnB01	2	350	HOUS02	2	402	JAZZ05	2	454	INTRO09	1
247	ROCK13	2	299	RnB02	2	351	HOUS03	2	403	JAZZ06	2	455	INTRO10	1
248	ROCK14	2	300	RnB03	2	352	HOUS04	2	404	JAZZ07	4	456	INTRO11	1
249	ROCK15	2	301	RnB04	2	353	TECH01	2	405	SHFL01	2	457	INTRO12	1
250	ROCK16	2	302	RnB05	2	354	TECH02	2	406	SHFL02	2	458	INTRO13	1
251	ROCK17	2	303	RnB06	2	355	TECH03	2	407	SHFL03	2	459	INTRO14	1
252	ROCK18	2	304	RnB07	2	356	TECH04	2	408	SHFL04	2	460	INTRO15	1
253	ROCK19	2	305	RnB08	2	357	TECH05	2	409	SHFL05	2	461	INTRO16	1
254	ROCK20	2	306	RnB09	2	358	TECH06	2	410	SKA01	2	462	INTRO17	1
255	ROCK21	2	307	RnB10	2	359	TECH07	2	411	SKA02	2	463	INTRO18	1
256	ROCK22	2	308	FUNK01	2	360	TECH08	2	412	SKA03	2	464	ENDING01	1
257	ROCK23	2	309	FUNK02	2	361	TECH09	2	413	SKA04	2	465	ENDING02	1
258	ROCK24	2	310	FUNK03	2	362	TECH10	2	414	REGG01	2	466	ENDING03	1
259	ROCK25	2	311	FUNK04	2	363	DnB01	2	415	REGG02	2	467	ENDING04	1
260	ROCK26	2	312	FUNK05	2	364	DnB02	2	416	REGG03	2	468	ENDING05	1
261	ROCK27	2	313	FUNK06	2	365	DnB03	2	417	REGG04	2	469	ENDING06	1
262	ROCK28	2	314	FUNK07	2	366	DnB04	2	418	AFRO01	2	470	ENDING07	1
263	HRK01	2	315	FUNK08	2	367	DnB05	2	419	AFRO02	2	471	COUNT	2
264	HRK02	2	316	FUNK09	2	368	DnB06	2	420	AFRO03	2	472	EMPTY	2
265	HRK03	2	317	FUNK10	2	369	TRIP01	2	421	AFRO04	2	510		
266	HRK04	2	318	FUNK11	2	370	TRIP02	2	422	AFRO05	2			
267	HRK05	2	319	FUNK12	2	371	TRIP03	2	423	AFRO06	2			
268	HRK06	2	320	HIP01	2	372	TRIP04	2	424	AFRO07	2			
269	HRK07	2	321	HIP02	2	373	AMB01	2	425	AFRO08	2			
270	MTL01	2	322	HIP03	2	374	AMB02	2	426	LATN01	2			
271	MTL02	2	323	HIP04	2	375	AMB03	2	427	LATN02	2			
272	MTL03	2	324	HIP05	2	376	AMB04	2	428	LATN03	2			
273	MTL04	2	325	HIP06	2	377	BALD01	2	429	LATN04	2			
274	THRS01	2	326	HIP07	2	378	BALD02	2	430	LATN05	2			
275	THRS02	2	327	HIP08	2	379	BALD03	2	431	LATN06	2			
276	PUNK01	2	328	HIP09	2	380	BALD04	2	432	LATN07	2			
277	PUNK02	2	329	HIP10	2	381	BALD05	2	433	LATN08	2			
278	FUS01	2	330	HIP11	2	382	BALD06	2	434	LATN09	2			
279	FUS02	2	331	HIP12	2	383	BALD07	2	435	LATN10	2			
280	FUS03	2	332	HIP13	2	384	BALD08	2	436	LATN11	2			

Effect types and parameters 1

Effect parameters

Insert effects

Clean/Crunch, Distortion, Aco/Bass SIM algorithms

- COMP/LIMITER module

Type	Parameters/Descriptions			
Compressor	Sense	Attack	Tone	Level
	MXR Dynacomp type compressor.			
Rack Comp	Threshold	Ratio	Attack	Level
	Compressor with more detailed adjustments.			
Limiter	Threshold	Ratio	Release	Level
	Limiter for suppressing signal peaks above a certain level.			

Parameter descriptions

Parameter	Setting range	Description
Sense	0~10	Adjusts compressor sensitivity.
Attack	Compressor: Fast, Slow	Selects compressor response speed.
	Rack Comp: 1~10	Adjusts compressor response speed.
Tone	0~10	Adjusts tonal quality.
Level	2~100	Adjusts signal level after passing module.
Threshold	0~50	Adjusts threshold for compressor/limiter action.
Ratio	1~10	Adjusts compressor/limiter compression ratio.
Release	1~10	Adjusts delay until compressor/limiter release from time when signal level falls below threshold level.

Effect types and parameters 2

• EFX module

Type	Parameters/Descriptions						
Auto Wah	Position	Sense	Resonance	Level			
	Auto wah dependent on dynamics of input signal.						
Tremolo	Depth	Rate	Wave	Level			
	Periodically varies the volume level.						
Phaser	Position	Rate	Color	Level			
	Produces a swooshing sound.						
Ring Modulator	Position	Frequency	Balance	Level			
	Produces a metallic ringing sound. Adjusting the Frequency parameter results in a drastic change of sound character.						
Slow Attack	Position	Time	Curve	Level			
	Slows down the attack rate of the sound.						
Fix-Wah	Position	Frequency	Dry Mix	Level	RTM Mode	RTM Wave	RTM Sync
	Changes the wah frequency according to rhythm tempo.						
Booster	Range	Tone	Level				
	Increases signal gain to make the sound more powerful.						

Parameter descriptions

Parameter name	Setting range	Description
Position	Before, After	Sets connection position of EFX module to before or after preamp.
Sense	-10~-1, 1~10	Adjusts auto wah sensitivity.
Resonance	0~10	Adjusts resonance intensity.
Level	2~100	Adjusts signal level after passing through module.
Depth	0~100	Adjusts modulation depth.
Rate	0~50 ♪ (P124 Table 1)	Adjusts modulation rate. Can be set in rhythm tempo note units.
Wave	Up 0~9, Down 0~9, Tri 0~9	Sets modulation waveform to "Up" (rising sawtooth), "Down" (falling sawtooth) or "Tri" (triangular). Higher values result in stronger clipping, emphasizing the effect.
Color	4Stage, 8Stage, Invert4, Invert8	Selects sound type.
Frequency	Ring Modulator: 1~50	Adjusts frequency used for modulation.
	Fix-Wah: 1~50	Adjusts wah center frequency.
Balance	0~100	Adjusts balance between original sound and effect sound.
Time	1~50	Adjusts rise time for sound.
Curve	0~10	Adjusts volume rise curve.
Dry Mix	0~10	Adjusts original sound mix ratio.
RTM Mode	P124 Table 2	Adjusts change range and direction.
RTM Wave	P124 Table 3	Selects control waveform.
RTM Sync	♪ (P124 Table 4)	Adjusts control wave frequency.
Range	1~5	Selects frequency range to boost.
Tone	0~10	Adjusts tone.

Effect types and parameters 3

• PREAMP module

Type	Parameters
FD Combo	Modeled sound of Fender Twin Reverb ('65 model) favored by guitarists of many music styles
VX Combo	Modeled sound of combo amp VOX AC-30 operating in class A
US Blues	Crunch sound of FENDER Tweed BASSMAN
BG Crunch	Crunch sound of Mesa Boogie MkIII combo amp
HW Stack	Modeled sound of legendary all-tube Hiwatt Custom 100 from Britain
MS Crunch	Crunch sound of legendary Marshall 1959
MS Drive	High gain sound of Marshall JCM2000 stack amp
PV Drive	High gain sound of Peavey 5150 developed in cooperation with a world-famous hard rock guitarist
DZ Drive	High gain sound of the Diezel Herbert hand-made German guitar amp with three separately controllable channels
BG Drive	High gain sound of Mesa Boogie Dual Rectifier red channel (vintage mode)
OverDrive	Modeling of BOSS OD-1 effect pedal that was the world's first overdrive effect of its kind
T Scream	Simulation of the Ibanez TS808, which is loved by many guitarists as a booster and has inspired numerous clones
Governor	Simulation of the Guv'nor distortion effect from Marshall
Dist +	Simulation of the MXR distortion+ effect that made distortion popular worldwide
Dist 1	Simulation of the Boss DS-1 distortion pedal, which has been a long-seller
Squeak	Simulation of the PROCO Rat famous for its edgy distortion sound
FuzzSmile	Simulation of the Fuzz Face, which has made rock history with its humorous panel design and smashing sound
GreatMuff	Simulation of the Electro-Harmonix Big Muff, which is loved by famous artists around the world for its fat, sweet fuzz sound
MetalWRLD	Simulation of the Boss Metal Zone, which is characterized by long sustain and a powerful lower midrange
HotBox	Simulation of the compact Matchless Hotbox pre-amplifier with a built-in tube
Z Clean	ZOOM original unadorned clean sound
Z Wild	A high gain sound with even more overdrive boost.
Z MP1	An original sound created by merging characteristics of an ADA MP1 and a MARSHALL JCM800.
Z Bottom	A high gain sound that emphasizes low and middle frequencies
Z Dream	A high gain sound for lead playing based on the Mesa Boogie Road King Series II Lead channel
Z Scream	An original high gain sound balanced from low to high frequencies
Z Neos	A crunch sound modeled on the sound of a modified VOX AC30
Lead	A bright and smooth distortion sound
ExtremeDS	This distortion effect boasts the highest gain in the world
Acoustic Sim	Top Body Level
	Makes an electric guitar sound like an acoustic guitar
Bass Sim	Tone Level
	Makes an electric guitar sound like a bass guitar

Parameter descriptions

Parameter	Setting range	Explanation
Gain	0~100	Adjusts preamp gain (distortion intensity).
Tone	0~30	Adjusts tonal quality.
Cabinet	Matched	Optimizes cabinet settings according to the drive effect type.
	Combo	Simulates 2x12 Fender combo amp cabinet.
	Tweed	Simulates 4x10 Fender Tweed amp cabinet.
	Stack	Simulates 4x12 Marshall stack amp cabinet.
Level	1~100	Adjusts signal level after passing through module.
Top	0~10	Adjusts characteristic acoustic guitar string resonance.
Body	0~10	Adjusts characteristic acoustic guitar body resonance.

• 6BAND EQ module

Type	Parameters
6Band EQ	Bass Low-Mid Middle Treble Presence Harmonics
	This is an equalizer with 6 frequency bands

Parameter descriptions

Parameter	Setting range	Explanation
Bass	-12dB~12dB	Adjusts low frequency range (160 Hz) boost/cut.
Low-Mid	-12dB~12dB	Adjusts mid-low-frequency range (400 Hz) boost/cut.
Middle	-12dB~12dB	Adjusts middle-frequency range (800 Hz) boost/cut.
Treble	-12dB~12dB	Adjusts high-frequency range (3.2 kHz) boost/cut.
Presence	-12dB~12dB	Adjusts super-high-frequency range (6.4 kHz) boost/cut .
Harmonics	-12dB~12dB	Adjust harmonics (12 kHz) boost/cut.

Effect types and parameters 4

• MOD/DELAY module

Type	Parameters			
Chorus	Depth	Rate	Tone	Mix
	Mixes a variable pitch-shifted component with the original sound, resulting in full-bodied resonating tone			
Ensemble	Depth	Rate	Tone	Mix
	Chorus ensemble features three-dimensional movement			
Flanger	Depth	Rate	Resonance	Manual
	Produces a resonating and strongly undulating sound			
Pitch	Shift	Tone	Fine	Balance
	Shifts the pitch up or down.			
Vibe	Depth	Rate	Tone	Balance
	Adds automatic vibrato			
Step	Depth	Rate	Resonance	Shape
	Special effect makes sound changes in steps.			
Cry	Range	Resonance	Sense	Balance
	Changes sound like a talking modulator.			
Exciter	Frequency	Depth	Low Boost	
	Enhances the sound outline, making it more prominent.			
Air	Size	Reflex	Tone	Mix
	Recreates the airy ambience of a room, with a feeling of depth.			
Delay	Time	Feedback	Hi Damp	Mix
	Delay effect with a maximum setting of 2000 ms.			
Analog Delay	Time	Feedback	Hi Damp	Mix
	Warm analog delay simulation with up to 2000 msec delay length.			
Reverse Delay	Time	Feedback	Hi Damp	Balance
	Reverse delay with a maximum length of 1000 msec.			
ARRM Pitch	Type	Tone	RTM Wave	RTM Sync
	Changes pitch of original sound in time with the rhythm tempo .			

Parameter descriptions

Parameter	Setting range	Explanation
Depth	Exciter: 0~30	Adjusts depth of effect.
	Other: 0~100	Adjusts modulation depth.
Rate	Chorus, Ensemble: 1~50	Adjusts modulation speed.
	Flanger, Vibe, Step: 0~50 ♪ (P124 Table 1)	Adjusts modulation speed. Using the rhythm tempo as reference, setting in note units is also possible..
Tone	0~10	Adjusts tonal quality.
Mix	0~100	Adjusts mix ratio of effect sound to original sound.
Resonance	Flanger: -10~10	Adjusts resonance intensity. Negative values result in reversed phase for the effect sound.
	Step, Cry: 0~10	Adjusts resonance intensity.
Manual	0~100	Adjust the frequency range that is effected.
Shift	-12~12, 24	Sets pitch shift in semitones.
Fine	-25~25	Sets pitch shift in cents (1/100 semitone).
Balance	0~100	Balances effect sound and original sound.
Shape	0~10	Sets effect sound envelope.
Range	1~10	Adjusts the frequency range that is affected.
Sense	-10~-1, 1~10	Sets the sensitivity of the effect.
Frequency	1~5	Adjusts the frequencies that are effected.
Low Boost	0~10	Emphasizes low-frequency range.
Size	1~100	Sets size of simulated space.
Reflex	0~10	Adjusts the amount of reflections from the walls.
Time	Delay, Analog Delay: 1~2000 ms ♪ (P124 Table 1)	Adjusts delay time.
	Reverse Delay: 10~1000 ms ♪ (P124 Table 1)	
Feedback	0~100	Adjusts feedback amount.
Hi Damp	0~10	Adjusts the high-frequency attenuation of the delay sound.
Type	P124 Table 5	Selects the type of pitch change.
RTM Wave	P124 Table 3	Selects the wave shape of the effect.
RTM Sync	P124 Table 4	Sets the frequency of the wave.

Effect types and parameters 5

• REVERB module

Type	Parameters			
Hall	Decay	PreDelay	Tone	Mix
	Simulates the acoustics of a concert hall			
Room	Decay	PreDelay	Tone	Mix
	Simulates the acoustics of a room			
Spring	Decay	PreDelay	Tone	Mix
	Simulates a spring reverb			
Arena	Decay	PreDelay	Tone	Mix
	Simulates the acoustics of an arena-sized venue			
TiledRoom	Decay	PreDelay	Tone	Mix
	Simulates the acoustics of a tiled room			

Parameter descriptions

Parameter	Setting range	Explanation
Decay	1~30	Adjusts reverb time.
PreDelay	1~100	Adjusts pre-delay time.
Tone	0~10	Adjusts tonal quality of effect.
Mix	0~100	Adjusts effect sound volume level.

• ZNR module

Type	Setting Range	Explanation
ZNR	Off, 1~30	Adjusts sensitivity. Set value as high as possible without causing unnatural decay.
	ZOOM original noise reduction for reducing noise during playing pauses without affecting the overall tone.	

Bass algorithm

• COMP/LIMITER module

Type	Parameters
Rack Comp Limiter	For an explanation of types and parameters, see CLEAN, DISTORTION, ACO/BASS SIM algorithms.

• EFX module

Type	Parameters				
Auto Wah	Position	Sense	Resonance	Dry Mix	Level
	This effect varies the wah action according to the intensity of the input signal.				
Tremolo	For an explanation of types and parameters, see CLEAN, DISTORTION, ACO/BASS SIM algorithms.				
Phaser					
Ring Modulator					
Slow Attack					
Fix-Wah					

Parameter descriptions

Parameter	Setting range	Explanation
Position	Before, After	Sets insert position of module to before or after PREAMP module.
Sense	-10~-1, 1~10	Adjusts auto wah sensitivity.
Resonance	0~10	Adjusts resonance intensity.
Dry Mix	0~10	Adjusts original sound mix ratio.
Level	2~100	Adjusts signal level after passing module.

• PREAMP module

Type	Parameters				
SVT	Simulation of Ampeg SVT sound.				
Bassman	Simulation of Fender Bassman sound.				
Hartke	Simulation of Hartke HA3500 sound.				
Super Bass	Simulation of Marshall Super Bass sound.				
SANSAMP	Simulation of Sansamp Bass Driver DI sound.				
Tube Preamp	ZOOM original tube preamplifier sound.				
	Gain	Tone	Cabinet	Balance	Level
All preamp modules have the same parameters.					

Effect types and parameters 6

Parameter descriptions

Parameter	Setting range	Explanation
Gain	0~100	Adjusts preamp gain (distortion depth).
Tone	0~30	Adjusts tonal quality of effect.
Cabinet	0~2	Adjusts intensity of speaker cabinet sound.
Balance	0~100	Adjusts mix balance of signal before and after module.
Level	1~100	Adjusts signal level after passing through module.

• 3BAND EQ module

Type	Parameters			
3Band EQ	Bass	Middle	Treble	Level
	This equalizer has three bands.			

Parameter descriptions

Parameter	Setting range	Explanation
Bass	-12dB~12dB	Boosts/cuts low-frequency range.
Middle	-12dB~12dB	Boosts/cuts middle-frequency range.
Treble	-12dB~12dB	Boosts/cuts high-frequency range.
Level	2~100	Adjusts signal level after passing through module.

• MOD/DELAY module

Type	Parameters
Chorus	For an explanation of types and parameters, see CLEAN, DISTORTION, ACO/BASS SIM algorithms.
Ensemble	
Flanger	
Pitch	
Vibe	
Step	
Cry	
Exciter	
Air	
Delay	
Analog Delay	
Reverse Delay	
ARRM Pitch	

• ZNR module

Type	Parameters
ZNR	For an explanation of types and parameters, see CLEAN, DISTORTION, ACO/BASS SIM algorithms.

Mic algorithm

• COMP/LIMITER module

Type	Parameters
Rack Comp Limiter	For an explanation of types and parameters, see CLEAN, DISTORTION, ACO/BASS SIM algorithms.

• EFX module

Type	Parameters
Tremolo	For an explanation of types and parameters, see CLEAN, DISTORTION, ACO/BASS SIM algorithms.
Phaser	
Ring Modulator	
Slow Attack	
Fix-Wah	

• MIC PRE module

Type	Parameters				
Mic Pre	Type	Tone	Level	De-Esser	Low Cut
	This is a preamplifier for use with external microphones.				

Parameter descriptions

Parameter	Setting Range	Explanation
Type	Vocal, AcousticGt, Flat	Selects preamp characteristics.
Tone	0~10	Adjusts tonal quality of effect.
Level	1~100	Adjusts signal level after passing through module.
De-Esser	Off, 1~10	Sets the reduction of sibilant sounds.
Low Cut	Off, 80~240Hz	Sets filter that reduces low-frequency noise easily picked up by mics.

Effect types and parameters 7

• 3BAND EQ module

Type	Parameters
3Band EQ	For an explanation of types and parameters, see the BASS algorithm.

• MOD/DELAY module

Type	Parameters
Chorus	For an explanation of types and parameters, see CLEAN, DISTORTION, ACO/BASS SIM algorithms.
Ensemble	
Flanger	
Pitch	
Vibe	
Step	
Cry	
Exciter	
Air	
Delay	
Analog Delay	
Reverse Delay	
ARRM Pitch	

• ZNR module

Type	Parameters
ZNR	For an explanation of types and parameters, see CLEAN, DISTORTION, ACO/BASS SIM algorithms.

DUAL MIC algorithm

• COMP/LIMITER L module

Type	Parameters			
Compressor	Threshold	Ratio	Attack	Level
	Reduces variation in signal level.			
Limiter	Threshold	Ratio	Release	Level
	Attenuates signals that exceed a certain level.			

Parameter descriptions

Parameter	Setting range	Explanation
Threshold	-24~0	Adjusts threshold level of compressor/limiter.
Ratio	Compressor: 1~26 Limiter: 1~54, ∞	Adjusts compression ratio of compressor/limiter.
Attack	0~10	Adjusts speed that at which the compressor is activated.
Level	2~100	Adjusts module output level.
Release	0~10	Adjusts speed of limiter release after signal falls below threshold level.

• MIC PREAMP L module

Type	Parameters
Mic Pre	For an explanation of types and parameters, see MIC algorithm.

• 3BAND EQ L module

Type	Parameters
3Band EQ	For an explanation of types and parameters, see BASS algorithm.

• DELAY L module

Type	Parameters		
Delay	Time	Feedback	Mix
	Delay effect with a maximum setting of 2000 ms.		
Echo	Time	Feedback	Mix
	Warm delay effect with a maximum setting of 2000 ms.		
Doubling	Time	Tone	Mix
	Doubling effect that creates body by adding a short delay.		

Parameter descriptions

Parameter name	Setting range	Explanation
Time	Delay, Echo: 1~2000ms ♪ (P124 Table 1) Doubling: 1~100ms	Adjusts delay time.
Feedback	0~100	Adjusts feedback amount.
Tone	0~10	Adjusts tonal quality of effect.
Mix	0~100	Adjusts mix ratio of effect sound to original sound.

Effect types and parameters 8

• COMP/LIMITER R module

Type	Parameters
Compressor	For an explanation of types and parameters, see COMP/LIMITER L algorithm.
Limiter	

• MIC PREAMP R module

Type	Parameters
Mic Pre	For an explanation of types and parameters, see MIC algorithm.

• 3BAND EQ R module

Type	Parameters
3Band EQ	For an explanation of types and parameters, see BASS algorithm.

• DELAY R module

Type	Parameters
Delay	For an explanation of types and parameters, see DELAY algorithm.
Echo	
Reverb	
Doubling	

• ZNR module

Type	Parameters
ZNR L	For an explanation of types and parameters, see CLEAN, DISTORTION, ACO/BASS SIM algorithms.
ZNR R	For an explanation of types and parameters, see CLEAN, DISTORTION, ACO/BASS SIM algorithms.

Stereo algorithm

• COMP/LIMITER module

Type	Parameters												
Compressor	For an explanation of types and parameters, see DUAL MIC algorithm.												
Limiter													
Lo-Fi	<table border="1"> <thead> <tr> <th>Character</th> <th>Color</th> <th>Dist</th> <th>Tone</th> <th>EFX Level</th> <th>Dry Level</th> </tr> </thead> <tbody> <tr> <td colspan="6">This effect intentionally reduces the quality of the sound.</td> </tr> </tbody> </table>	Character	Color	Dist	Tone	EFX Level	Dry Level	This effect intentionally reduces the quality of the sound.					
Character	Color	Dist	Tone	EFX Level	Dry Level								
This effect intentionally reduces the quality of the sound.													

Parameter descriptions

Parameter	Setting range	Explanation
Character	0~10	Adjusts filter characteristics.
Color	1~10	Adjusts sound color.
Dist	0~10	Adjusts distortion.
Tone	0~10	Adjusts tonal quality of effect.
EFX Level	0~100	Adjusts effect sound level.
Dry Level	0~100	Adjusts original sound level.

• ISO/MIC MODEL module

Type	Parameters										
Isolator	<table border="1"> <thead> <tr> <th>Xover Lo</th> <th>Xover Hi</th> <th>Mix High</th> <th>Mix Mid</th> <th>Mix Low</th> </tr> </thead> <tbody> <tr> <td colspan="5">Divides the signal into three frequency bands and allows the mix amount of each band to be adjusted separately.</td> </tr> </tbody> </table>	Xover Lo	Xover Hi	Mix High	Mix Mid	Mix Low	Divides the signal into three frequency bands and allows the mix amount of each band to be adjusted separately.				
Xover Lo	Xover Hi	Mix High	Mix Mid	Mix Low							
Divides the signal into three frequency bands and allows the mix amount of each band to be adjusted separately.											
Mic Modeling	<table border="1"> <thead> <tr> <th>Mic Type</th> </tr> </thead> <tbody> <tr> <td>Changes built-in mic characteristics.</td> </tr> </tbody> </table>	Mic Type	Changes built-in mic characteristics.								
Mic Type											
Changes built-in mic characteristics.											

Parameter descriptions

Parameter	Setting range	Explanation
Xover Lo	50Hz~16kHz	Adjusts low-to-mid crossover frequency.
Xover Hi	50Hz~16kHz	Adjusts mid-to-high crossover frequency.
Mix High	Off, -24 ~6	Adjusts high frequency range mix level.
Mix Mid	Off, -24 ~6	Adjusts mid frequency range mix level.
Mix Low	Off, -24 ~6	Adjusts low frequency range mix level.
Mic Type	SM57	Simulation of SM57 mic, which is great for recording electric guitars and other analog instruments.
	MD421	Simulation of MD421 professional standard mic that is indispensable in broadcasting, recording and live performances.
	U87	Simulation of U87, a condenser type microphone that sets standards and is used in studios worldwide.
	C414	Simulation of C414, a famous microphone highly trusted in recording situations.

Effect types and parameters 9

• 3BAND EQ module

Type	Parameters
3Band EQ	For an explanation of types and parameters, see BASS algorithm.

• MOD/DELAY module

Type	Parameters							
Chorus	Depth		Rate		Mix			
	Mixes a variable pitch-shifted component with the original sound, resulting in full-bodied resonating tone.							
Flanger	Depth		Rate		Resonance			
	Produces a resonating and strongly undulating sound.							
Phaser	Rate		Color		LFO Shift			
	Produces a swooshing sound.							
Tremolo	Depth		Rate		Clip			
	Periodically varies the volume level.							
Auto Pan	Width		Rate		Clip			
	Swings the panning position of the sound between left and right.							
Pitch	Shift		Tone		Fine		Balance	
	Shifts the pitch up or down.							
Ring Modulator	For an explanation of types and parameters, see CLEAN, DISTORTION, ACO/BASS SIM algorithms.							
Delay	Time		Feedback		Mix			
	Delay effect with a maximum setting of 2000 ms.							
Echo	Time		Feedback		Mix			
	Warm delay effect with a maximum setting of 2000 ms.							
Doubling	Time		Tone		Mix			
	Doubling effect which creates body by adding a short delay.							
Dimension	Rise1		Rise2					
	Expands sound spatially.							
Resonance	Depth	Freq OFST	Rate	Filter	Resonance	EFX Level	Dry Level	
	Resonant filter with LFO.							

Parameter descriptions

Parameter	Setting range	Explanation
Depth	0~100	Adjusts modulation depth.
Resonance	-10~10	Adjusts resonance intensity. Negative values result in reversed phase for the effect sound.
Color	4Stage, 8Stage, Invert4, Invert8	Selects sound type.
LFO Shift	0~180	Adjusts left/right phase shift.
Width	0~10	Adjusts auto pan width.
Rate	0~50 ♪ (P124 Table 1)	Adjusts modulation speed. Using the rhythm tempo as reference, setting in note units is also possible.
Clip	0~10	Adds emphasis by clipping the modulation waveform.
Shift	12~12, 24	Adjusts the pitch shift in semitones.
Time	Delay, Echo: 1~2000ms ♪ (P124 Table 1)	Adjusts delay time.
	Doubling: 1~100ms	
Feedback	0~100	Adjusts feedback amount.
Mix	~100	Adjusts mix ratio of effect sound to original sound.
Tone	~10	Adjusts tonal quality of effect.
Fine	-25~25	Adjusts the pitch shift in cents (1/100 semitone).
Balance	0~100	Adjust balance between original sound and effect sound.
Rise1	0~30	Adjusts stereo component intensity.
Rise2	0~30	Adjusts width including mono elements.
Freq OFST	1~30	Adjusts LFO offset.
Filter	HPF, LPF, BPF	Selects filter type.
Resonance	1~30	Adjusts resonance intensity.
EFX Level	0~100	Adjusts effect sound level.
Dry Level	0~100	Adjusts original sound level.

• ZNR module

Type	Parameters
ZNR	For an explanation of types and parameters, see CLEAN, DISTORTION, ACO/BASS algorithms.

Effect types and parameters 10

Table 1 Parameters marked with ♪ allow values to be set in note units, using the song/pattern tempo as reference. The note durations for the setting values are shown below.

♪	32nd note	♪.	Dotted 16th note	♪.	Dotted 8th note	♪x2	Delay, Analog Delay and Echo can use up to x8. Reverse Delay can use up to x4.
♪	16th note	♪	8th note	♪	Quarter note	:	
♪3	Quarter note triplet	♪3	Half note triplet	♪.	Dotted quarter note	♪x20	

NOTE

- The note range actually available depends on the parameter.
- Depending on the combination of tempo setting and selected note symbol, the parameter variation range could be exceeded. In such a case, the value is automatically halved (or set to 1/4 if the range is still exceeded).

Table 2

Setting	Explanation
Off	Frequency does not change.
Up	Frequency changes from minimum to maximum along with the controlling waveform.
Down	Frequency changes from maximum to minimum along with the controlling waveform.
Hi	Frequency changes from patch setting to maximum along with the controlling waveform.
Lo	Frequency changes from minimum to patch setting along with the controlling waveform.

Table 5

Setting	Explanation
1	1 semitone lower → original sound
2	Original sound → 1 semitone lower
3	Doubling → detune + original sound
4	Detune + original sound → doubling
5	Original sound → 1 octave higher
6	1 octave higher → original sound
7	Original sound → 2 octaves lower
8	2 octaves lower → original sound
9	1 octave higher + original sound → 1 octave lower + original sound
10	Complete fifth down + original sound → complete fourth up + original sound
11	Complete fourth up + original sound → complete fifth down + original sound
12	0 Hz + original sound → 1 octave up
13	1 octave up → 0 Hz + original sound
14	0 Hz + original sound → 1 octave up + original sound
15	1 octave up + original sound → 0 Hz + original sound
16	1 octave up + original sound → 0 Hz + original sound

Table 3

Setting	Explanation	Setting	Explanation
Up Saw	Rising sawtooth wave	Tri	Triangular wave
Up Fin	Rising fin wave	TrixTri	Squared triangular wave
DownSaw	Falling sawtooth wave	Sine	Sine wave
DownFin	Falling fin wave	Square	Square wave

Table 4

Setting	Explanation	Setting	Explanation
♪	8th note	1 bar	1 measure
♪	Quarter note	2 bars	2 measures
♪	Half note	3 bars	3 measures
♪.	Dotted half note	4 bars	4 measures

Bx Comp EQ algorithm

Module 1~8

Unit	Type	Setting range	Explanation
HPF Freq	HPF	80~240Hz	Sets the cut off frequency. This filter cuts low frequencies and passes high-frequencies.
Comp Type	Rack Comp		For an explanation of types and parameters, see CLEAN, DISTORTION, ACO/BASS SIM algorithms.
	Limiter		
EQ Type	See the BASS algorithm for details.		

Mastering algorithm

• **COMP/Lo-Fi module**

Type	Parameters							
	Xover Lo	Xover Hi	Sense Hi	Sense Mid	Sense Low	Mix High	Mix Mid	Mix Low
3Band Comp	Compressor that divides signal into 3 bands that can be compressed and mixed separately.							
Lo-Fi	For an explanation of the types and parameters, see the STEREO algorithm.							

Parameter descriptions

Parameter	Setting range	Explanation
Xover Lo	50Hz~16kHz	Adjusts low-to-mid crossover frequency.
Xover Hi	50Hz~16kHz	Adjusts mid-to-high crossover frequency.
Sense Hi	0~24	Adjusts high range compressor sensitivity.
Sense Mid	0~24	Adjusts mid range compressor sensitivity.
Sense Low	0~24	Adjusts low range compressor sensitivity.
Mix High	Off, -24~6	Adjusts high frequency range mix level.
Mix Mid	Off, -24~6	Adjusts mid frequency range mix level.
Mix Low	Off, -24~6	Adjusts low frequency range mix level.

Effect types and parameters 11

• NORMALIZER module

Type	Parameters	
Normalizer	Gain	
	Adjusts COMP/Lo-Fi module input level..	

Parameter descriptions

Parameter	Setting range	Explanation
Gain	-12~12	Adjusts level.

• 3BAND EQ module

Type	Parameters
3Band EQ	For an explanation of types and parameters, see BASS algorithm.

• DIMENSION/RESO module

Type	Parameters
Dimension Resonance	For an explanation of types and parameters, see the STEREO algorithm..

• ZNR module

Type	Parameters
ZNR	For an explanation of types and parameters, see CLEAN, DISTORTION, ACO/BASS SIM algorithms.

Send-return effects

• CHORUS/DELAY module

Type	Parameters					
Chorus	LFO Type	Depth	Rate	Pre Delay	EFX Level	
	Mixes a variable pitch-shifted component with the original sound, resulting in full-bodied resonating tone.					
Delay	Time	Feedback	Hi Damp	Pan	EFX Level	Rev Send
	Delay effect with a maximum delay of 2000 ms.					

Parameter descriptions

Parameter	Setting range	Explanation
LFO Type	Mono, Stereo	Sets LFO phase to mono or stereo.
Depth	0~100	Adjusts effect depth.
Rate	1~50	Adjusts modulation speed.
Pre Delay	1~30	Adjusts pre-delay time.
EFX Level	0~100	Adjusts effect sound level.
Rev Send	0~30	Adjusts delay sound reverb send level.
Time	1~2000ms ♪ (124 Table 1)	Adjusts delay time.
Feedback	0~100	Adjusts feedback amount.
Hi Damp	0~10	Adjusts amount high-frequency range in delay sound is reduced.
Pan	Left10~Left1, Center, Right1~Right10	Adjusts delay sound panning.

• REVERB module

Type	Parameters					
Hall	Simulates the acoustics of a concert hall.					
Room	Simulates the acoustics of a room.					
	Pre Delay	Decay	EQ High	EQ Low	E.R.Mix	EFX Level
Hall and Room have the same parameters.						
Spring	Simulates a spring reverb.					
Plate	Simulates a plate reverb.					
	Pre Delay	Decay	EQ High	EQ Low	EFX Level	
Spring and Plate have the same parameters.						

Parameter descriptions

Parameter	Setting range	Explanation
Pre Delay	1~100	Adjusts pre-delay time.
Decay	1~30	Adjusts reverb time.
EQ High	-12~6	Adjusts volume of high-frequency range effect sound.
EQ Low	-12~6	Adjusts volume of low-frequency range effect sound.
E.R.Mix	0~30	Adjusts mix ratio of initial reflections.
EFX Level	0~30	Adjusts effect sound level.

Effect patch list 1

Effect patch list

Insert effects

Clean/Crunch algorithm		
No.	Patch name	Description
0	Z CLEAN	ZOOM original unadorned clean sound
1	Z CHORUS	Sound combines "Z CLEAN" with "Chorus" for a clear sound that is great for arpeggios
2	FdClean	Clean-crunch sound of Fender Twin Reverb black panel loved by guitarists of various genres
3	VxCrunch	British crunch sound of a VOX AC30 operating in Class A
4	TWEED	Fender Bassman recreation dry crunch sound with a suitable amount of sustain
5	BgCrunch	Mesa/Boogie MKIII combo amp crunch sound
6	HwLight	Hiwatt Custom 100 from clean to crunch
7	MsCrunch	Marshall 1959 crunch sound becomes cleaner as the guitar volume is reduced
8	HwCrunch	Hiwatt Custom 100 fat crunch sound
9	JM Lead	Compressed lead sound of John Mayer's "Gravity"
10	BS Riff	Brian Setzer's rockabilly sound from the Stray Cats' "Rock This Town"
11	BROTHER	George Benson's unique fat jazz sound is mellow an with an attack
12	Edge	Bright and clean sound with U2 guitarist The Edge's finely calculated delay added
13	ClnStep	Special effect sound that imagines water using "Z CLEAN" and "Step"
14	CutPhase	Phase sound with great attack is perfect for cutting guitar and other playing techniques
15	Ambient	Combination of "Slow Attack" and delay to create an ambient sound
16	Space	Combination of "Reverse Delay" and phaser creates a clean sound with width
17	FdComp	Fender Twin Reverb and compressor clean sound great for cutting guitar
18	Fd Wah	Auto-wah patch with the natural distortion of an FD Combo amp added as the secret ingredient
19	60sSPY	Bizarre sound similar to a 60's spy movie
20	Flower	Combination of phaser and "Vibe" crates a psychedelic worldly sound
21-29	Empty	

Distortion algorithm		
No.	Patch name	Description
0	MsDrive	Marshall 1959 drive sound that follows volume changes and provides outstanding dynamics
1	MdRhythm	Marshall JCM2000 sound for backing parts is heavy, but still has the unique Marshall sound
2	PvRhythm	Peavey 5150 backing part sound with bite that stands out when riffing fast
3	DzRhythm	Diesel Herbert sound for heavy backing parts
4	Recti	Unique powerful thick sound of the MESA/BOOGIE Rectifier
5	FullVx	Sound of Vox AC30 at full volume with room reverb that creates a boxy feeling.
6	TexasMan	Texas blues sound of a Fender Bassman with the volume all the way up
7	BgLead	MESA/BOOGIE MKIII beautiful drive sound great for lead play with long sustain
8	FatOd	Natural overdriven sounds like OD-1 with EQ and can be used backing part and solos
9	TsDrive	Tube Screamer overdrive good for all around use
10	GvDrive	Guv'nor pedal is great for hard rock sound
11	dist+	Drive sound with distortion
12	DS1	DS-1 sound modified with extra low end
13	RAT	Well sustained lead sound of RAT
14	FatFace	Fuzz sound with enhanced FUZZ FACE low end
15	MuffDrv	BIG MUFF high gain sound
16	M World	Shrapnel-style guitarist sound using Metal Zone
17	HOT DRV	Mild driven sound made by the tube saturation of HOT BOX tubes
18	Z NEOS	Recreation of modified VOX AC30 creamy crunch sound.
19	Z WILD	ZOOM's original hard overdrive sound with extra boost creates a compressed feeling
20	Z MP1	Hybrid sound from combination of ADA MP1 and Marshall JCM800
21	Z Bottom	ZOOM original high gain sound with rich mids and lows that is great for 80's metal
22	Z DREAM	ZOOM original high gain sound great for leads
23	Z SCREAM	ZOOM original high gain sound with balanced low to high frequencies cuts through mix
24	LEAD	ZOOM's classic lead sound with strong mid-boost and long sustain necessary for soloing
25	EXT DS	Extreme digital distortion that pushes the limits
26	EC LEAD	Recreation of Eric Clapton's "Layla" lead Fender crunch sound is great sound for guitars with single-coil pickups.
27	JimiFuzz	Jimi Hendrix phase sound simulates Octavia using "PitchSHIFT"
28	DT Slide	Tight tube-amp sound of "Leaving Trunk" by Derek Trucks
29	KC Solo	Nirvana "Smells Like Teen Spirit" sound

Effect patch list 2

30	Every BG	Buddy Guy's blues sound is dry and overdriven and adds color to any blues lick
31	EVH1959	Early Eddie Van Halen sound
32	BrianDrv	Brian May drive sound recreated using "Z Neos"
33	RitchStd	Sound that Deep Purple's Ritchie Blackmore used recording "Machine Head"
34	Carlos	Smooth sound used by Carlos Santana in album recording recreated using "BG Crunch"
35	PeteHW	Pete Townshend crunch sound using Hiwatt with clean amp turned all the way up for a powerful tone
36	JW Talk	Recreation of the talkbox sound used by Joe Walsh in his "Rocky Mountain Way" solo
37	Kstone	Keith Richards's classic intro sound can be heard in The Rolling Stones' "Satisfaction"
38	RR Mtl	80's Metal sound with distinctive midrange based on the Metal Zone
39	SV LEAD	Stack sound that boldly cuts through the midrange is good for huge guitar solos
40	Monster	Weird tone that mixes a heavy sound with a doubling an octave down
41	FatMs	Drive sound with detuning added to thicken the sound is great for power chords and backing parts
42	SlowFlg	Jet sound combining "Slow Attack" with flanger
43	DmgFuzz	Psychedelic tone that adds "Ring Modulator" to fuzz sound that cuts fiercely through low frequencies
44	Recti Wah	Bold high gain sound with auto-wah and a short delay added
45-49	Empty	

Aco/Bass SIM algorithm

No.	Patch name	Description
0	Ensemble	Gorgeous sound with deep ensemble effect.
1	Delay LD	Lively acoustic guitar sound for lead playing.
2	Chorus	Chorus sound suitable for everything from rhythm guitar to lead guitar.
3	FineTune	Detuning creates sonic depth.
4	Air Aco	Air sound makes it sound like recording with a mic.
5	Standard	Standard bass sound with many uses.
6	CompBass	Bass sound comes alive with compressor and exciter.
7	WarmBass	Bass sound with warm and round feeling.
8	Flanging	Flanging sound covers a lot of ground from 16-beat phrases to melody playing.
9	Auto Wah	Funky bass sound that makes good use of auto wah-
10-19	Empty	

Bass algorithm

No.	Patch name	Description
0	SVT	Royal rock sound great for finger-picking and flatpicking.
1	BASSMAN	Vintage rock sound for any occasion.
2	HARTKE	Hartke simulation with all the glitz and glitter.
3	SUPER-B	Great for guitar unison and solo play.
4	SANS-A	Edgy sound with a strong core that is a good match for flatpicking.
5	TUBE PRE	All-round tube sound.
6	Attack	Compression sound effective for slap and flatpick playing.
7	Wah-Solo	Solo sound with distortion and a touch of wah. Pitch shift is the secret ingredient.
8	Talk&Cry	Typical special effect that makes a crying sound like a talking modulator.
9	Melody	Chorus sound for melody, solo, chord and harmonic playing.
10	SlapJazz	Basic slap sound in the jazz bass style.
11	Destroy	Smashing sound mixing distortion, pitch shifting and ring modulation.
12	Tremolo	Great match for moody bass lines and chord playing.
13	SoftSlow	Melody or solo play tone that is great for fretless bass.
14	Limiter	Limiter evens out the sound when using a pick.
15	X'over	Flanger sound for picking, typical of the crossover genre.
16	CleanWah	Auto wah sound that has many uses.
17	Exciter	All-around sound with a fresh and transparent character.
18	ClubBass	Sound that simulates the ambience of a small club and is suitable for walking bas lines.
19	DriveWah	Auto wah sound with variable drive that follows picking dynamics.
20-29	Empty	

Mic algorithm

No.	Patch name	Description
0	Rec Comp	Conventional preamp and compression sound for recording.
1	RoomAmbi	Simulates the ambience of a radio station studio.
2	VocalDly	Delay effect that works best with wet vocals. .
3	Rock	Heavy compression sound for rock vocals

Effect patch list 3

4	Long DLY	Long delay sound for vocals (2-beat at 120 bpm)
5	InTheBOX	This effect seems to put the entire sound into a small box
6	Limiter	Limiting effect that is very useful for recording
7	AG MIC	Preamp tone that is great for recording acoustic guitar
8	AG Dub	Doubling sound that gives a stroke more of a pick feeling
9	12st Cho	Chorus sound for 12-string guitar
10	AG-Jumbo	Increases the apparent body size of an acoustic guitar
11	AG-Small	Reduces the apparent body size of an acoustic guitar
12	AG Lead	Delay sound for acoustic guitar leads
13	Live AMB	Bright reverb sound for acoustic guitar increases the live feeling
14	Tunnel	Simulation of tunnel reverb
15	Filter	Filter effect lets you change the sound character during a song, for example.
16	BrethCmp	Fairly strong compressor sound emphasizes breathiness
17	Vib MOD	Crafty vocal sound combines phaser and vibrato
18	Duet Cho	Detuned sound creates an instant duet
19	Ensemble	Fresh ensemble sound great for chorus
20	VocalDub	Conventional doubling sound
21	Sweep	Voice sound with slow phase sweep
22	VoiceFlg	Flanging chorus sound with strong modulation
23	PH Voice	Gimmicky phase sound seasoned with delay
24	VibVoice	Clear-cut vibrato sound
25	FutureVo	A message from the aliens
26	M to F	Transforms male vocals into a female sound
27	F to M	Transforms female vocals into a male sound
28	WaReWaRe	Special effect sounds like a talking spaceman
29	Hangul	Special effect makes Japanese sound like Korean
30-49	Empty	

Dual Mic algorithm

No.	Patch name	Description	Suggested left/right inputs
0	Vo/Vo 1	For duets	Vocals
1	Vo/Vo 2	Chorus for main vocals	Vocals
2	Vo/Vo 3	For harmony singing	Vocals
3	AG/Vo 1	Creates a story-like character	Acoustic guitar/Vocal
4	AG/Vo 2	Similar to AG/Vo 1 but vocal character different	Acoustic guitar/Vocal
5	AG/Vo 3	Aggressively modifies vocal character	Acoustic guitar/Vocal
6	ShortDLY	Short delay sound with effective doubling	Microphones
7	FatDrum	For drum recording with single point stereo mic	Microphones
8	BothTone	Condenser mic sound for men on L channel and women on R channel	Vocals
9	Condnsr	Simulates condenser mic sound with dynamic mic input	Vocals
10	DuoAttack	Chorus for lead vocals with emphasized attack	Vocals
11	Warmth	Warm sound with prominent midrange	Vocals
12	AM Radio	Simulates AM mono radio	Vocals
13	Pavilion	For narration that captures sound of demonstration at an exposition booth	Vocals
14	TV News	TV newscaster sound	Vocals
15	F-Vo/Pf1	For female vocal piano ballads	Vocal/Piano
16	JazzDuo1	Simulates jazz session LP with slightly lo-fi sound	Vocal/Piano
17	Cntmprry	All around sound with distinct variation	Vocal/Piano
18	JazzDuo2	JazzDuo 1 for male vocals	Vocal/Piano
19	Ensemble	For balance of guitar with strong attack and mellow piano	Acoustic guitar/Piano
20	Enhanced	Emphasizes sound characteristics, optimal for ballads	Acoustic guitar/Vocal
21	Warmy	Moderates overbright ambience	Acoustic guitar/Vocal
22	Strum+Vo	Smooth fat sound with midrange enhancement	Acoustic guitar/Vocal
23	FatPlus	Augments weak midrange	Acoustic guitar/Vocal
24	Arp+Vo	Overall solid sound	Acoustic guitar/Vocal
25	ClubDuo	Simulates live sound in small club	Acoustic guitars
26	BigShape	Enhances overall clarity	Acoustic guitars
27	FolkDuo	Fresh and clean sound	Acoustic guitars
28	GtrDuo	Suitable for acoustic guitar duos	Acoustic guitars
29	Bright	Bright, sharp, global feeling	Acoustic guitars
30-49	Empty		

Effect patch list 4

Stereo algorithm		
No.	Patch name	Description
0	Syn-Lead	For single-note synthesizer lead
1	OrganPha	Phaser for synthesizer/organ
2	OrgaRock	Boomy distortion for rock organ
3	EP-Chor	Beautiful chorus for electric piano
4	ClavFlg	Wah for clavinet
5	Concert	Concert hall effect for piano
6	Honkey	Honky-tonk piano simulation
7	PowerBD	Gives bass drum more power
8	DrumFlng	Conventional flanger for drums
9	LiveDrum	Simulates outdoor live doubling
10	JetDrum	Phaser for 16-beat hi-hat
11	AsianKit	Changes a standard kit to an Asian kit
12	BassBost	Emphasizes low-frequency range
13	Mono->St	Gives spaciousness to a mono source
14	AM Radio	AM radio simulation
15	WideDrum	Wide stereo effect for drum machine tracks
16	DanceDrm	Reinforces bass frequencies for dance rhythms
17	Octaver	Adds sound one-octave lower
18	Percushn	Gives air, presence, and stereo spread to percussion
19	MoreTone	Increases midrange frequencies, giving more body to distorted guitar
20	SnrSmack	Emphasizes snappiness of snare sound
21	Shudder!	Sliced sound for techno tracks
22	SwpPhase	Phaser with powerful resonance
23	DirtyBiz	Lo-fi distortion using ring modulator
24	Doubler	Doubling for vocal track
25	SFXlab	Gives synthesizer powerful special effect sound
26	SynLead2	Old-style jet sound for synthesizer lead
27	Tekepiko	For sequenced phrases or single note muted guitar
28	Soliner	Simulates analog strings ensemble
29	HevyDrum	For hard rock drums
30	SM57Sim	Simulation of SM57 mic, which is great for recording electric guitars and other analog instruments.
31	MD421Sim	Simulation of MD421 professional standard mic that is indispensable in broadcasting, recording and live.
32	U87Sim	Simulation of U87, a condenser type microphone that sets standards and is used in studios worldwide.
33	C414Sim	Simulation of C414, a famous microphone highly trusted in recording situations.
34	Doubling	Creates doubled sounds as if the entire sound body became thicker
35	ShortDLY	Delay sound suitable for vocals and field recordings that has a gimmicky effect
36	Lo-Fi	Creates lo-fi sound with a nostalgic feeling as if coming from a radio
37	Limiter	A limiter very effective on band rehearsals and live recording
38	BoostPls	Adds overall sound pressure during recording
39	All Comp	Compressor evens out volume differences between instruments in a band performance, for example
40-49	Empty	

8x COMP EQ algorithm				
No.	Patch name	Description	Recommended inputs 1 - 8	
0	VocIBand	General purpose patch for vocal band	1	Guitar amp
			2	Bass amp
			3	Vocal
			4	Chorus
			5-6	Drums
1	Inst	For jazz fusion bands	7-8	Keyboard
			1-2	Guitar amp
			3	Bass amp
			4	Piano
			5-6	Drums
2	AcoBand	For acoustic bands	7-8	Keyboard
			1	Acoustic bass
			2	Piano
			3	Vocal
			4	Chorus
			5-6	Acoustic guitar
			7-8	Percussion

Effect patch list 5

3	1ManBand	For self-production	1-2	Guitar
			3	Bass
			4	Keyboard
			5	Vocal
			6	Chorus
			7-8	Sequencer
4	StdDrum	Standard sounds for recording each drum in a kit	1	Bass drum
			2	Snare drum
5	VtgDrum	1970s drum sound with enhanced hi-hat	3	Hi-hat
			4	High tom
6	EhcdDrum	Punchy compressed drum sound	5	Mid tom
			6	Low tom
			7-8	Overhead mics
7	Percus	Suitable for recording individual percussion sounds	1-2	Small percussion
			3-4	Cymbals/bells
			5-6	Drums
			7-8	All percussion together
8	CompLtr	Versatile, mellow sound	1-8	
9	A Capla	For a cappella groups	1-2	Female vocals
			3-4	Male vocals
			5-6	Vocal duo
			7-8	All vocals together
10-19	Empty			

Mastering algorithm

No.	Patch name	Description
0	PlusAlfa	Enhances the overall power
1	All-Pops	Conventional mastering
2	StWide	Wide-range mastering
3	DiscoMst	For club sound
4	Boost	For hi-fi finish
5	Power	For a powerful low range
6	Live	Adds a live feel
7	WarmMst	Adds a warm feeling
8	TightUp	Adds a tight feeling
9	1930Mst	Mastering with 1930's sound
10	LoFi Mst	Lo-fi mastering
11	BGM	Mastering for background music
12	RockShow	Gives a rock style mix a live feel
13	Exciter	Lo-fi mastering with slight distortion in mid and upper range
14	Clarify	Emphasizes high-end range
15	VocalMax	Brings buried vocals to the foreground
16	RaveRez	Special sweep effect using sharp filter
17	FullComp	Strong compression over full frequency range
18	ClearPWR	Power tuning emphasizes midrange and adds sound pressure and clarity
19	ClearDMS	Enhances clarity and spaciousness
20	Maximizr	Boosts overall sound pressure level
21-29	Empty	

Effect patch list 6

Send-return effects

REVERB		
No.	Patch name	Description
0	TightHal	Hall reverb with a hard tonal quality
1	BrgtRoom	Room reverb with a hard tonal quality
2	SoftHall	Hall reverb with a mild tonal quality
3	LargeHal	Simulates the reverberation of a large hall
4	SmallHal	Simulates the reverberation of a small hall
5	LiveHous	Simulates the reverberation of a club
6	TrStudio	Simulates the reverberation of a rehearsal studio
7	DarkRoom	Room reverb with a gentle tonal quality
8	VcxRev	Tuned to enhance vocals
9	Tunnel	Simulates the reverberation of a tunnel
10	BigRoom	Simulates the reverberation of a gym-sized room
11	PowerSt.	Gate reverb
12	BrittHall	Simulates the bright reverb of a concert hall
13	BudoKan	Simulates the reverberation at the Budokan in Tokyo
14	Ballade	For slow ballads
15	SecBrass	Reverb for brass section
16	ShortPla	Short reverb
17	RealPlat	Spring reverb simulation
18	Dome	Reverb simulates playing in a domed-stadium
19	VinSprin	Simulates analog spring reverb
20	ClearSpr	Clear reverb with short reverb time
21	Dokan	Simulates the reverberation of a clay pipe
22-29	Empty	

CHORUS/DELAY		
No.	Patch name	Description
0	ShortDLY	Standard short delay
1	GtChorus	Chorus to enhance weak guitar sound
2	Doubling	Versatile doubling
3	Echo	Showy analog-style delay
4	Delay3/4	Dotted-8th-note delay in sync with tempo
5	Delay3/2	Dotted-quarter-note delay in sync with tempo
6	FastCho	Fast-rate chorus
7	DeepCho	Versatile deep chorus
8	Vocal	Chorus that enhances vocals
9	DeepDBL	Deep doubling
10	SoloLead	Keeps fast phrases tight
11	WarmyDly	Simulates warm analog delay
12	EnhanCho	Enhancer that uses phase-shifted doubling
13	Detune	For instruments with strong harmonics such as a digital electronic piano or synthesizer
14	Natural	Chorus with low modulation suitable for backing parts
15	Whole	Whole-note delay in sync with tempo
16	Delay2/3	Half-triplet-note delay in sync with tempo
17	Delay1/4	16th-note delay in sync with tempo
18-29	Empty	

Error message list

If you see a message like “---Error” push the **EXIT** key. When other errors and messages occur, the displayed screen will automatically close in three seconds.

Message	Meaning	Response
Messages that indicate something is missing		
No Card	There is no card inserted.	Make sure that an SD card is inserted correctly.
No Project	There is no project.	Check that the project has not been deleted or moved to a different place.
No File	There is no file in the project.	Check that the file has not been deleted or stored in a different place.
No USB Device	There is no USB connection.	The connection may have been canceled or there may be a problem with the cable.
Messages that are shown frequently		
Reset DATE/TIME	Setting lost because the batteries died.	Set the DATE/TIME again. → P14
Low Battery!	Time to change the batteries.	Change batteries or connect the adapter.
Stop Recorder	The function you tried cannot be accessed during playback/recording.	Stop the recorder first, and then try again..
Messages that indicate the object is protected		
Card Protected	The SD card is protected.	Eject the SD card, unlock its write-protection and then insert it again. → P12
Project Protected	The project is protected.	Disable using the PROTECT menu. → P89
File Protected	This file is read-only, so you cannot write to it.	Disable the read-only status of the file using a computer, for example.
Messages that indicate the capacity or structural limit has been exceeded		
Card Full	The card is full.	Change to a new card or delete unneeded data.
Project Full	No more projects can be saved on the card.	Delete unneeded projects.
File Full	The maximum number of files has been exceeded.	Delete unneeded files.
USB Device Full	The connected USB device is full.	Change the connected USB device or delete data.
Messages that indicate access failure		
Card Access Error	Unable to read or write to the card.	Press EXIT and try the operation again.
Project Access Error	Unable to read or write to the project.	Press EXIT and try the operation again.
File Access Error	Unable to read or write to the file.	Press EXIT and try the operation again.
USB Device Access Error	Unable to read or write to the connected USB device.	Press EXIT and try the operation again.
Card Format Error	This card is not in a format the unit can use.	Change the card format to one that the unit can use.
File Format Error	This file is not in a format the unit can use.	Change the file format to one that the unit can use.
USB Device Format Error	This USB device is not in a format the unit can use.	Change the USB format to one that the unit can use.
Other error messages		
Card Error	An error of some kind is occurring.	Press EXIT and try the operation again.
Project Error		
File Error		
USB Device Error		

Specifications

Section		R24	
Recorder	Track count	24 (mono)	
	Maximum number of simultaneous recording tracks	8	
	Maximum number of simultaneous playback tracks	24 audio +metronome	
	Recording data format	44.1/48 kHz, 16/24bit WAV format	
	Maximum recording time	200 minutes/1 GB (44.1 kHz 16-bit, mono tracks)	
	Projects	1000	
	Markers	100/project	
	Locator	Hours/minutes/seconds/milliseconds and bars/beats/ticks	
	File editing	Divide, trimming	
Other functions	Punch-in/out (manual, auto), bounce, A-B repeat, undo/redo		
Audio Interface	Number of recording channels	8	
	Number of playback channels	2	
	Quantization bit-rate	24	
	Sampling frequency	44.1, 48, 88.2, 96 kHz	
Mixer	Faders	9 (mono x 8, master x 1)	
	Level meter display	4-segment display	
	Track parameters	3-band equalizer, pan (balance), effect send x 2, invert	
	Stereo link	Tracks 1/2~23/24 selectable in pairs	
Effect	Algorithms	9 (CLEAN, DISTORTION, ACO/BASS, BASS, MIC, DUAL MIC, STEREO, 8xCOMP EQ, MASTERING)	
	Patches	330 insert, 60 send-return	
	Effect Modules	7 insert, 2 send	
	Tuner	Chromatic, guitar, bass, open A/D/E/G, D modal	
Rhythm	Voices	8	
	Sound format	16-bit linear PCM	
	Drum kits	10	
	Pads	8 (velocity-sensitive)	
	Precision	48 PPQN	
	Rhythm patterns	511/project	
Tempo		40.0~250.0 BPM	
Sampler	Playback formats	44.1/48 kHz, 16/24-bit WAV format	
	Editing functions	Trim, time-stretch	
Hardware	Recording media	SD card (16MB-2GB), SDHC card (4-32GB)	
	Analog-digital conversion	96kHz 24bit delta-sigma ADC	
	Digital-analog conversion	96kHz 24bit delta-sigma DAC	
	Display	128 x 64 pixel LCD (with backlight)	
	Inputs	INPUT1~8	8 XLR/standard phone combo jacks Input impedance: (Balanced input) 1K Ω balanced (2 hot) (Unbalanced input) 50K Ω unbalanced 1 with Hi-Z, input impedance 1 M Ω (Hi-Z on) 6 with phantom power Input level: -50 dBm < continuous < +4 dBm
		Built-in mics	Omnidirectional condenser microphones Gain: -50dBm < continuous < +4dBm
	Phantom power	48 V, 24 V	
	Outputs	OUTPUT	TRS phone type (balanced)
		PHONES	Standard stereo phone jack 20 mW x 2 (32 Ω load)
	USB	USB2.0 Hi-Speed (operation as audio interface/control surface/card reader/USB storage)	
	Power	DC 5V 1A AC adapter (ZOOM AD-14) Six AA batteries (4.5-hour continuous operation time with backlight set to 15 seconds and phantom power off)	
	Dimensions	376 mm (W) x 237.1 mm (D) x 52.2 mm (H)	
	Weight	1.3 kg	

Troubleshooting

If you think there is a problem with the operation of the R24, check the following tips first.

Problems during playback

- ◆ **No sound, or sound is very weak**
 - Check the connections with the monitoring system and its volume settings.
 - Make sure that status indicators in the mixer section are lit green and that their faders are raised. If a track's indicator is not green, press its key repeatedly until it lights green.
 - Make sure that the [MASTER] status key is not lit and that the [MASTER] fader is raised.
- ◆ **Moving the fader does not affect the volume**
 - On channels for which stereo link is turned ON, the fader of the even-numbered channel will have no effect. Either turn stereo link OFF (→ P20), or use the fader of the odd-numbered channel in the pair.
- ◆ **No sound from the input signal, or the sound is very weak**
 - Make sure that the **GAIN** control for that input is turned up.
 - Check that the status light is green (playback enabled) and that the fader of the track is raised.
- ◆ **An operation does not work and the message "Stop Recorder" is shown on the display**
 - Some operations are not possible while the recorder is operating. Press the **STOP** key to stop the recorder and then conduct the operation.

Problems during recording

- ◆ **Cannot record on a track**
 - Make sure that you have selected and enabled a recordable track.
 - Check whether you have run out of free space on the SD card (→ P102).
 - Recording is not possible if the project is protected. Either set "PROTECT" to "OFF" (→ P87), or use a different project.
- ◆ **The recorded sound is distorted**
 - Make sure that the **GAIN** knobs (input sensitivity) and recording levels are not set too high.
 - Lower the faders so that the 0 (dB) indicators of their level meters do not light.
 - If the EQ gain of the track mixer is set extremely high, the sound may be audibly distorted even if the fader is lowered. Lower the EQ gain to a more

suitable value.

- If an insert effect is applied to an input, check whether the effect output level (patch level) setting is suitable.

Problems with effects



- ◆ **Insert effect cannot be inserted**
 - If using the 8xCOMP EQ algorithm, the selection of insert points is limited (→ P81).
- ◆ **Insert effect is not working**
 - Check that the insert effect icon is shown on the display. If it is not shown, press the **EFFECT** key, then press the **INSERT** soft key and set ON/OFF to On.
 - Make sure that the insert effect is inserted in the desired location (→ P81)
- ◆ **Send-return effect is not working**
 - Confirm that the REVERB or CHORUS icon is shown on the display. If it is not shown, press the **EFFECT** key, then press the **REVERB** or **CHORUS** soft key and set ON/OFF to On.
 - Make sure that the send levels for the tracks are raised (→ P40, 80).

Other problems

- ◆ **Cannot save a project**
 - The project cannot be saved if the project is protected. Set "PROTECT" to "OFF" (→ P89).
- ◆ **Cannot create a new project or copy a project**
 - If "Project Full" appears on the display, no more projects can be created on the card. Delete unneeded projects to free up memory.
- ◆ **An error message is shown when attempting to execute a command**
 - Please check the error message list (→ P132).

Upgrading the firmware

Upgrade the firmware as necessary.

- 1 Copy the firmware upgrade file to the root directory of an SD card.
- 2 Insert the SD card with the firmware upgrade software file into the R24 (if it is not already in the unit).
- 3 While pressing and holding , turn the POWER switch ON.
The upgrade screen opens.
- 4 Select "OK" and press  to start upgrading.
- 5 When the screen shows that upgrading has completed, turn the R24 power OFF once and then turn it on again.

NOTE

- Download the latest system software at the ZOOM website (<http://www.zoom.co.jp>).
- Use the TOOL>SYSTEM>VERSION menu item to check the version of the system software that the unit is currently using.

Index

A

- A-B repeat function 32
 - A point 32
 - B point 32
- Algorithms 77
- Audio
 - Changing tempo without changing pitch . . . 61
 - Trimming unnecessary parts 63
- Audio interface 110, PDF
- Auto punch-in/out 29

B

- Bit rate setting 99
- Bouncing 43-44
- BPM setting 60
- Built-in mics 11, 19

C

- Changing names 73, 84, 94
- Chromatic tuner 35
- Connecting equipment 11, 18, 19
- Contrast 100
- Control surface 110, PDF

D

- Date and time setting 14
- Deleting data
 - Files 95
 - Marks 34
 - Projects 95
 - SD cards 102
- Display
 - Backlight 100
 - Contrast 100
 - Information 16

E

- Effects
 - Effect modules 77-78, 83, 115-125
 - Effect parameters 77, 84, 115-125
 - Effect types 77-79, 115-, 126-
 - Insert effects 45, 77-87
 - Mastering effects 45
 - Patches 126-131
 - Send-return effects 40, 77-79, 83-86
- EQ 40

F

- Fade in/out 64
- Files
 - Assigning to tracks 49
 - Changing file names 94
 - Copying 93
 - Deleting 95
 - Information 92
 - Selecting 91

G

- Gain 23
- Global quantization 52

H

- Hi-Z 10-11, 18

I

- Importing
 - Card reader 106
 - Files 106-108
 - Patches 86
 - Projects 17, 89-95, 97
 - USB memory 11, 107-109
- In points 29
- Input sensitivity 23
- Insert effects
 - Inserting before the MASTER fader 45
 - Insertion points 81
 - Using only for monitoring 87

L

- Level adjustment 23
- Locate function 33-34
- Loops 50

M

- Manual punch-in/out 30
- Marks 33
- Master tracks 46
- Mastering effect 45
- Metronome 36
- Mixing 39
- Mixing down to two tracks 43-46

- O**
- Out points 29
 - Overdubbing 27
- P**
- Pads 52, 67
 - Panning..... 40
 - Patches
 - Changing patch names 84
 - Editing 83
 - Initialization..... PDF
 - Importing 86
 - Patch list..... 126-131
 - Saving..... 85
 - Selection..... 80
 - Phantom power 11, 18, 104
 - Playlists..... 97-98
 - Power
 - Battery installation..... 13
 - Battery type setting..... 103
 - ON/OFF 14
 - Projects
 - Changing project names 94
 - Copying 93
 - Creating new 17, 90
 - Deleting 95
 - Overview..... 89
 - Protecting..... 89
 - Selecting..... 91
 - Sequential playback 97
 - Punching in and out 29-30
 - Auto punch-in/out 29
 - Manual punch-in/out 30
- Q**
- Quantization bit rate 99
- R**
- Recording
 - Additional tracks..... 27
 - Changing playback takes..... 25
 - First track 23
 - Formats..... 90, 99
 - Master track 46
 - Overdubbing..... 27
 - Preparations 17-19
- Rhythm functions 65-76
- Rhythm patterns
- Changing rhythm pattern names 73
 - Copying 71
 - Deleting 72
 - Creating 68
 - Importing 74
 - Assigning to tracks..... 22, 76
- S**
- Sampler functions 47-64
 - SD cards
 - Card reader functions..... 106
 - Changing while the power is on 101
 - Checking card capacities..... 102
 - Formatting 102
 - Installation..... 12
 - Send-return effects
 - Send level track settings..... 40
 - Patches..... 77, 83-86, 131
 - Sequence data 53-59
 - Creation 53
 - Editing 56
 - Playback..... 59
 - Sequential playback of projects..... 97
 - Shutting down 14
 - Specifications 133
 - Stereo link 20
 - Stereo settings 19-20
 - Swapping files..... 25
 - Switches 15, 18, 19
 - System version 103
- T**
- Tuner types and use 35
 - Tracks 20, 22-28, 31, 43-44, 49
 - Assigning 22, 25, 49, 76
 - Mixer 40, 41
 - Parameters 40, 41
- U**
- USB 105-111
 - Connecting with a computer..... 105
 - DAW software operation PDF
 - USB memory 107

FCC regulation warning (for U.S.A.)

This equipment has been tested and found to comply with the limits for a Class B digital device, pursuant to Part 15 of the FCC Rules. These limits are designed to provide reasonable protection against harmful interference in a residential installation. This equipment generates, uses, and can radiate radio frequency energy and, if not installed and used in accordance with the instructions, may cause harmful interference to radio communications. However, there is no guarantee that interference will not occur in a particular installation. If this equipment does cause harmful interference to radio or television reception, which can be determined by turning the equipment off and on, the user is encouraged to try to correct the interference by one or more of the following measures:

- Reorient or relocate the receiving antenna.
- Increase the separation between the equipment and receiver.
- Connect the equipment to an outlet on a circuit different from that to which the receiver is connected.
- Consult the dealer or an experienced radio/TV technician for help.

For EU Countries



Declaration of Conformity

zoom

4-4-3 Kandasurugadai, Chiyoda-ku, Tokyo 101-0062 Japan

Web site: <http://www.zoom.co.jp>