

ZOOM®

Q4n

Handy Video Recorder

User Guide

Safety and Operation
Precautions must be read
before using this unit.

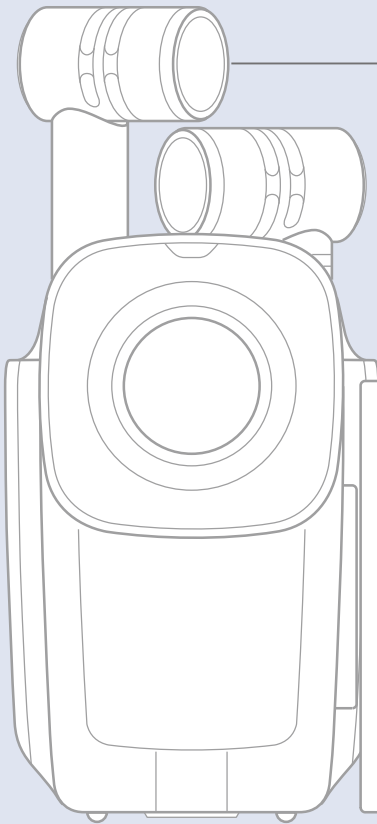

ZOOM
Handy Video Recorder

Q4n

© 2015 ZOOM CORPORATION

Copying or reproduction of this User
Guide in part or in whole without per-
mission is prohibited.

Contents

Parts and their functions	3	■ Auto Gain	24
■ Left side	3	Recording mode settings	25
■ Top	3	■ Setting the mode	25
■ Bottom	3	■ Mode explanations	25
■ Front	4	Camera settings	27
■ Back	4	■ Scene settings	27
■ Right side	4	■ Self timer	28
Mic overview	5	■ Upside Down	29
■ Mic features	5	File list	30
■ Using the X/Y mic technique	6	■ Opening the file list	30
■ Using the A/B mic technique	7	■ Playing files from the list	30
Operation of parts	8	Checking file information	31
■ Attaching the battery	8	Deleting recordings	32
■ Loading an SD card	8	Connections to the external input jack	33
■ Opening, closing and rotating the LCD screen	9	■ Using microphones that require plug-in power	33
Display overview	10	Headphones/line output and HDMI output	34
■ Main screen	10	■ Headphones/line output	34
■ Playback screen	11	■ HDMI output	34
■ Menu screen	12	USB connections	35
Charging the battery	13	■ Using USB connection functions	35
Turning the power on and off	14	■ Using as a card reader (computer/iPad)	36
■ Turning the power on	14	■ Using as a USB mic (computer/iPad)	36
■ Turning the power off	14	■ Using as a web camera (computer) ...	37
Setting the date and time	15	Locking the LCD rotation	38
Formatting SD cards	16	System settings	39
Adjusting recording levels	17	Updating the firmware	40
■ Adjusting recording levels manually ...	17	Troubleshooting	41
Adjusting the angle of view	18	Specifications	42
Recording	19	Safety Precautions	43
Audio monitoring settings	20	Usage Precautions	44
Playing recordings	21	Warnings and requests regarding safe battery use	45
■ Playing a file	21		
■ Changing the playback position	21		
■ Playing a different file	22		
Setting the sound	23		
■ Reducing noise (Lo Cut)	23		

Parts and their functions

Left side

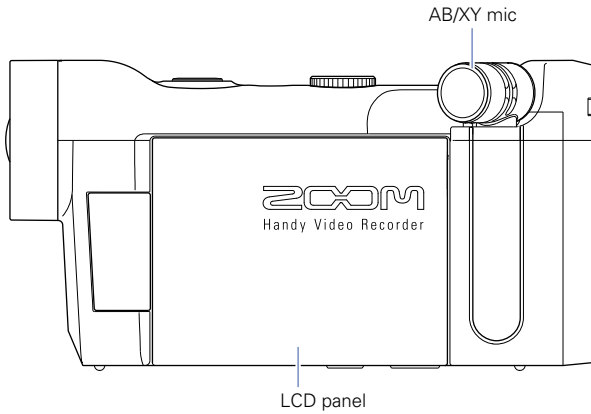

Top

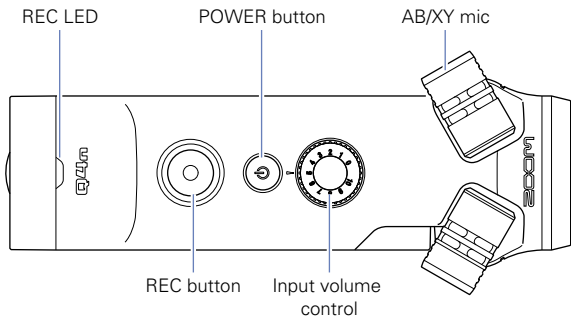

Bottom

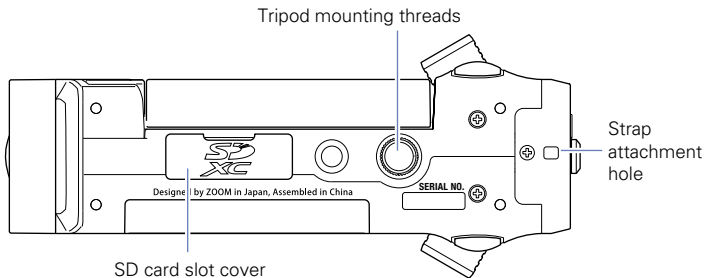

Parts and their functions (continued)

■ Front

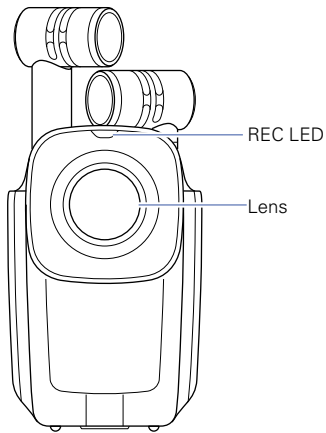

■ Back

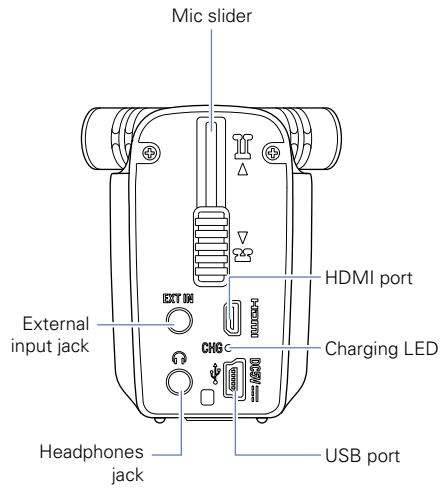

■ Right side

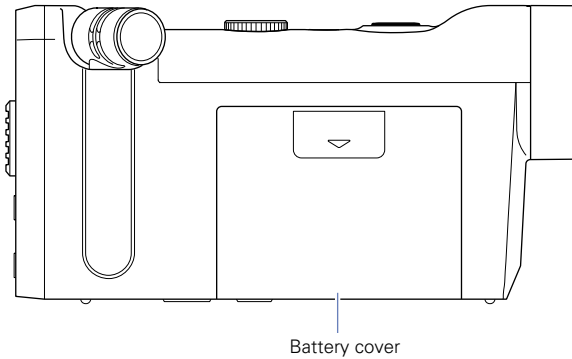

Mic overview

■ Mic features

The **Q4n** mic orientation can be changed, allowing the use of two stereo recording techniques with different characteristics.

X/Y technique

This technique uses two crossing directional mics.

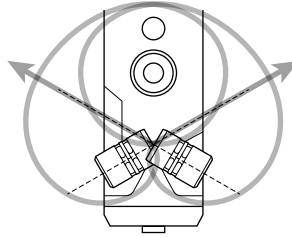

Features:

Providing a three-dimensional sound with natural depth and width, this is ideal when you want to capture a specific sound source that is nearby or at a medium distance, for example, solo performances, chamber music, live rehearsals and field recordings.

A/B technique

This technique uses two spread-apart directional mics.

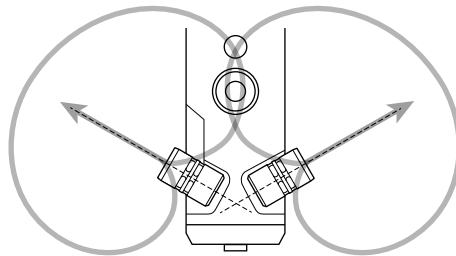

Features:

Providing a wide sense of stereo, in addition to recording the specific sound source, this technique is ideal for also capturing the sound of the surrounding environment.

This is useful when you also want to record the reverb of a hall, as well as for meetings or similar situations where you want to capture the sound of people talking in different areas of the room.

Mic overview (continued)

■ Using the X/Y mic technique

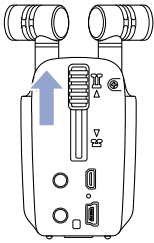

1. Slide the mic slider on the back up until it locks.
This raises the mics.

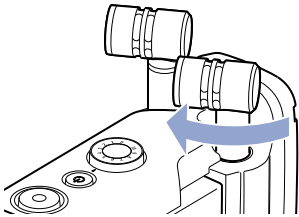

2. Rotate the left or right mic inward until it locks.
The mic locks when it clicks into place.

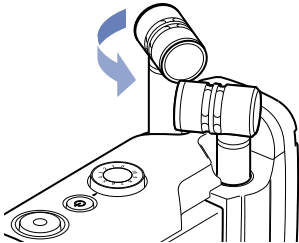

3. Rotate the other mic inward in the same way until it is fixed in place.

The X/Y technique will become active and the mic indicator on the LCD will change to XY.



CAUTION

Always use the mic slider to raise the mics. Moreover, do not use too much force when rotating the mics. Excessive force could damage the mics.

NOTE

- If the mics are not recognized as being in the X/Y position, they will be used as an A/B pair.
- When putting the mics away, rotate both outward before sliding the slider down.

Mic overview (continued)

■ Using the A/B mic technique

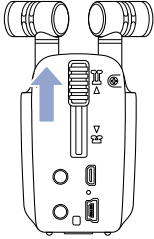

1. Slide the mic slider on the back up until it locks.

This raises the mics.

Operation of parts

■ Attaching the battery

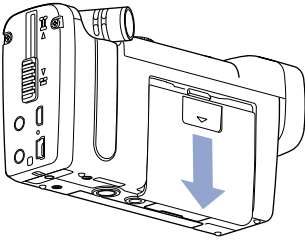

1. Slide the **Q4n** battery cover down to remove it.

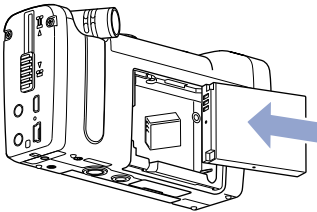

2. Install the battery in the direction of the arrow and re-attach the battery cover.

■ Loading an SD card

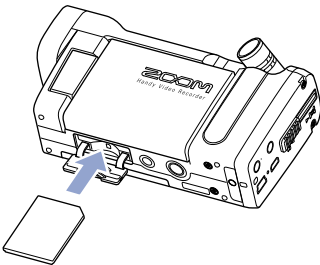

1. Open the SD card slot cover on the bottom of the **Q4n**.

2. Insert the SD card into the SD card slot.

To remove the card, push it further into the slot and then pull it out.

NOTE

- When inserting an SD card, be sure to insert the correct end with the top side up as shown.
- If an SD card is not loaded, recording and playback are not possible.
- To format an SD card, see P. 16.



CAUTION

Do not remove the SD card during recording. Doing so could damage the data.

Operation of parts (continued)

■ Opening, closing and rotating the LCD screen

Opening and closing the LCD

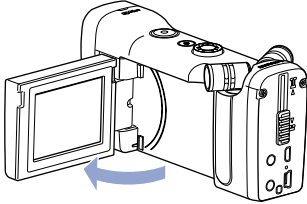

1. As shown in the illustration, open the LCD on the left side of the **Q4n**.

2. When not using the **Q4n**, close the LCD for storage.

Rotating the LCD

You can rotate the screen so you can check what is being recorded when filming yourself.

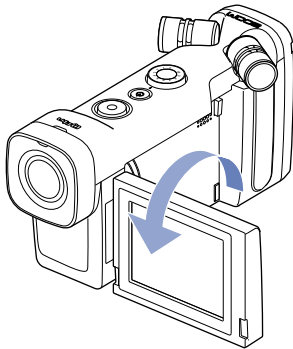

1. Rotate the screen in the direction of the arrow.

2. Rotate the screen in the opposite direction to return it to its original position.

NOTE

Recording is possible even when the LCD is closed.



CAUTION

Do not apply force in the direction opposite the rotation shown in the illustration. Doing so could damage the **Q4n**.

Display overview

■ Main screen

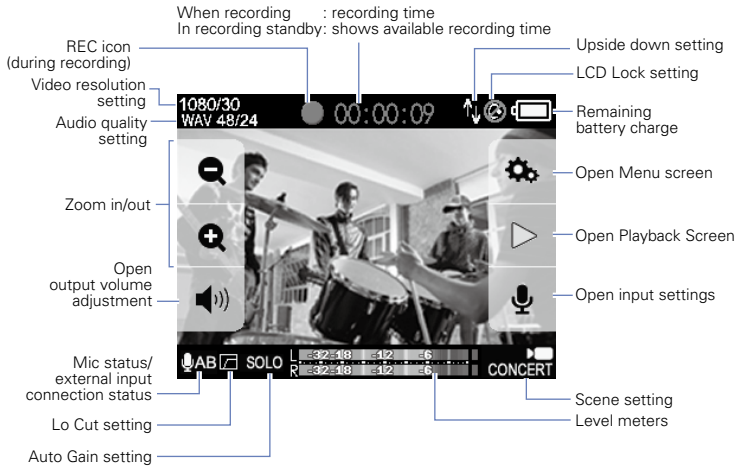

NOTE

The buttons will disappear if no operation occurs for some time. Touch the LCD to show the buttons again.

Display overview (continued)

■ Playback screen

During playback



When paused

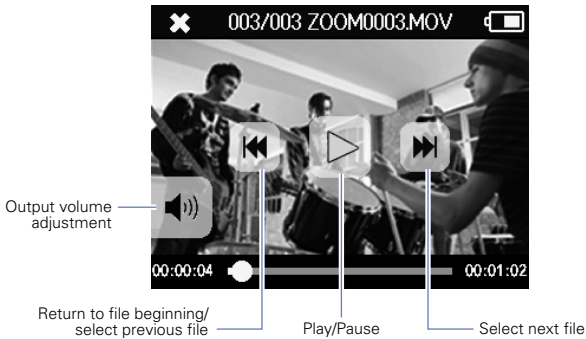

NOTE

The buttons will disappear if no operation occurs for some time. Touch the LCD to show the buttons again.

Display overview (continued)

■ Menu screen

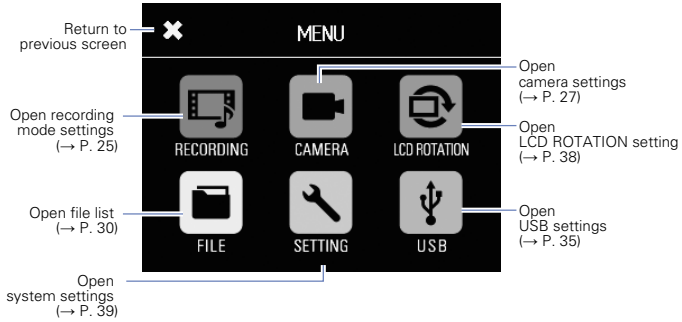

Using the menu



1. Touch the icon for the function you want to use.

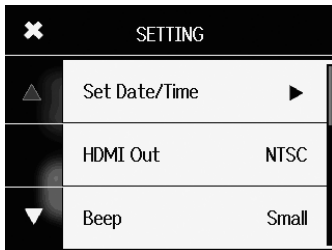

2. Select the item you want to set.

When settings have multiple pages, touch ▲ and ▼ to change pages.

If an item has a submenu, repeat these steps as necessary.

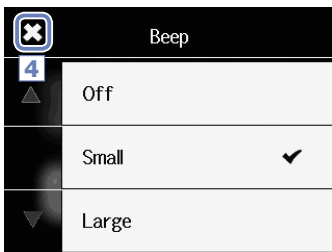

3. Make the change on the setting screen.

4. Touch X at the top left of the screen to return to the first screen.

Charging the battery

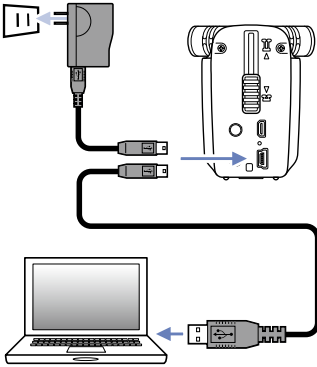

1. Turn the **Q4n** off.
2. Connect a USB power source (a running computer or ZOOM AD-17 AC adapter (sold separately)).

While the battery is recharging, the Charging LED on the back of the **Q4n** will stay lit.

3. After charging completes, disconnect the cable from the USB power source.

After charging has completed, the Charging LED will become unlit.

NOTE

Recharging the battery completely (100%) takes about 3 hours when connected to a computer and about 2 hours when using an AC adapter. (The amount of time required will vary depending on the conditions.)

CAUTION

- The battery will not charge while the recorder is on.
- The surrounding temperature should be between 5°C and 35°C (41°F and 95°F) when charging. At other temperatures, the battery could become hot, damaged or weakened.
- Do not leave the cable connected for long periods of time after charging completes.
- You must also follow the handling instructions in "Warnings and requests regarding safe battery use" on page 45.

Turning the power on and off

■ Turning the power on

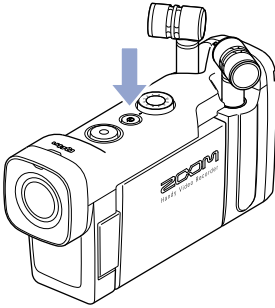

1. Press and hold  on the top.

The REC LED will light red and then green.

■ Turning the power off

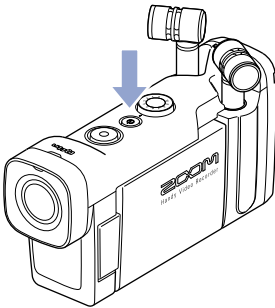



1. Press and hold  on the top.

After "Goodbye See You!" appears, the power turns off.

Setting the date and time

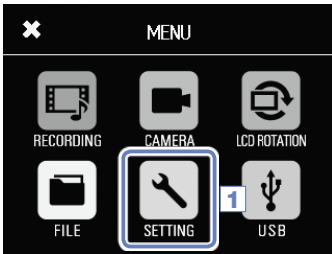
If the date and time are set, the recorder can add the recording date and time to files.



1. Touch  on the Menu screen.

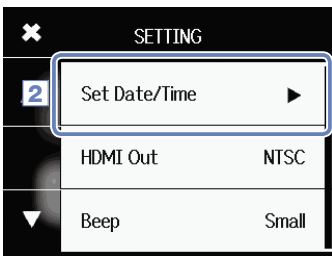

2. Touch Set Date/Time in the submenu.

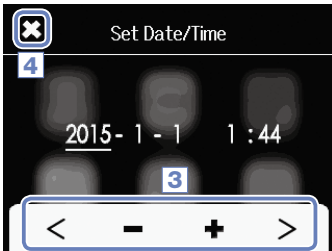

3. Touch < and > to select the item to change, and touch - and + to set the current date and time.

4. After completing the setting, touch  to close the menu.

Formatting SD cards

You should format SD cards for use with the **Q4n**.

1. Touch  on the Menu screen.

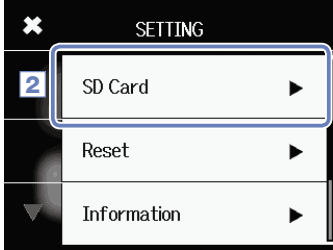

2. Touch SD Card in the submenu.

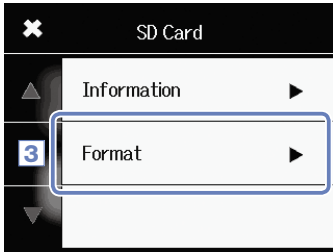

3. Touch Format in the submenu.

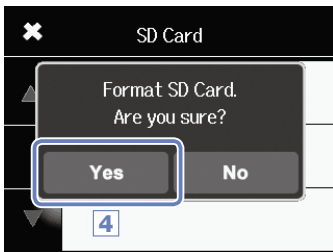

4. Touch Yes on the confirmation screen.

This will start SD card formatting. After it completes, "Done" will appear and the SD Card menu will reopen.

NOTE

- If the SD card's write-protection switch is ON, it cannot be formatted.
- Select Information to check the open space on the SD card.



CAUTION

- After purchasing a new SD card, always format it using the **Q4n** to maximize performance.
- All data previously saved on the SD card will be deleted when it is formatted.

Adjusting recording levels

■ Adjusting recording levels manually

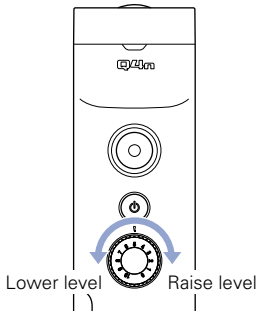

1. Turn  on the top.

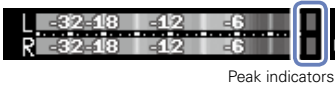

2. If the peak indicator lights, turn  to lower the level.

Adjust the level so that the peak indicator does not light even when loud sounds are input.

NOTE



- In addition to the peak indicators, the REC LED also blinks when loud sounds are input.
- Use Auto Gain to adjust the recording level automatically. (See page 24.)

Adjusting the angle of view

By changing the digital zoom magnification you can set the angle of view to one of five levels.



1. Touch  and  on the Main screen.

-  Narrow the angle of view.
This trims down to the central subject.
-  Widen the angle of view.
This records a wider range.

NOTE

The angle of view can be set to 0.75x, 0.85x, 1.00x, 1.30x or 1.50x.

Recording

Recording can be started by pushing one button when the Main screen is open.

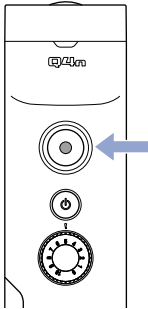

1. Press .

This starts video recording.
During video recording, the REC LED above the lens lights red.

2. Press  again to stop video recording.

NOTE

- If the transfer speed to the card is not fast enough during video recording, "Low Speed Card!" appears on the screen and recording might stop. To avoid this, we recommend using cards that are Class 10 or faster. Information about SD cards that can be used with this unit is provided at www.zoom.co.jp.
- Use the RECORDING MODE menu to make specific video recording settings. (See "Recording mode settings" on page 25.)

Audio monitoring settings

You can monitor audio being recorded with video through the headphones jack.

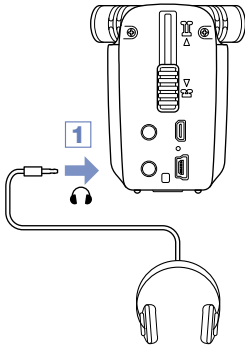



1. Connect headphones or other audio equipment to the headphones jack on the back of the **Q4n**.



2. To adjust the monitoring volume, touch  on the display.

The Volume pop-up appears on the screen.



3. Touch  and  or slide the bar on the pop-up to adjust the volume.

4. After completing the setting, touch  to close the Volume pop-up.

Playing recordings

■ Playing a file



1. Touch  on the Main screen.



2. Touch  to stop playback.

This reopens the Main screen.

■ Changing the playback position

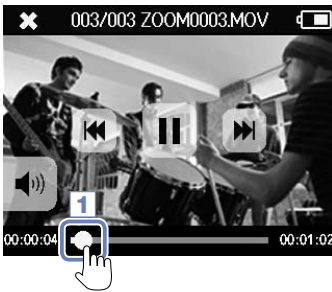

1. Touch the playback position bar.

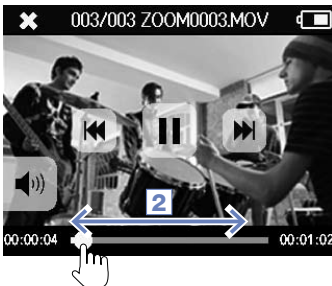

2. Slide it to the position you want.

3. Remove your finger from the screen.

Playback will start from that position.

Playing recordings (continued)

■ Playing a different file



1. To play the next file, touch the screen once and then touch .

To play the previous video, touch  twice.

NOTE

- Touch  during playback to return to the beginning of the currently selected file.
- The buttons will disappear if no operation occurs for some time. Touch the LCD to show the buttons again.
- The **Q4n** can only play videos that it recorded.
- By connecting an HDMI cable (sold separately) to the HDMI OUT, video can be output to an external device. (See "HDMI output" on page 34.)
- You can open a list of thumbnails to select a video for playback. (See "FILE list" on page 30.)
- Use QuickTime to play recorded videos on a computer. QuickTime can be downloaded from the Apple Inc. website.

Setting the sound

■ Reducing noise (Lo Cut)

You can use the low-cut filter to reduce the sound of wind, vocal pops and other noise.



1. Touch  on the Main screen.

This opens the INPUT SETTING screen.

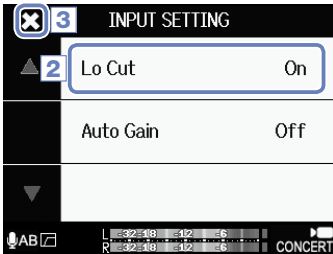

2. Touch Lo Cut on the INPUT SETTING screen, and change the setting.

Setting	Explanation
Off	This disables the lo-cut filter.
On	This enables the lo-cut filter.

3. After completing the setting, touch  to close the INPUT SETTING screen.

NOTE

When filming outdoors, attach the windscreen to reduce wind noise.

Setting the sound (continued)

Auto Gain

The **Q4n** can adjust recording levels automatically.



1. Touch  on the Main screen.

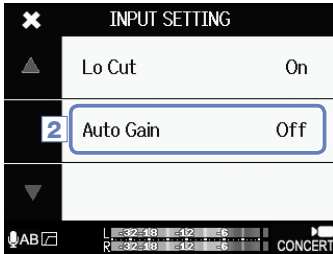

2. Touch Auto Gain on the INPUT SETTING screen, and change the setting.

When enabled, the **Q4n** will automatically adjust the gain for suitable recording levels.

Auto Gain: settings and main applications

Setting	Main applications
Off	This disables Auto Gain. Adjust the recording level manually.
Concert	This is suitable for recording band performances, concerts and other loud situations.
Solo	Use for solo performances and other quiet sounds.
Meeting	Use for meetings and field recordings.





CAUTION

When Auto Gain is enabled, the input volume control on the top of the **Q4n** has no effect.

Recording mode settings

Setting the mode

You can change the video recording mode, video recording frame rate, resolution and audio quality. Increasing the video and audio quality decreases the available recording time.

1. Touch  on the Menu screen.
2. Touch the item that you want to set in the submenu.
3. After completing the setting, touch  to close the submenu.

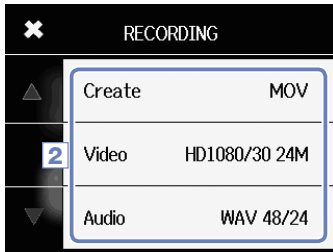

Mode explanations

RECORDING MODE

Create: type of files created

Setting	Explanation
MOV	Record MOV files containing both video and audio.
STEREO AUDIO	Save only audio as WAV or AAC files.

Video: video recording resolution and frame rate

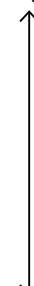
Setting	Resolution	Frames/second	Explanation	File size
3M HD/30 24Mbps	2304 × 1296	30	Record video with a resolution higher than Full HD. Use when you want to record at high resolution.	 Large Small
HD 1080/30 24Mbps	1920 × 1080	30	This is suitable for all kinds of video recording. Record video with Full HD resolution.	
HD 1080/30 16Mbps	1920 × 1080	30	Use when you want to record at Full HD resolution for a longer time.	
HD 720/60 15Mbps	1280 × 720	60	Use when you want to record subjects that move quickly.	
HD 720/30 8Mbps	1280 × 720	30	Use when you want to balance recording time and resolution.	
WVGA/60 8Mbps	800 × 480	60	Use when you want to record subjects that move quickly for a long time.	
WVGA/30 5Mbps	800 × 480	30	Use when you want to maximize recording time.	

NOTE

If PAL is selected for HDMI output, the frames/second options become 25 and 50. (See “System settings” on page 39.)

Recording mode settings (continued)



Audio: audio quality

Setting	Explanation	File size
WAV 96kHz/24bit	Record in an uncompressed WAV format when audio quality is important. The higher the sampling frequency (kHz) and bit rate, the better the audio quality.	Large ↑
WAV 96kHz/16bit		
WAV 48kHz/24bit		
WAV 48kHz/16bit		
WAV 44.1kHz/24bit		
WAV 44.1kHz/16bit		
AAC 320kbps	Record in a compressed AAC format when you need to save SD card space. The higher the bit rate (bps), the better the audio quality.	↓ Small
AAC 256kbps		
AAC 192kbps		
AAC 128kbps		
AAC 64kbps		

Camera settings

■ Scene settings

You can change the camera settings, including brightness and tone, according to the lighting conditions of the recording environment.

1. Touch  on the Menu screen.
2. Touch Scene in the submenu.
3. Touch the setting value in the submenu.
4. After completing the setting, touch  to close the submenu.

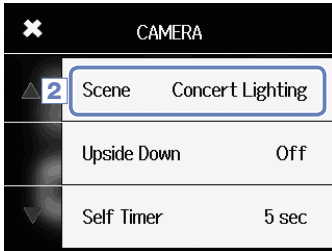



Scene: camera settings for recording scene conditions

Setting	Explanation
Auto	Adjustments are made without specific scene conditions.
Concert Lighting	Suitable adjustments are made for concert lighting conditions that are bright and change drastically.
Night	Adjustments are made for night and other dark situations.
Concert-Low Light	Suitable adjustments are made for small concert halls and other dim lighting conditions.
Dance Club	Suitable adjustments are made for dance clubs and other venues where the lighting changes drastically.
Jazz Club	Suitable adjustments are made for jazz clubs and similar venues.
Concert Hall	Suitable adjustments are made for classical concerts, recitals and similar performance conditions.
Rehearsal-Studio	Suitable adjustments are made for recording and rehearsal studio conditions.
Garage	Suitable adjustments are made for band performances in a garage.
Outdoor	Adjustments are optimized for outdoor recording.
Sunset	Adjustments are optimized for sunset scenes.

Camera settings (continued)

Self timer

This function starts video recording a set number of seconds after pressing .

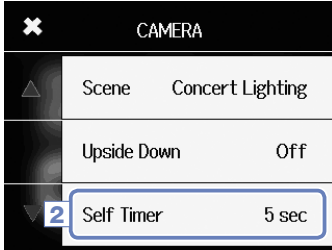

1. Touch  on the Menu screen.
2. Touch SelfTimer in the submenu.
3. Touch the setting value in the submenu.

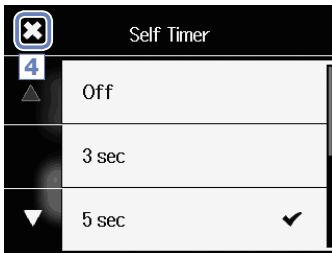

4. After completing the setting, touch  to close the submenu.



Self Timer: self timer settings

Setting	Explanation
Off	Self timer not used.
3 sec	Start recording 3 seconds after pressing  .
5 sec	Start recording 5 seconds after pressing  .
10 sec	Start recording 10 seconds after pressing  .

NOTE

The self timer can only be used when the LCD is rotated towards yourself. (See "Rotating the LCD" on page 9.)

Camera settings (continued)

Upside Down

Video will be saved with the image rotated 180°. Use when the **Q4n** is recording upside down, for example.

1. Touch  on the Menu screen.
2. Touch Upside Down in the submenu.
3. Touch the setting value in the submenu.

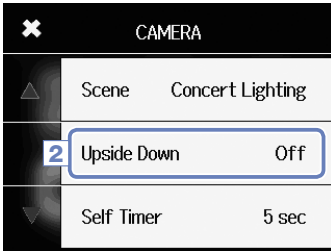

4. After completing the setting, touch  to close the submenu.

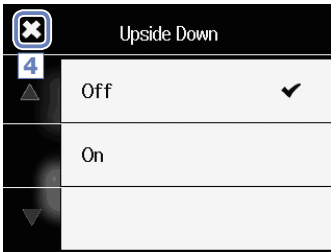

Upside Down: reverse vertical orientation when recording

Setting	Explanation
Off	Video is not rotated.
On	Video will be saved with the image rotated 180°.

File list

On this screen, you can view a list of video files and play them back.

■ Opening the file list



1. Touch  on the Menu screen.

This opens the FILE list screen.

If there are many files, touch < and > to change pages.

■ Playing files from the list



1. Touch the thumbnail for the file you want to play.

The touched file will start playing.



2. To stop playback, touch .

The FILE list screen reopens.

Checking file information

You can check information about recorded files.

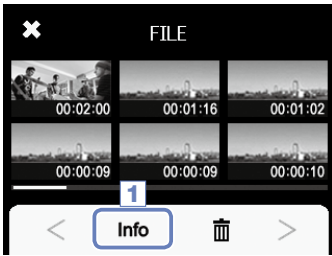

1. Touch **Info** on the FILE list screen.

The screen title will change to FILE INFORMATION.

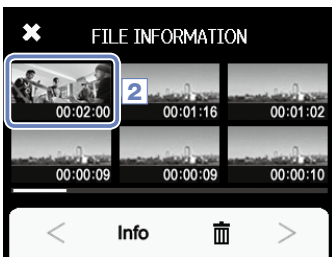

2. Touch a file to show its information.

Information about the selected file will appear.



3. After checking the information, touch **X** to close the pop-up.

Deleting recordings

You can delete files that you do not need.

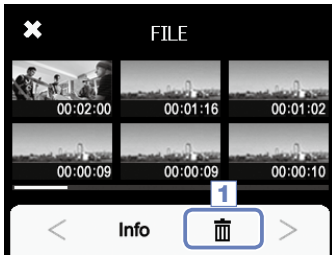

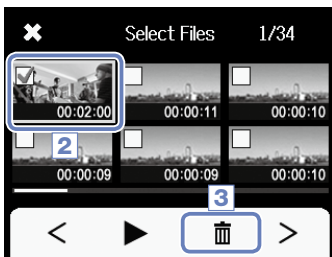

1. Touch  on the FILE list screen.

Checkboxes appear on the file thumbnails.



2. Touch a file to add a check to its box, marking it for deletion.

Touch  to play the last selected file, which is framed in green.

3. Touch .

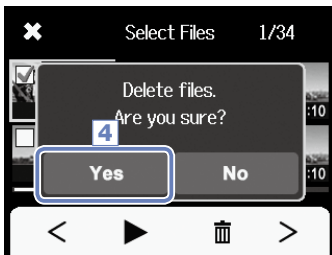

4. Touch Yes on the confirmation screen.

The selected file(s) will be deleted.
Touch No to cancel the operation.

Connections to the external input jack

You can capture audio with an external mic or audio device when recording video.

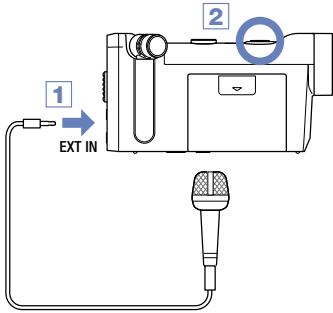

1. Connect the external mic or audio device to the **Q4n** external input jack.

2. Press

This starts recording.

■ Using microphones that require plug-in power

Enable plug-in power for mics that require it.

1. Connect the mic that requires plug-in power to the external input jack.

2. Touch  on the Main screen.

This opens the INPUT SETTING screen.



3. Touch Plug-in Power on the INPUT SETTING screen, and change the setting to On.

4. After completing the setting, touch  to close the INPUT SETTING screen.

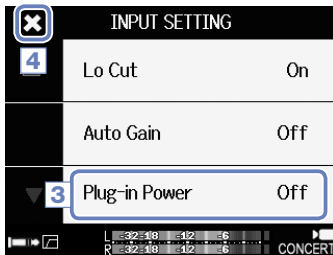

NOTE

- Plug-in Power will not appear when nothing is connected to the external input jack.
- The built-in mics are disabled when an external device is connected to the external input jack.

Headphones/line output and HDMI output

Headphones/line output

You can listen to the audio with headphones or an external audio amplifier.

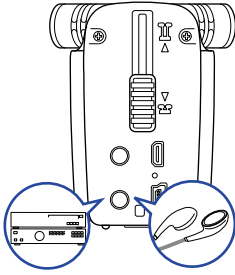

1. Connect headphones or audio equipment to the **Q4n** headphones jack using a stereo mini plug cable.
2. Start video playback on the **Q4n**.

HDMI output

Use an HDMI cable to show **Q4n** video recordings in high definition on an HDMI TV .

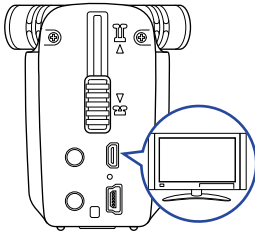

1. Connect the **Q4n** HDMI jack to a TV using an HDMI cable (sold separately).
2. Start video playback on the **Q4n**.

NOTE

Some TVs do not support some audio formats, so correct playback might not always be possible.

CAUTION

- The **Q4n** has an HDMI Type D Micro connector. Be sure to use a High Speed HDMI (category 2) cable that has an HDMI Type D Micro connector on one end to connect to the **Q4n** and a connector that matches the TV's HDMI input on the other end.
- Connecting or disconnecting an HDMI cable during recording will cause video and audio recording to stop.

USB connections

You can use the **Q4n** as a card reader or USB mic, as well as a web camera for streaming audio and video.

■ Using USB connection functions



1. Touch  on the Menu screen.

This opens the USB menu.

2. Touch the icon for the function you want to use.

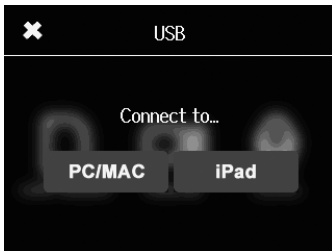

3. If you selected CARD READER or USB MIC, touch PC/MAC or iPad in the submenu to select the connected device.

4. Touch the function you want to use on the confirmation screen.

5. Use a USB cable to connect a computer or an iPad.

When the **Q4n** is recognized, it will be ready to use.

6. To end a USB connection, conduct the final operation for the function and then touch Yes on the confirmation screen.

This turns the **Q4n** power OFF.

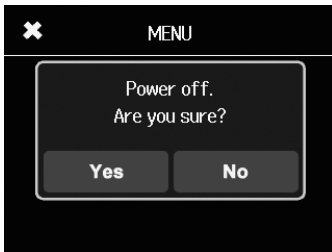

NOTE

- When connected to a computer, power can be supplied to the **Q4n** by USB. When connected to an iPad, power cannot be supplied to the **Q4n** by USB.
- An iPad Camera Connection Kit (sold separately) is necessary to connect an iPad.

USB connections (continued)

■ Using as a card reader (computer/iPad)

When connected to a computer or iPad, the **Q4n** can act as a removable disk, allowing the contents of the loaded SD card to be read.

1. On a file management screen of the computer or iPad, view the contents of the **Q4n**.
2. Work with the files on the SD card.
3. To end use, touch , and disconnect the USB cable.

If connected to an iPad, simply disconnect it.

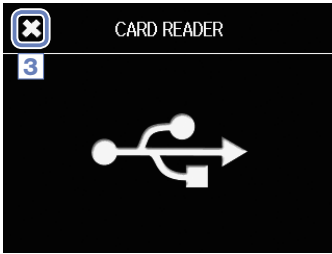

■ Using as a USB mic (computer/iPad)

The **Q4n** can be used as a USB mic to input sound to a computer or iPad.

1. Select the **Q4n** as the audio source in the computer or iPad application to use it as a mic.

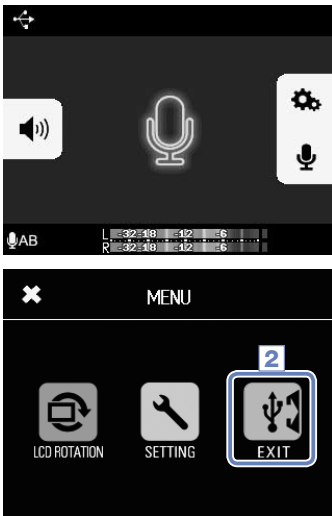

2. To end use, touch  on the menu screen, and disconnect the USB cable.

NOTE

- Refer to the manual for the computer or application that you are using for detailed operation procedures.
- Video recording is not possible during use as a USB mic.

USB connections (continued)

■ Using as a web camera (computer)

The **Q4n** can be used as a web camera to input audio and video to a computer.



1. Select the **Q4n** as the video source in the computer application to use it as a camera.

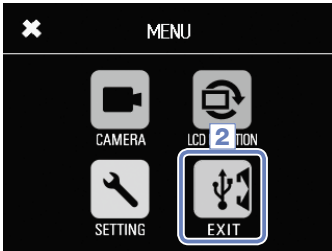



2. To end use, touch  on the menu screen, and disconnect the USB cable.

Delay setting

When using the **Q4n** as a web camera with a streaming application that does not have a lip synchronization function, you can set an audio delay time so that it matches the timing of the video.

1. Touch **DLY** on the screen.

2. In the submenu, touch  and  to adjust the audio delay time.

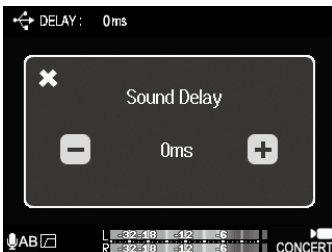



The delay time can be set from 0–1000 ms.

NOTE

- To use as a web camera, an audio driver must be downloaded from the ZOOM website (www.zoom.co.jp) and installed on the computer.
- The **Q4n** can simultaneously transmit video with resolutions up to HD720p and 48 kHz/16-bit PCM audio to a computer.
- Computer playback signals cannot be output from the **Q4n**.
- When being used as a web camera, the SETTING menu cannot be used.

Locking the LCD rotation

You can lock the rotation of the LCD screen.

1. Touch  on the Menu screen.
2. Touch the setting value in the submenu.
3. Touch  to return to the Menu screen.

This will close the submenu.

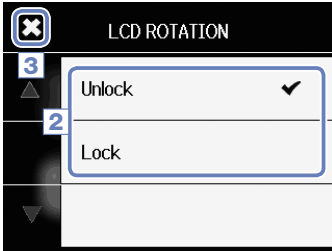



Setting	Explanation
Unlock	The screen rotates to match the LCD orientation.
Lock	The screen keeps the current state.

System settings

Make settings related to the **Q4n** system.

1. Touch  on the Menu screen.

2. Touch the item that you want to set in the submenu.

Touch  and  to change the display and show hidden items.

3. After completing the setting, touch .

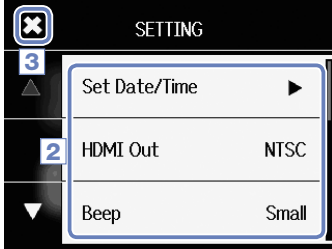

Setting	Explanation
Set Date/Time	Set the date and time of the internal clock. (See "Setting the date and time" on page 15)
HDMI Out	Set the format of the video output from the HDMI port. Select NTSC or PAL.
Beep	Set whether the recorder makes sounds when it is turned on or operated. Select Off, Small or Large.
Auto Power Off	Set to turn off automatically if not used for a certain amount of time. This setting has no effect during recording or when an AC adapter is connected. Select Off or 2, 5 or 10 minutes.
Play Mode	Set whether all files are played continuously or only the selected file is played. Select Play One or Play All.
Playback Lvl Meter	Set whether or not level meters are shown on the playback screen.
SD Card	Check the amount of open space on the SD card or format the card. (See "Formatting SD cards" on page 16.)
Reset	Restore the Q4n to its factory default settings.
Information	View the Q4n firmware version.
Direct Monitor	Set whether the input sound is monitored directly when used as a USB mic. This can only be selected during use as a USB mic.

Updating the firmware

The **Q4n** firmware can be updated to the latest version.

1. Copy the file for updating the firmware to the root directory on the SD card.

The latest version of the firmware can be downloaded from www.zoom.co.jp.

2. Insert the SD card into the **Q4n**'s card slot.

3. While pressing and holding , press  to start the unit.

Keep pressing the buttons until the firmware update screen opens.

4. Touch Yes.

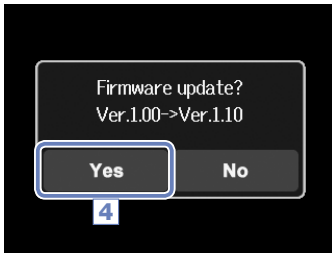

5. When updating completes, press  for at least one second to shut down.



CAUTION

Upgrading the firmware is not possible if the remaining battery power is low.

NOTE

You can check the current firmware version with the Information function in the SETTING menu. (See "System settings" on page 39.)



Troubleshooting

If you think that the **Q4n** is operating incorrectly, check the following items first.

Recording/playback trouble

◆ There is no sound or output is very quiet

- Check the connections to your monitoring system and its volume setting.
- Confirm that the volume of the **Q4n** is not too low.

◆ The recorded sound cannot be heard or is very quiet

- Confirm that the mic is oriented correctly.
- Check the input level settings (→ P.17).
- If a music player or other device is connected to the external input jack, raise the output level of that device.

◆ The stereo seems unnatural in the recorded sound

- Confirm that the mic is completely set in the X/Y or A/B position (→ P. 6-7).

◆ Recording audio/video is not possible

- Confirm that the SD card has open space. (→ P.16)

Specifications

Recording media	SD/SDHC/SDXC cards (Class 10 or higher, up to 128 GB)
Image sensor	1/3-inch 3-megapixel CMOS sensor
Lens	Fixed focus (36 cm – ∞), F2.0, focal distance about 16.6 mm (35 mm equivalent), 160° FOV
Video format	MPEG-4 AVC/H.264 (MOV)
Video resolutions	3M HD (2304×1296) 30 fps, HD1080p 30 fps, HD720p 60 fps, HD720p 30 fps, WVGA 60 fps, WVGA 30 fps
Audio formats	WAV (16/24-bit quantization, 44.1/48/96 kHz sampling frequency) AAC (64–320 kbps bit rate, 48 kHz sampling frequency)
Audio functions	Lo Cut filter, Auto Gain
Image functions	Digital zoom (×0.75/×0.85/×1.00/×1.30/×1.50), scene selection (Auto/Concert Lighting/Night/Concert-Low Light/Dance Club/Jazz Club/Concert Hall/Rehearsal-Studio/Garage/Outdoor/Sunset) Self timer (Off/3 sec/5 sec/10 sec)
Display	2.0" full-color touchscreen LCD
L/R inputs	Mic
	120° AB/120° XY stereo formats Maximum sound pressure input: 140 dB SPL Input gain: -30 to +44 dB
	EXT-IN
	Input connector: stereo mini jack Input gain: -∞ to +26 dB Input impedance: 2 kΩ or more Supports plug-in power
Output connectors	Combined line/headphones stereo mini jack HDMI micro Type D
Built-in speaker	400 mW 8 Ω mono speaker
USB	Mini B type <u>Operation as mass storage</u> Class: USB 2.0 High Speed <u>Operation as audio interface</u> Class: USB 2.0 Full Speed Specifications: 44.1 kHz sampling rate, 16-bit <u>Operation as webcam</u> Specifications: WVGA/720p video, 48 kHz 16-bit audio Note: Audio interface and mass storage operation with iPad is supported. Note: USB bus power supported
Power supply	Lithium-ion battery: DC 4.2 V maximum voltage, DC 3.7 V nominal voltage, 1,050 mAh capacity AC adapter (ZOOM AD-17, sold separately): DC 5 V/1 A
Recharging times	By USB: about 3 hours Using ZOOM AD-17: about 2 hours
Battery operation time	Rated: about 3 hours or more (when recording 720p/30 fps video with LCD closed)
External dimensions	Main unit (maximum dimensions when mic stored): 119 (length) × 51 (width) × 62 (height) mm Main unit (maximum dimensions when mic extended): 119 (length) × 39 (width) × 86 (height) mm
Included accessories	User guide (this document), LCD unit, Lithium-ion battery (1050 mAh BT-02), 1.5 m USB cable, windscreen (sponge), accessory mount adapter, lens cover, lens hood, strap

Safety Precautions

In this User Guide, symbols are used to highlight warnings and cautions that you must read to prevent accidents. The meanings of these symbols are as follows.



Something that could cause serious injury or death.



Something that could cause injury or damage to the equipment.

Other symbols used



An action that is mandatory.



An action that is prohibited.

WARNING

■ Operation using an AC adapter

- ⓘ Never use any AC adapter other than a ZOOM AD-17 (sold separately).
- ⊘ Do not do anything that could exceed the ratings of outlets and other electrical wiring equipment.

■ Alterations

- ⊘ Do not open the case or modify the product.

CAUTION

■ Product handling

- ⓘ Do not drop, bump or apply excessive force to the unit.
- ⓘ Be careful not to allow foreign objects or liquids to enter the unit.

■ Operating environment

- ⊘ Do not use in extremely high or low temperatures.
- ⊘ Do not use near heaters, stoves and other heat sources.
- ⊘ Do not use in very high humidity or where it could be splashed by water.
- ⊘ Do not use in places with frequent vibrations.

■ AC adapter handling

- ⓘ When disconnecting the power plug, always pull on the plug itself, not the cable.
- ⓘ When not using the unit for extended periods, disconnect the power plug from the outlet.

■ Volume

- ⊘ Do not use at a loud volume for long periods of time.

You might need this User Guide in the future. Always keep it in a place where you can access it easily.

Usage Precautions

■ Interference with other electrical equipment

In consideration of safety, the **Q4n** has been designed to minimize its emission of electromagnetic waves and to suppress interference from external electromagnetic waves. However, equipment that is very susceptible to interference or that emits powerful electromagnetic waves could result in interference if placed nearby. If this occurs, place the **Q4n** and the other device farther apart.

With any type of electronic device that uses digital control, including the **Q4n**, electromagnetic interference could cause malfunction, corrupt or destroy data and result in other unexpected trouble. Always use caution.

■ Cleaning

Use a soft cloth to clean the exterior of the unit if it becomes dirty. If necessary, use a damp cloth that has been wrung out well to wipe it.

Never use abrasive cleansers, wax or solvents such as alcohol, benzene or paint thinner.

■ Breakdown and malfunction

If the unit becomes broken or malfunctions, immediately disconnect the AC adapter, turn the power off and disconnect other cables. Contact the store where you bought the unit or ZOOM service with the following information: product model, serial number and specific symptoms of breakdown or malfunction, along with your name, address and telephone number.

■ Copyrights



Windows is a trademark of Microsoft Corporation (USA). Apple, Macintosh, iPad, QuickTime and the QuickTime logo are registered trademarks or trademarks of Apple Inc. in the USA and other countries. The SD, SDHC and SDXC logos are trademarks. HDMI (High-Definition Multimedia Interface) and **HDMI** are trademarks of HDMI Licensing, LLC. Other product names, registered trademarks and company names in this document are the property of their respective companies.

Recording from copyrighted sources, including CDs, records, tapes, live performances, video works and broadcasts, without permission of the copyright holder for any purpose other than personal use is prohibited by law. Zoom Corporation will not assume any responsibility related to infringements of copyrights.

Warnings and requests regarding safe battery use

Carefully read the following warnings in order to avoid serious injuries, burns, fires and other problems caused by leaking, heat generation, combustion, rupture or accidental swallowing.

DANGER

- ⊘ Do not charge the Zoom BT-02 lithium-ion battery in any other than by using a **Q4n** in combination with either a Zoom AD-17 AC adapter (sold separately) or USB port, or by using a Zoom LBC-1 lithium battery charger (sold separately).
- ⊘ Do not disassemble the battery, put it in fire, or heat it in a microwave or conventional oven.
- ⊘ Do not leave the battery near a fire, in strong sunlight, inside a vehicle that has become hot or in similar conditions. Do not recharge in conditions like these.
- ⊘ Do not carry or store the battery with coins, hairpins or other metal objects.
- ⊘ Do not allow the battery to come in contact with any liquid, including water, seawater, milk, soft drinks or soapy water. Do not charge or use a battery that is wet.

CAUTION

- ⊘ Do not hit the battery with a hammer or other object. Do not step on it or drop it. Do not otherwise impact or apply force to the battery.
- ⊘ Do not use the battery if it becomes deformed or damaged.
- ⊘ Do not remove or damage the outer seal. Never use a battery that has had all or part of its outer seal removed or a battery that has been torn.

Please recycle batteries to help conserve resources. When discarding used batteries, always cover their terminals and follow all laws and regulations that are applicable to the location.

The contents of this document and the specifications of the product may be changed without notice.

FCC regulation warning (for U.S.A.)

This equipment has been tested and found to comply with the limits for a Class B digital device, pursuant to part 15 of the FCC Rules. These limits are designed to provide reasonable protection against harmful interference in a residential installation. This equipment generates, uses and can radiate radio frequency energy and, if not installed and used in accordance with the instructions, may cause harmful interference to radio communications. However, there is no guarantee that interference will not occur in a particular installation. If this equipment does cause harmful interference to radio or television reception, which can be determined by turning the equipment off and on, the user is encouraged to try to correct the interference by one or more of the following measures:

- Reorient or relocate the receiving antenna.
- Increase the separation between the equipment and receiver.
- Connect the equipment into an outlet on a circuit different from that to which the receiver is connected.
- Consult the dealer or an experienced radio/ TV technician for help.

For EU Countries



Declaration of Conformity



Disposal of Old Electrical & Electronic Equipment (Applicable in European countries with separate collection systems)

Products and batteries that have been marked with the symbol of a crossed-out wheeled waste bin must not be disposed of with household waste.

Old electrical/electronic equipment and batteries should be recycled at facilities that are able to process them and their byproducts.

Contact the local government for information about nearby recycling facilities. Conducting recycling and waste disposal properly helps conserve resources and prevents harmful impacts on human health and the environment.



THIS PRODUCT IS LICENSED UNDER THE AVC PATENT PORTFOLIO LICENSE FOR THE PERSONAL AND NONCOMMERCIAL USE OF A CONSUMER TO

- ENCODE VIDEO IN COMPLIANCE WITH THE AVC STANDARD ("AVC VIDEO") AND/OR
- DECODE AVC VIDEO THAT WAS ENCODED BY A CONSUMER ENGAGED IN A PERSONAL AND NONCOMMERCIAL ACTIVITY AND/OR WAS OBTAINED FROM A VIDEO PROVIDER LICENSED TO PROVIDE AVC VIDEO.

NO LICENSE IS GRANTED OR SHALL BE IMPLIED FOR ANY OTHER USE. ADDITIONAL INFORMATION MAY BE OBTAINED FROM MPEG LA, L.L.C. SEE [HTTP://WWW.MPEGLA.COM](http://www.mpegla.com)

.....

MEMO

.....

ZOOM[®]

ZOOM CORPORATION

4-4-3 Kanda-Surugadai, Chiyoda-ku, Tokyo 101-0062 Japan

<http://www.zoom.co.jp>