

H6essential

Handy Recorder

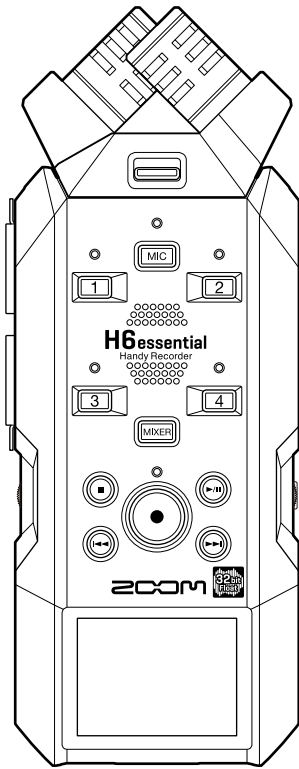

Operation Manual

You must read the Usage and Safety Precautions before use.

©2024 ZOOM CORPORATION

Copying or reprinting this manual in part or in whole without permission is prohibited.

Product names, registered trademarks and company names in this document are the property of their respective companies. All trademarks and registered trademarks in this document are for identification purposes only and are not intended to infringe on the copyrights of their respective owners.

Proper display is not possible on grayscale devices.

Notes about this Operation Manual

You might need this manual in the future. Always keep it in a place where you can access it easily. The contents of this document and the specifications of the product could be changed without notice.

- Microsoft and Windows are trademarks of the Microsoft group of companies.
- Mac, macOS, iPadOS and Lightning are trademarks of Apple Inc.
- iOS is a registered trademark or trademark of Cisco Systems, Inc. and affiliated companies in the USA and other countries and is used under license.
- App Store is a service mark of Apple Inc.
- The Bluetooth® word mark and logo are registered trademarks of Bluetooth SIG, Inc., and these marks are used under license by ZOOM CORPORATION.
- The microSDXC logo is a trademark of SD-3C LLC.
- USB Type-C is a trademark of the USB Implementers Forum.
- Recording from copyrighted sources, including CDs, records, tapes, live performances, video works and broadcasts, without permission of the copyright holder for any purpose other than personal use is prohibited by law. ZOOM CORPORATION will not assume any responsibility related to infringements of copyrights.

Contents

Notes about this Operation Manual.....	2
H6essential overview.....	6
Achieving high audio quality throughout recording and editing.....	6
Functions of parts.....	10
Overview of screens that appear.....	16
Recording process.....	27
Making preparations.....	28
Inserting microSD cards.....	28
Supplying power.....	29
Connecting input devices.....	31
Turning the power on/off.....	38
Setting the guide sound (first time starting up).....	40
Setting the language shown (first time starting up).....	41
Setting the date format (first time starting up).....	42
Setting the date and time (first time starting up).....	43
Setting the type of batteries used (first time starting up).....	45
Preventing misoperation (HOLD function).....	46
Making input settings.....	47
Enabling tracks for recording.....	47
Converting mic capsule input to mono.....	48
Setting phantom power.....	49
Reducing noise (Lo Cut).....	51
Enabling stereo linking.....	52
Setting the side level when recording mid-side stereo.....	54
Making output settings.....	56
Adjusting the line output level.....	56
Recording.....	58
Monitoring input sounds.....	58
Adjusting the monitoring balance of input sounds.....	60
Making recording settings.....	62
Recording.....	67
Adding marks during recording.....	69
Moving the file being recorded to the TRASH folder.....	70
Playing recordings.....	71
Playing recordings.....	71
Adjusting the volume balance of all tracks.....	73
Adjusting the line output level.....	75
Automatic volume adjustment during playback.....	76
Changing the playback speed.....	77
Repeat playback of a set interval (A-B repeat).....	78

Changing the format and exporting files.....	80
Moving the file being played to the TRASH folder.....	83
Managing files.....	84
H6essential folder and file structure.....	84
Checking files.....	87
Using as an audio interface.....	88
For Windows.....	88
Connecting to computers, smartphones and tablets.....	88
Making input settings and monitoring adjustments.....	92
Making output settings.....	93
Recording on the H6essential while using it as an audio interface.....	95
Disconnecting from computers, smartphones and tablets.....	96
Transferring files to computers and other devices.....	97
Connecting to computers, smartphones and tablets.....	97
Disconnecting from computers, smartphones and tablets.....	99
Managing microSD cards.....	100
Formatting microSD cards.....	100
Testing microSD cards.....	101
Deleting files in the TRASH folder.....	104
Using timecode.....	105
Timecode overview.....	105
Connecting with an UltraSync BLUE.....	107
Making various settings.....	110
Setting the language shown.....	110
Setting the date and time.....	111
Setting the date format.....	113
Setting display power saving.....	115
Setting the display brightness.....	116
Setting the type of batteries used.....	117
Setting the time until the power turns off automatically.....	119
Using the guide sound accessibility feature.....	121
Setting the guide sound (accessibility).....	121
Setting the guide sound volume.....	123
Checking guide sound information.....	124
Installing guide sounds.....	125
Restoring the factory default state.....	126
Managing the firmware.....	127
Checking the firmware versions.....	127
Updating the firmware.....	128
Operating the H6essential from a smartphone/tablet.....	129
Disconnecting from smartphones and tablets.....	131
Checking the latest information for the H6essential.....	132
Appendix.....	133
Troubleshooting.....	133

H6essential metadata list..... 135
Specifications..... 139

H6essential overview

Achieving high audio quality throughout recording and editing

With dual A/D converter circuits and support for 32-bit float WAV files, the H6essential can maintain the highest audio quality from recording through editing in a DAW or other software.

Recording

Dual A/D converter circuits enable recording both loud and quiet sounds without making gain adjustments.



Editing with DAWs and other software

Since files are recorded using 32-bit float WAV format, audio quality can be retained when editing.



Dual A/D converter circuit overview

For each input circuit, the H6essential has two A/D converters with different input gains. This design enables high-quality audio recording without the need to adjust gain settings, a step that is normally indispensable.

Providing amazing dynamic range

By combining two A/D converters, a wide dynamic range not possible with a single A/D converter has been realized.

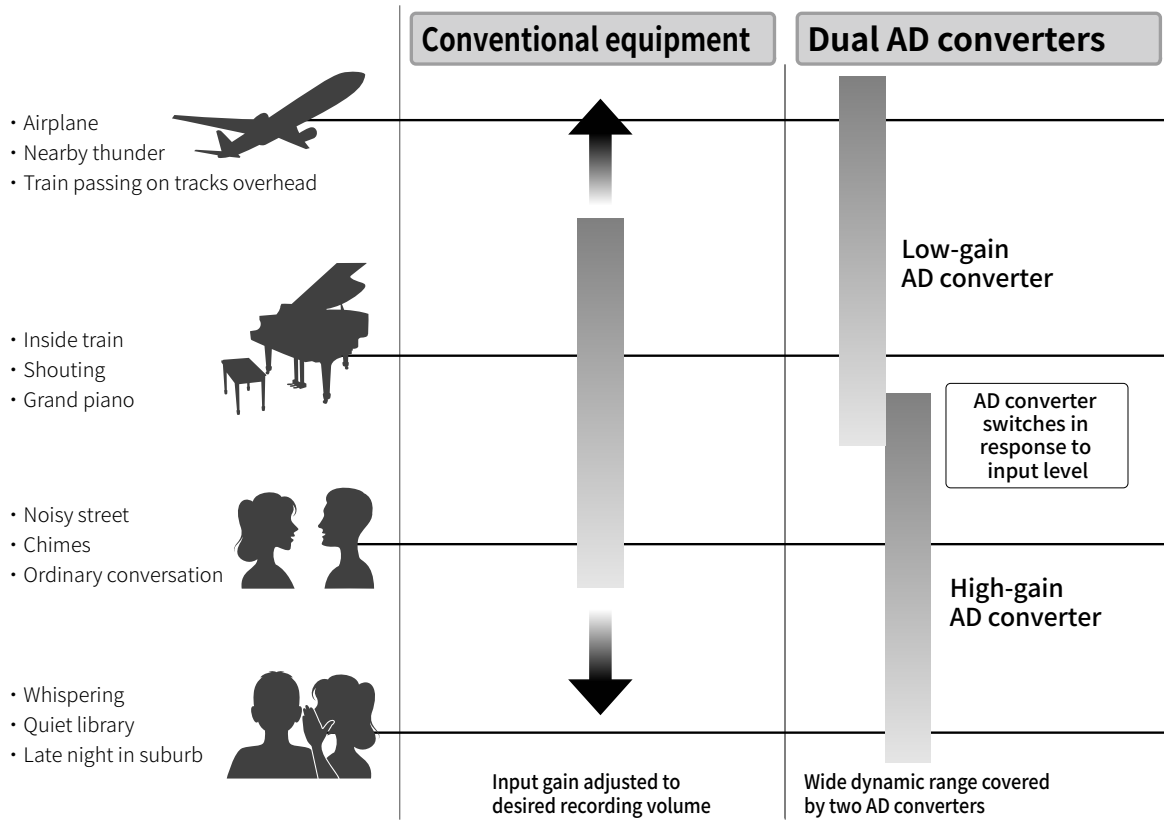

Switching between two A/D converters

The H6essential constantly monitors data from the two A/D converters, and automatically selects the one that provides the best recording results.

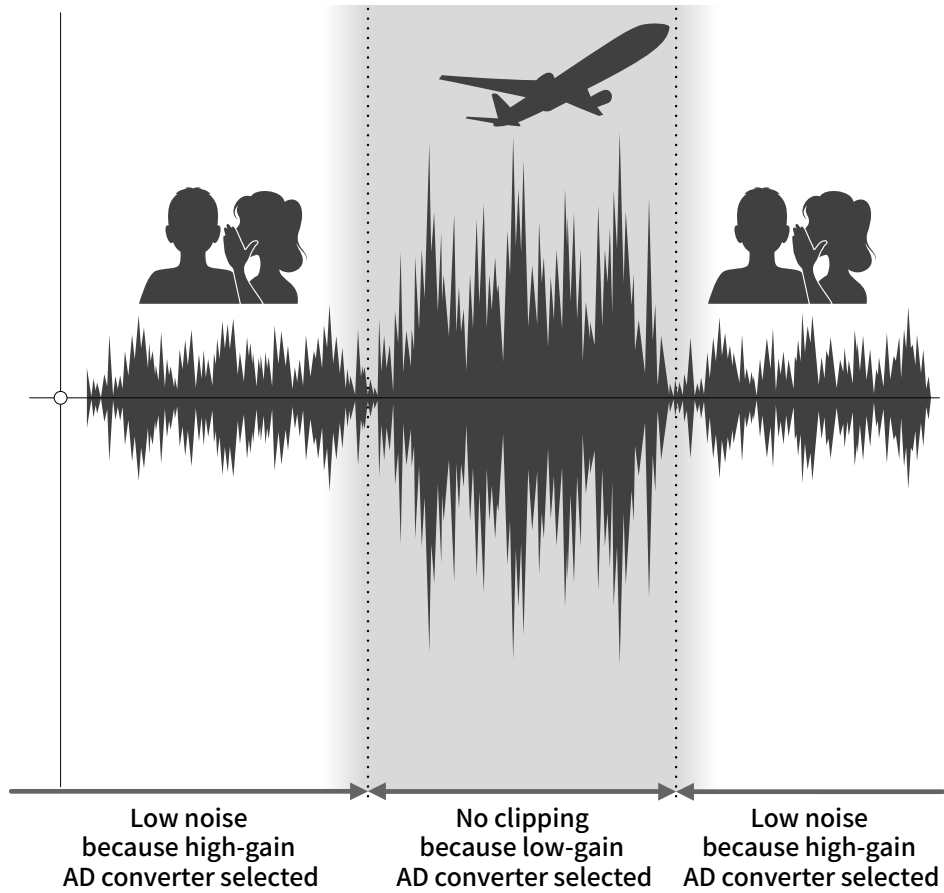

32-bit float WAV file overview

32-bit float WAV files have the following advantages over conventional 16/24-bit WAV files.

Due to these advantages, the audio quality of recording can be maintained afterward when editing in a DAW or other software.

Resolution advantage

32-bit float WAV files have the advantage of being able to maintain high resolution even at low volumes. As a result, quiet sounds can be made louder when editing after recording without degrading their quality.

■ 16/24-bit WAV

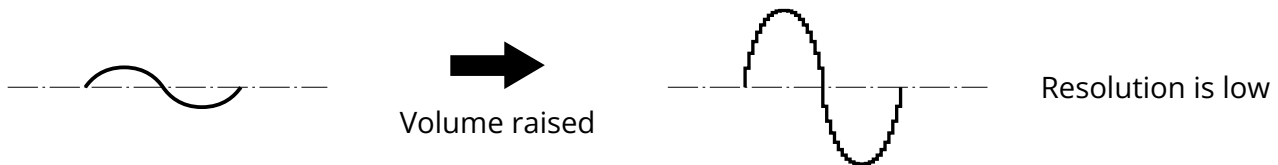

■ 32-bit float WAV



Clipping advantage

If a waveform sounds clipped when output from the H6essential or in a DAW, it can be edited after recording to lower its volume and restore an unclipped waveform because the data in the 32-bit float WAV file itself is not clipped.

■ 16/24-bit WAV

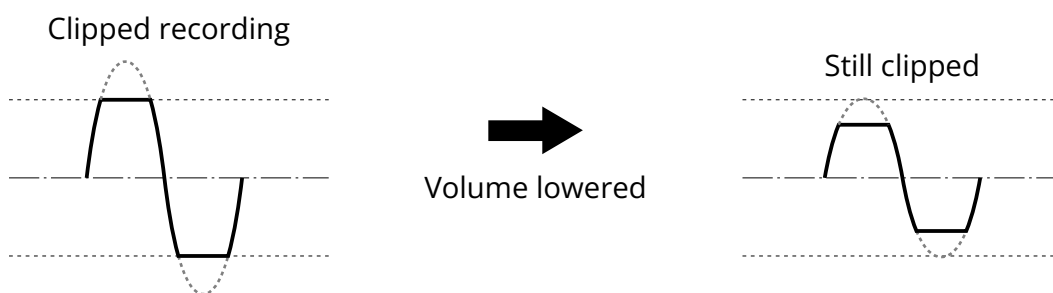

■ 32-bit float WAV

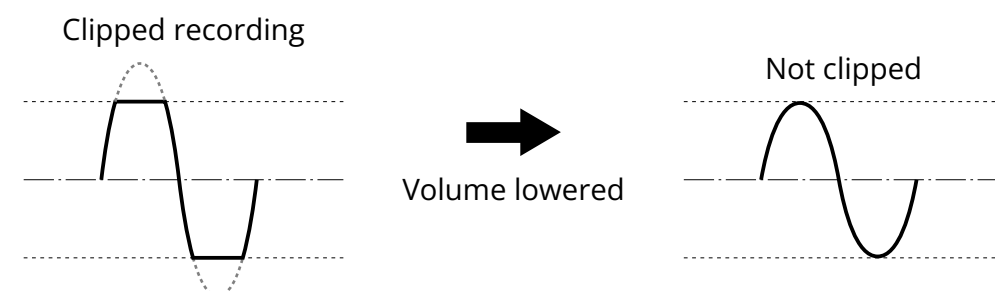

Functions of parts

Top and bottom

■ Top

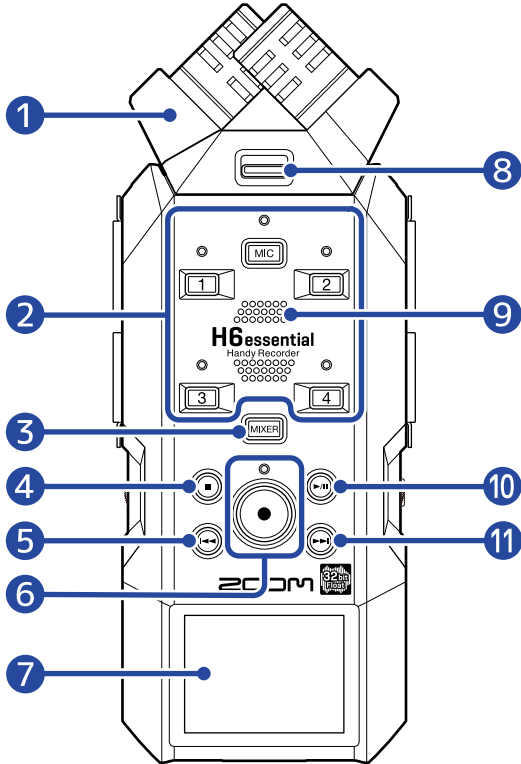

■ Bottom

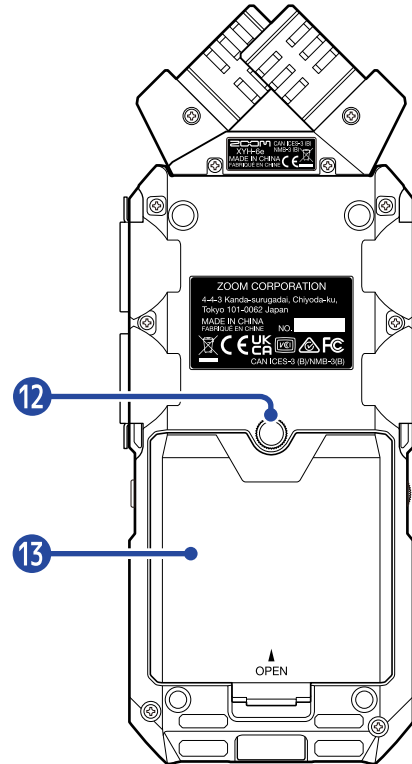

1 Mic capsule (XY mic)

The included XY mic capsule is a stereo mic with two crossing directional mics. This mic can record three-dimensional sound with natural depth and width. (→ [Mic capsule overview](#))

In addition to the XY mic capsule, other mic capsules (sold separately) that are compatible with the H6essential can be attached according to the application. (→ [Attaching mic capsules](#))

2 Track buttons and status indicators

These turn on/off the corresponding tracks. Status indicators will light red when tracks are on.

3 MIXER button

This opens the [Mixer Screen](#).

4 STOP button

This stops recording/playback.

Press this when the [Playback Screen](#) or one of the settings screens (excluding some screens) is open to return to the [Home Screen](#).

5 REW button

Press during playback or when paused to move to the previous file, the beginning of the file, or the previous mark.

Press and hold to search backward.

6 REC button and indicator

This starts recording. The indicator lights during recording.
Press when recording to stop recording.

7 Display

This shows various types of information.

8 Mic capsule lock button

Use this when attaching and removing mic capsules. (→ [Attaching mic capsules](#))

9 Speaker

Sound is output here during file playback.

If headphones are connected to the Headphone jack, sound will not be output from the speaker.

10 PLAY/PAUSE button

This starts and pauses playback.

11 FF button

Press during playback or when paused to move to the next file or the next mark.

Press and hold to search forward.

12 Tripod mounting threads

This can be used to attach the H6essential to a tripod, for example.

13 Battery cover

Open this when installing or removing AA batteries. (→ [Installing batteries](#))

Left and right sides

Left side

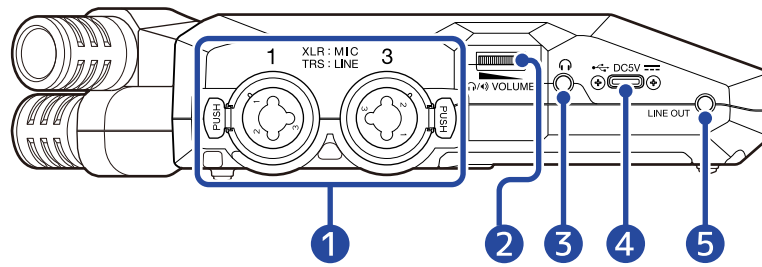

Right side

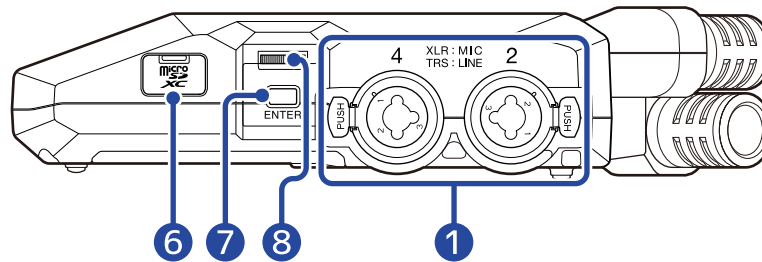

1 INPUT 1, INPUT 2, INPUT 3 and INPUT 4 jacks

Connect mics and instruments to these. These can be used with XLR and TRS plugs. When disconnecting an XLR plug, pull it while pushing the connector lock release button.

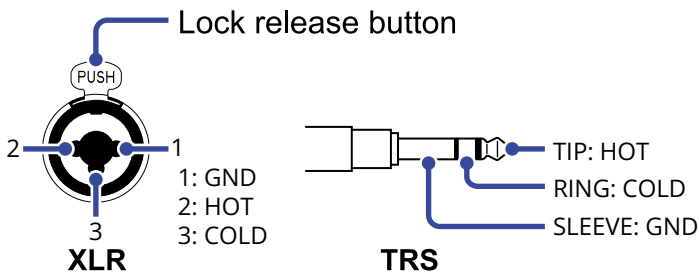

2 VOLUME

This adjusts the volume of the headphone output and built-in speaker.

3 Headphone jack

This can output sound to headphones.

4 USB port (Type-C)

Connect this to a computer, smartphone or tablet to use file transfer functions and to use the H6essential as an audio interface. This supports operation on USB bus power.

5 LINE OUT jack

This outputs sound to a connected device.

6 microSD card slot

Insert a microSD card here.

7 ENTER button

Use this to confirm items selected using the Selection dial.

8 Selection dial

Use this to select items on the various screens.

■ Front end

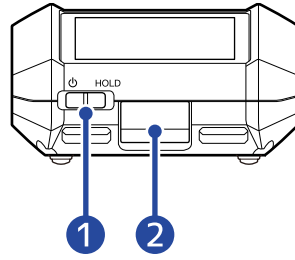

1 POWER/HOLD switch

Use this to turn the power on/off and to disable button operation.

2 REMOTE connector

Connect a ZOOM BTA-1 or other dedicated wireless adapter here.

This enables use of the H6essential Control smartphone/tablet app to operate the H6essential wirelessly.

In addition, this enables SMPTE timecode to be input to the H6essential using an UltraSync BLUE made by Timecode Systems.

Mic capsule overview

The H6essential includes a mic capsule (XY mic).

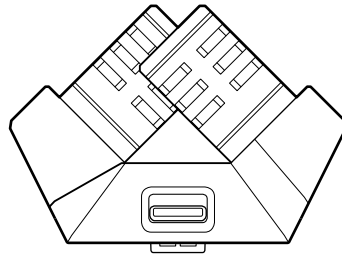

Characteristics

By having left and right diaphragms face inward perpendicularly to each other, a wide recording range can be covered while fully capturing sound sources in the center.

Moreover, since the points of recording are almost the same, no phase differences occur between the left and right channels.

Providing a three-dimensional sound with natural depth and width, this technique is ideal for recording when you want to capture a specific sound source that is nearby or at a medium distance.

Use examples: solo and chamber music performances, live rehearsals, field recordings, etc.

Overview of screens that appear

In this section, we explain the screens shown on the display of the H6essential.

Home Screen

This screen appears on the display when the H6essential power is turned on. This shows conditions of the H6essential, including recording status and input signal waveforms.

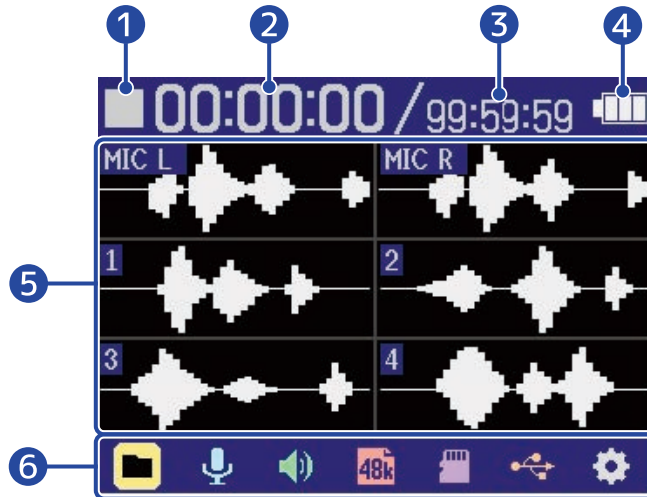

1 Status icon

The recording status is shown by an icon.

-  Stopped
-  Recording

2 Elapsed recording time

This shows the current elapsed recording time.

3 Recordable time

This is the current available recording time.

4 Remaining battery charge

This is shown when operating on batteries. When the remaining battery charge becomes low, replace the batteries (→ [Installing batteries](#)) or connect an AC adapter (→ [Connecting an AC adapter](#)) or portable battery (→ [Using other power sources](#)).

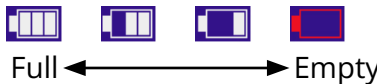

5 Waveform display (mic capsule, inputs 1-4)

This shows the waveforms of signals input into the H6essential. Waveforms that are currently being recorded are shown in red.

The input types are shown at the left end of each waveform.

- MIC L: Mic capsule left channel
- MIC R: Mic capsule right channel

- 1: INPUT 1
- 2: INPUT 2
- 3: INPUT 3
- 4: INPUT 4

A muted icon will be shown when a track is off. (→ [Enabling tracks for recording](#))









6 Menu bar

This shows icons for various setting items so settings screens, including input, output, recording and system, can be opened and settings can be made easily.

Use  to select an icon, and press  to conduct the following operations.



■ When recording paused



-  File List: This opens the [File List Screen](#) where the files on the microSD card can be checked. (→ [File List Screen](#))
-  Input: This opens a screen with settings related to input. (→ [Making input settings](#))
-  Output: This opens a screen with settings related to output. (→ [Making output settings](#))
-  Rec Settings: This opens a screen with settings related to recording. (→ [Making recording settings](#))
-  SD card: This opens a screen with settings related to microSD cards. (→ [Managing microSD cards](#))
-  USB: This opens a screen to connect the H6essential to a computer, smartphone or tablet in order to check and move files on the microSD card and make audio interface settings. (→ [Managing microSD cards, Using as an audio interface](#))
-  System: This opens a screen where various unit settings, including date/time and display settings, can be made. (→ [Making various settings](#))

■ When recording



-  Mark: Use this to add a mark to the file being recorded. (→ [Adding marks during recording](#))
-  Output: This opens a screen with settings related to output. (→ [Making output settings](#))
-  Trash: Use this to move the file being recorded to the TRASH folder. (→ [Moving the file being recorded to the TRASH folder](#))

HINT

When the [Playback Screen](#) or a settings screen is open (with some exceptions), press  to return to the Home Screen.



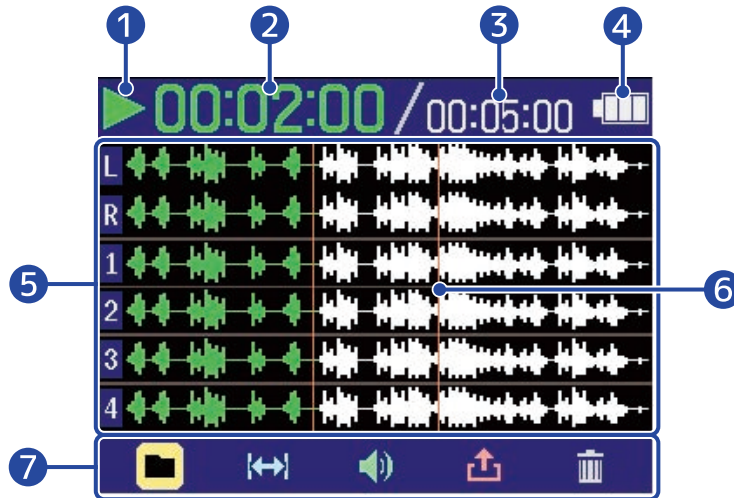

Playback Screen

When the [Home Screen](#) is open, pressing  to start playback will open this screen on the display. This shows playback conditions of the H6essential, including playback time and recording file waveforms.



1 Status icon

The playback status is shown by an icon.

-  : Playing back
-  : Paused
-  : Searching backward
-  : Searching forward

2 Playback time

This shows the elapsed time since the start of playback.

3 File length

This shows the length of the file currently playing.

4 Remaining battery charge

This is shown when operating on batteries. When the remaining battery charge becomes low, replace the batteries (→ [Installing batteries](#)) or connect an AC adapter (→ [Connecting an AC adapter](#)) or portable battery (→ [Using other power sources](#)).



5 Waveform display (mic capsule, inputs 1–4)

This shows the waveforms of the recorded files being played. The parts of the waveforms that have already been played appear green.

The positions of marks can also be checked. (→ [Adding marks during recording](#))

The input types are shown at the left end of each waveform.

- L: Mic capsule left channel
- R: Mic capsule right channel

- 1: INPUT 1
- 2: INPUT 2
- 3: INPUT 3
- 4: INPUT 4

The waveform will be shown in gray when a track is off.



6 Mark bar





This shows a mark added to the file being played back.

7 Menu bar



This shows icons for various setting items so settings screens, including output and repeat, can be opened and settings can be made easily.

Use  to select an icon, and press  to conduct the following operations.



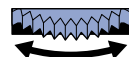

-  File List: This opens the File List Screen where the files on the microSD card can be checked. (→ [File List Screen](#))
-  A-B Repeat: Use this to set the starting and ending points for repeat playback. (→ [Repeat playback of a set interval \(A-B repeat\)](#))
-  Output: This opens a screen with settings related to output. (→ [Making output settings](#))
-  Export: Use this to change the format, for example, of the playing file and export it. (→ [Changing the format and exporting files](#))
-  Trash: Use this to move the file being played to the TRASH folder. (→ [Moving the file being played to the TRASH folder](#))

HINT

- Press  to stop playback and return to the [Home Screen](#).
 - When the [File List Screen](#) is open, use  to select  (Play View) in the Menu bar and press  to open the [Playback Screen](#).
-



File List Screen

When the [Home Screen](#) or [Playback Screen](#) is open, use  to select  (File List) and press  to open it.

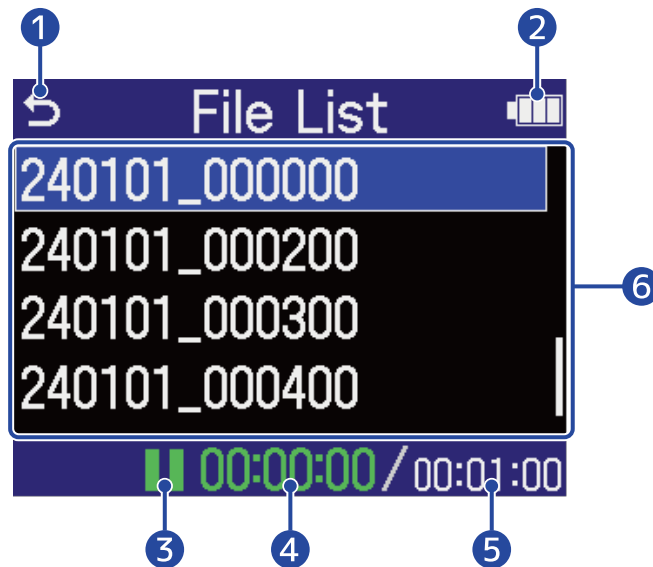
This lists the files on the microSD card on the display, allowing the content of the card to be checked and files to be played and moved to the TRASH folder, for example.

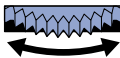

1

Use  to select this and press  to return to the [Home Screen](#) or [Playback Screen](#).





2 Remaining battery charge

This is shown when operating on batteries. When the remaining battery charge becomes low, replace the batteries (→ [Installing batteries](#)) or connect an AC adapter (→ [Connecting an AC adapter](#)) or portable battery (→ [Using other power sources](#)).



3 Status icon

The playback status is shown by an icon.

- : Playing back
- : Paused
- : Searching backward
- : Searching forward

4 Playback time



This shows the elapsed time since the start of playback.

5 File length



This shows the length of the currently selected file.

6 File list

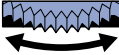

This shows the files on the microSD card in a list.

- Use  to select files.
- When a list has more files than will fit on the display, a scrollbar will appear on the right edge.
- Use  to select a file and press  to show the Menu bar at the bottom of the screen.

Menu bar

Use  to select a setting item, and press  to conduct the following operations.



-  Play View: This opens the [Playback Screen](#) for the selected file. (→ [Playback Screen](#))
-  Trash: Use this to move the selected file to the TRASH folder. (→ [Moving the file being played to the TRASH folder](#))
-  Back: This closes the Menu bar and enables file selection again.

HINT

Press  to return to the [Home Screen](#).

Mixer Screen

Press **MIXER** to open it.

The volume balance of sound from all inputs and playback tracks can be mixed.

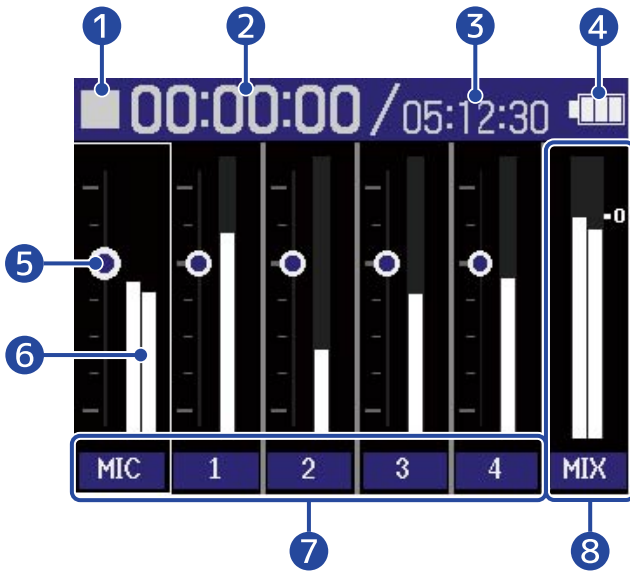

Screen during playback

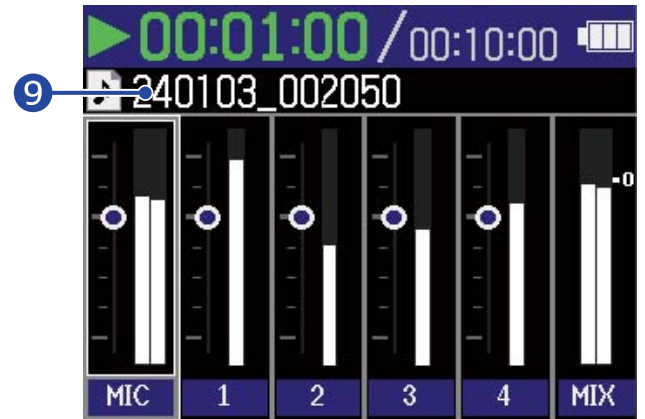

1 Status icon

The playback status is shown by an icon.

- : Recording
- :Recording paused
- : Playing
- : Playback paused
- : Searching backward
- : Searching forward

2 Elapsed recording time / playback time

During recording, this shows the current elapsed recording time.

During playback: This shows the elapsed time since the start of playback.

3 Available recording time / file length

During recording, this shows the current available recording time.

During playback This shows the length of the file currently playing.

4 Remaining battery charge

This is shown when operating on batteries. When the remaining battery charge becomes low, replace the batteries (→ [Installing batteries](#)) or connect an AC adapter (→ [Connecting an AC adapter](#)) or portable battery (→ [Using other power sources](#)).



5 Volume setting

These show the volume settings for each track.

6 Level meters

These level meters show the monitoring levels for each track.

7 Track status

These show the names and statuses of tracks.

-  : Track 1 on
-  : Track 1 off

When the volume setting of a track is being adjusted, the setting value will be shown numerically instead of the track name.

A muted icon will be shown in the level meter area when a track is off. (→ [Enabling tracks for recording](#))



8 Stereo mix track

These level meters show the monitoring levels of the stereo mix.

9 Playback file name



During playback, the name of the file playing is shown.

HINT

Press  to return to the [Home Screen](#) or [Playback Screen](#).

Input Settings Screen

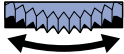
Use this screen to make settings related to inputs.

Use  to select a setting item or value, and press  to confirm.

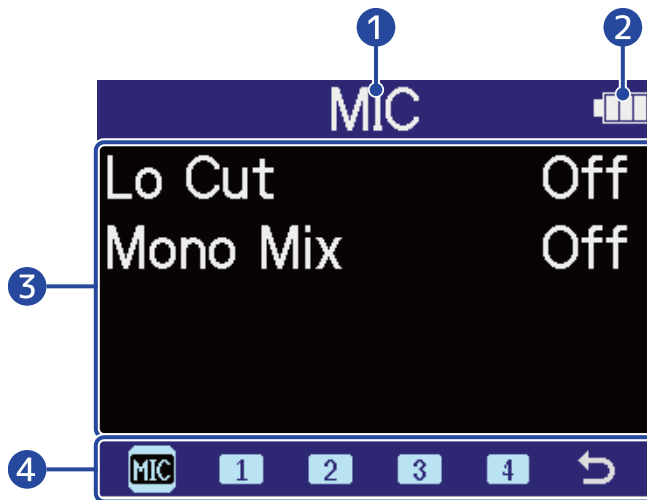

1 Name of input being set

2 Remaining battery charge

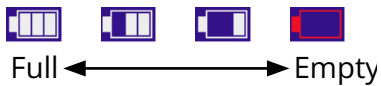

This is shown when operating on batteries. When the remaining battery charge becomes low, replace the batteries (→ [Installing batteries](#)) or connect an AC adapter (→ [Connecting an AC adapter](#)) or portable battery (→ [Using other power sources](#)).





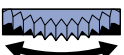

3 Setting items and values

4 Menu bar

The inputs that can be set are shown by icons.



Use  to select an input, and press  to make settings for that input.



-  MIC: Make settings for the mic capsule.
-  Input 1 –  Input 4: Make settings for inputs 1–4.
-  Exit: Return to the [Home Screen](#).

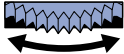

Other settings screens

Other screens can be used to make settings related to output, recording, SD cards, USB and the system.

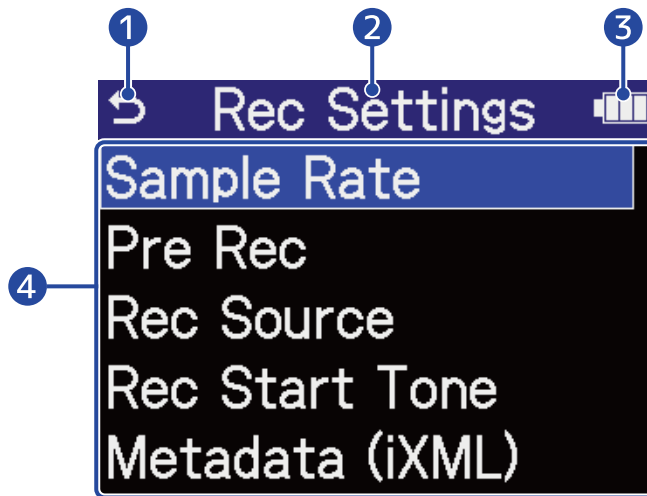
Use  to select a setting item or value, and press  to confirm.

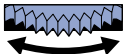

1 

Use  to select this and press  to return to the [Home Screen](#).

2 Setting screen name

3 Remaining battery charge





This is shown when operating on batteries. When the remaining battery charge becomes low, replace the batteries (→ [Installing batteries](#)) or connect an AC adapter (→ [Connecting an AC adapter](#)) or portable battery (→ [Using other power sources](#)).



4 Setting items

Recording process

Recording follows the process shown below.

Preparation before recording	<ul style="list-style-type: none">• Load a microSD card (→ Inserting microSD cards)• Prepare the power (→ Installing batteries, Connecting an AC adapter)• Connect mics, for example, to inputs (→ Connecting input devices)• Turn the power on (→ Turning the power on)• Make settings related to input (→ Making input settings)• Make settings related to recording (→ Making recording settings)
Recording	<ul style="list-style-type: none">• Press  to start recording and press  or  to stop recording (→ Recording)
Playing back and reviewing	<ul style="list-style-type: none">• Press  to start playback and press  to stop (→ Playing recordings)

Making preparations

Inserting microSD cards

1. When the power is off, open the microSD card slot cover, and insert a microSD card with the logo facing up all the way into the slot.

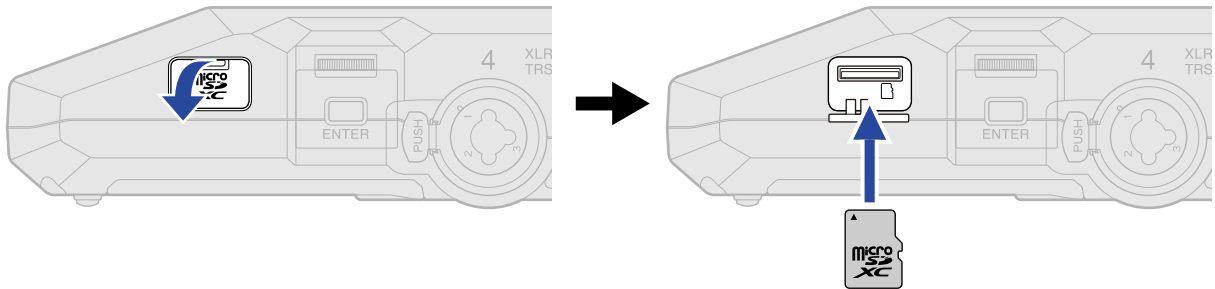



To remove a microSD card, push it further into the slot and then pull it out.

2. Close the microSD card slot cover.

NOTE

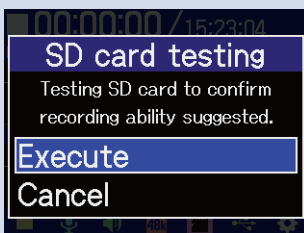
- Always make certain that the power is off when inserting or removing a microSD card. Inserting or removing a card while the power is on could result in data loss.
- When inserting a microSD card, be sure to insert the correct end with the top side up.
- Recording and playback are not possible when a microSD card is not loaded in the H6essential.
- Always format microSD cards in order to maximize their performance after purchasing them new or using them with a different device. (→ [Formatting microSD cards](#))
- When an SD card that has not been used with the H6essential before is loaded in it, an SD card test screen will open.

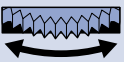

Use  to select "Execute" and press  to open the SD Card Screen. Test the card. (→ [Testing microSD cards](#))

- The following types of recording media are supported.
 - microSDHC: 4 GB – 32 GB
 - microSDXC: 64 GB – 1 TB

Supplying power

The H6essential can operate using batteries or a power supply connected to the USB port (AC adapter, USB bus power or portable battery).

Power from a power supply connected to the USB port will be used before batteries.

Installing batteries

Use 4 AA batteries when operating the H6essential on battery power.

1. When the power is off, push the latch up to open the battery cover.

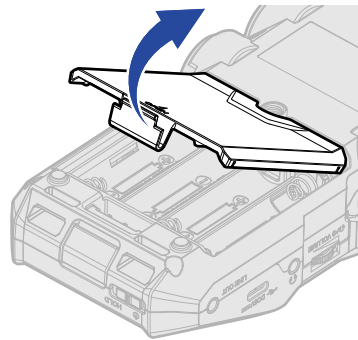

2. Install 4 AA batteries.

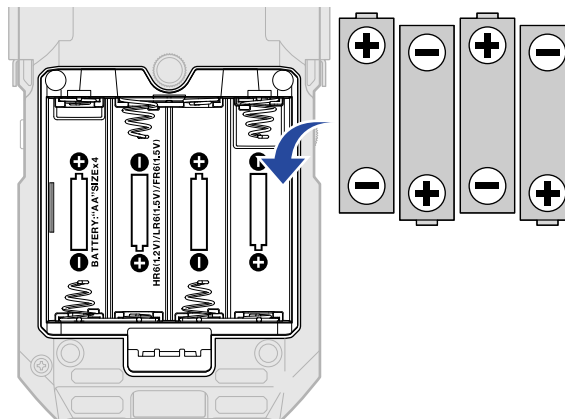

3. Replace the battery cover.

NOTE

- Use only one type of battery (alkaline, NiMH or lithium) at a time.
- Set the type of battery used correctly so that the amount of remaining battery charge can be shown accurately. (→ [Setting the type of batteries used](#))
- If the batteries run out of charge, turn the power off immediately and install new batteries. The battery charge will always be shown when operating on battery power.

Connecting an AC adapter

Connect the cable of a dedicated AC adapter (AD-17) to the USB port (Type-C) and connect the adapter to an outlet.

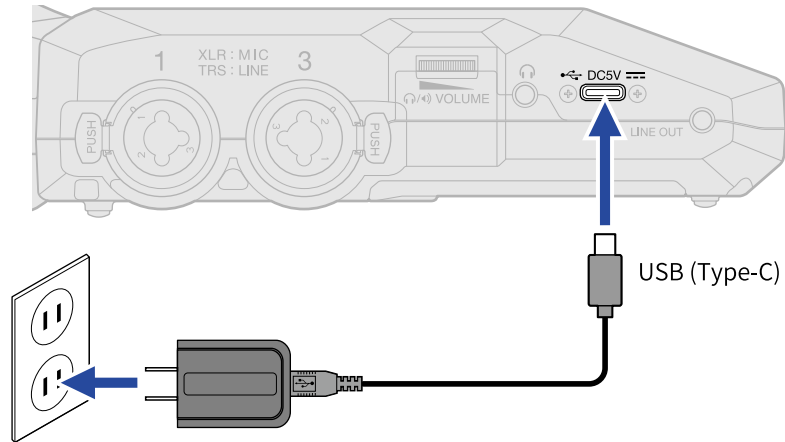

Using other power sources

By connecting the USB port (Type-C) to a computer, the H6essential can be operated using USB bus power. Moreover, it can also be powered by a 5V portable battery (commercially-available).

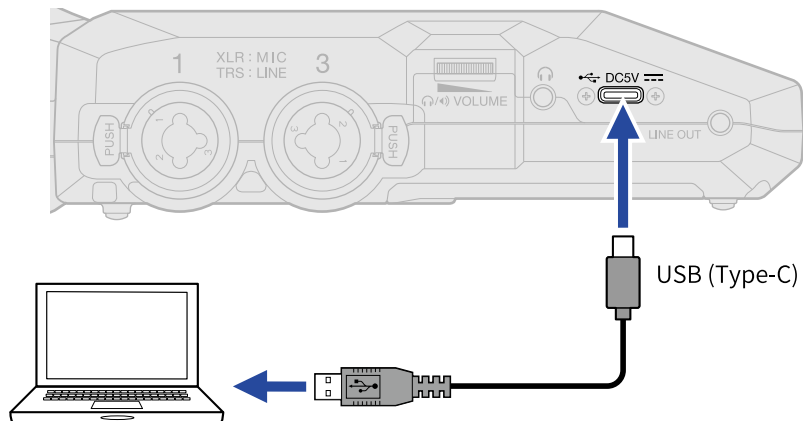

Connecting input devices

Attaching mic capsules

1. While pressing the mic capsule lock button (1) up, slide the protective cap (2) forward and remove it.

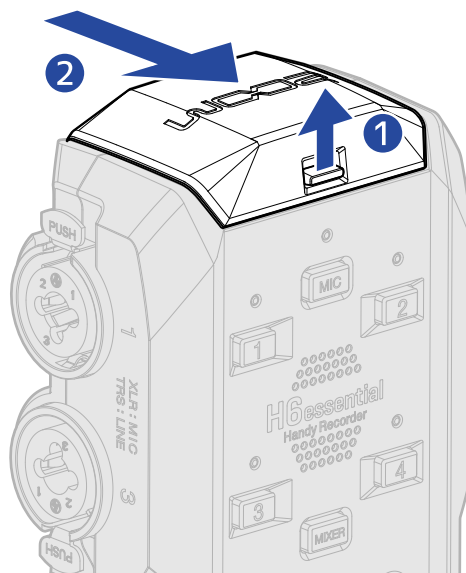

2. Attach the mic capsule to the H6essential.
Align the protrusions on the mic capsule with the grooves on the H6essential and slide it until it clicks into place.

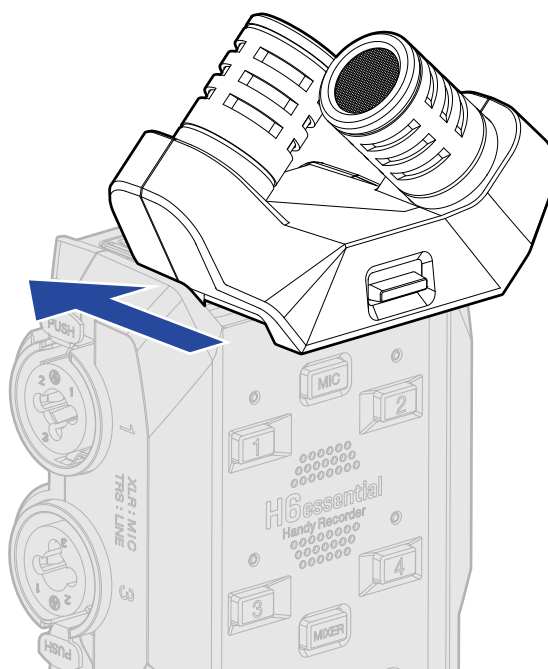

NOTE

- Do not use too much force when disconnecting. Doing so could damage the mic or the main unit.
- Always make certain that the power is off when connecting and disconnecting mic capsules.
- Attach the protective cap when a mic capsule will not be connected for a long time. Keep the protective cap so that it will not be lost.

Connecting mics and other devices to inputs 1-4

In addition to input from the mic capsule, the H6essential also has inputs 1-4. These can be used together to input up to 6 channels.

Mics, mixers and other devices can be connected to inputs 1-4.

■ Connecting mics

Connect dynamic and condenser mics with XLR plugs to inputs 1-4.

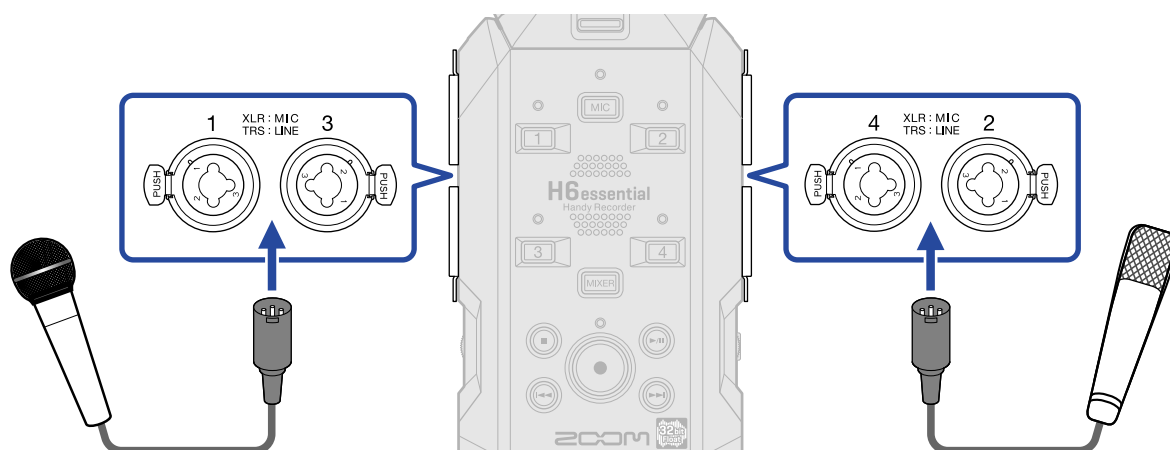

- Phantom power (+48V) can be supplied to condenser mics. (→ [Setting phantom power](#))
- When disconnecting a mic, pull the XLR plug while pushing the connector lock release button.

■ Connecting line level equipment

Connect the TRS plugs of mixers and other line-level equipment to inputs 1–4.

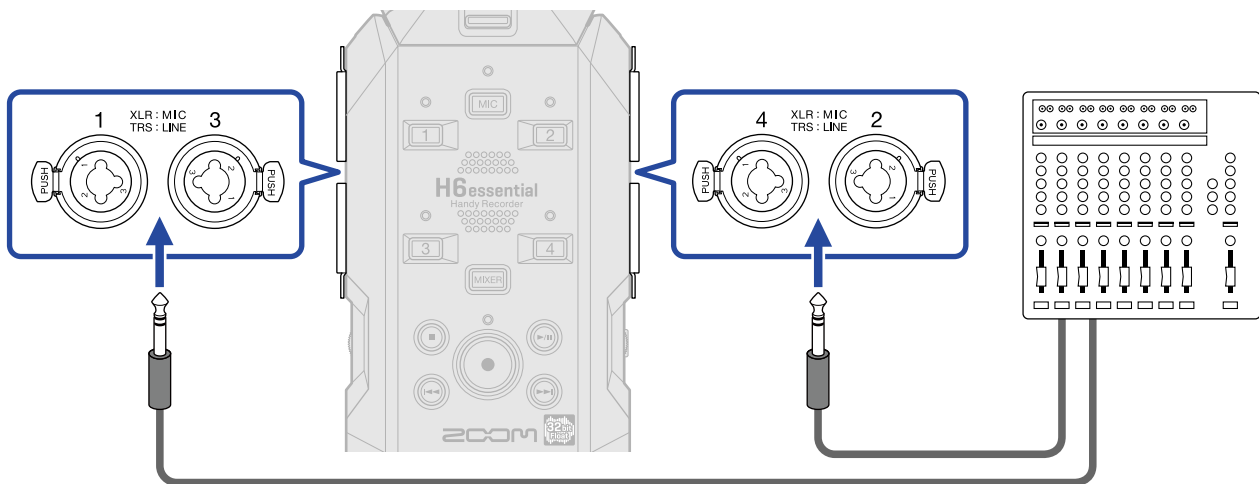

- Phantom power (+48V) can be supplied. (→ [Setting phantom power](#))
- Direct input of passive guitars and basses is not supported. Connect these instruments through a mixer or effects device.

NOTE

To make handling the levels of input signals easy, the H6essential sets input levels according to the types of plugs connected to the input jacks.

- When connecting mic-level devices, use XLR plugs.
- When connecting line-level devices, use TRS plugs.

Connection examples

Recording audio is possible in the following kinds of situations.

■ Recording performances with a voice and instrument

The sound of an instrument being played can be recorded using the mic capsule attached to the H6essential while vocals are recorded with a connected mic.



■ Concert recording

The sounds of the performance and the audience can be recorded using the mic capsule attached to the H6essential while a stereo mix or individual channels are recorded separately from a mixer.

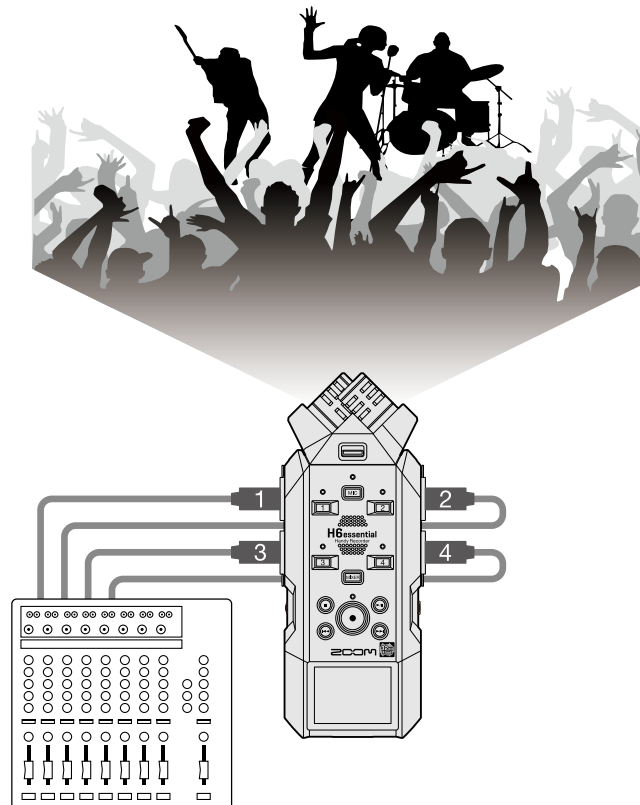

■ Live streaming a podcast

Audio can be streamed in real time using the H6essential and connected mics. (→ [Using as an audio interface](#))

While streaming audio in real time, the H6essential can simultaneously record. (→ [Recording on the H6essential while using it as an audio interface](#))

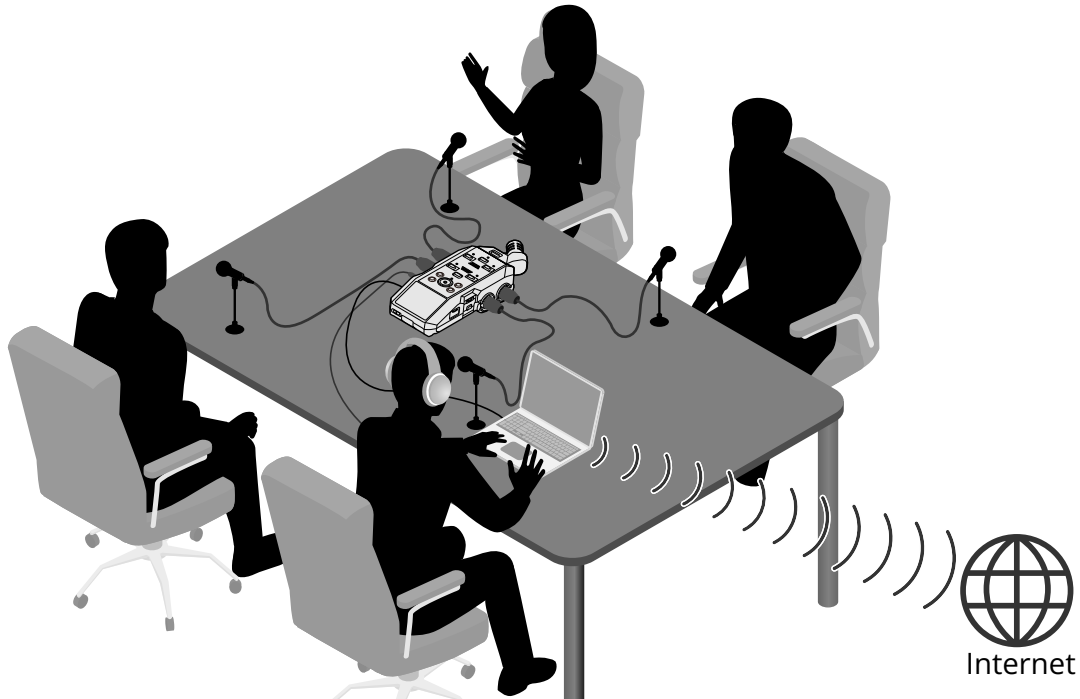

■ Capturing video

Audio and video can be captured simultaneously using the H6essential and a camera.

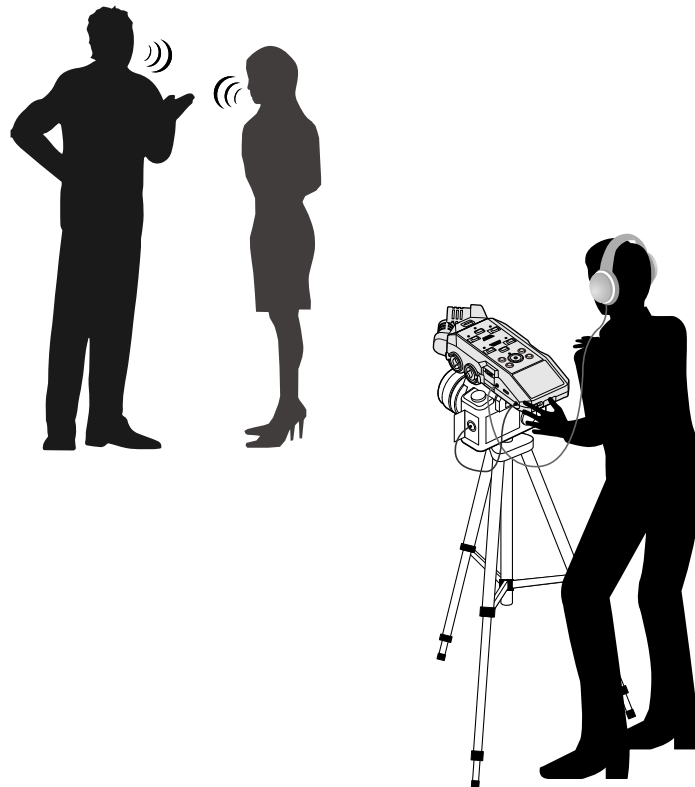

HINT

If the H6essential is placed directly on a table when recording using a mic capsule attached to it, reflected sound can interfere with recording and reduce clarity. We recommend using a tripod, for example, to distance it from the table. Placing something like a handkerchief can also be effective in reducing sound reflected from a table.

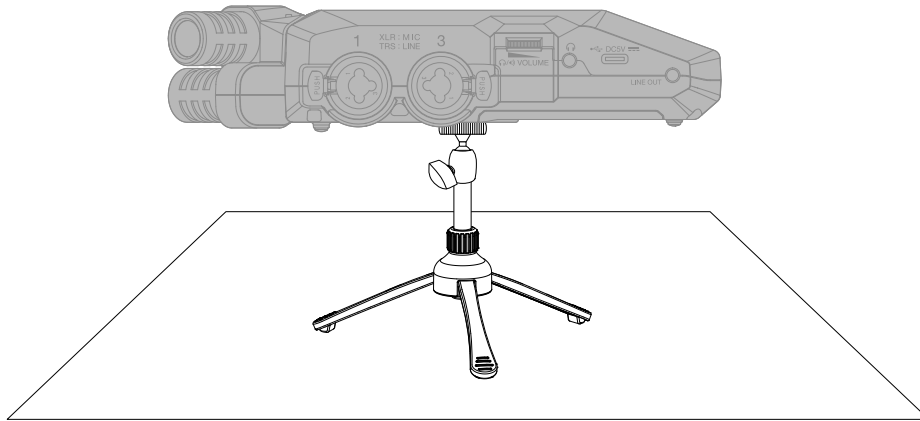

Turning the power on/off

Turning the power on

1. Slide  toward  until the display becomes active.

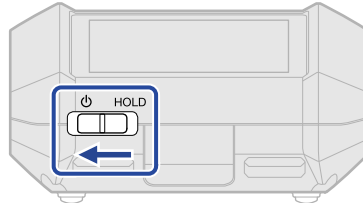

After the Startup Screen is shown, the [Home Screen](#) will open on the display.





The first time the power is turned on after purchase as well as when the H6essential has been reset to factory defaults, setting screens for the guide sound, display language and date and time will be shown. Make these settings. (→ [Setting the guide sound \(first time starting up\)](#), [Setting the language shown \(first time starting up\)](#), [Setting the date format \(first time starting up\)](#), [Setting the date and time \(first time starting up\)](#), [Setting the type of batteries used \(first time starting up\)](#))

NOTE

- The H6essential can be set so that its power will automatically turn off if it is not used for a set amount of time. (→ [Setting the time until the power turns off automatically](#))
- If “No microSD card!” appears on the display, confirm that a microSD card is inserted properly. (→ [Inserting microSD cards](#))
- If “Invalid SD Card!” appears on the display, the card is not formatted correctly. Format the microSD card or use a different microSD card. (→ [Formatting microSD cards](#), [Inserting microSD cards](#))

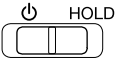
■ Turning the power off



1. Slide  toward  until "Please wait. Saving data..." appears on the display.
The display will darken and the power will turn off.

NOTE

- While "Please wait. Saving data..." is shown, the current settings of the H6essential are being saved. While "Please wait. Saving data..." is shown, do not disconnect the AC adapter or remove the batteries.
- The power cannot be turned off while recording. Turn the power off after recording stops.

Setting the guide sound (first time starting up)

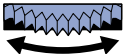
The first time the power is turned on after purchase as well as after the H6essential has been reset to factory defaults, set the guide sound when a screen to set it is shown.

1. Use  to select the setting item and press .

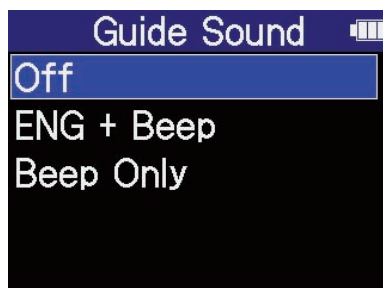

Setting	Explanation
Off	This turns off the guide sound.
XXX + Beep (“XXX” shows the installed language.)	Setting items will be read aloud in the installed language. A beeping sound will be used to notify the occurrence of error messages, recording starting/stopping and volume adjustment, for example. English is installed at the time of purchase, but other languages can be installed and used for reading as desired. (→ Installing guide sounds)
Beep Only	A beeping sound will be used to notify the occurrence of error messages, recording starting/stopping and volume adjustment, for example. Nothing will be read aloud.

After the guide sound setting is confirmed, set the language shown when a screen to set it opens. (→ [Setting the language shown \(first time starting up\)](#))

NOTE



The volume of the guide sound can also be adjusted. (→ [Setting the guide sound volume](#))

HINT

The guide sound setting can also be changed later on the System Settings Screen. (→ [Setting the guide sound \(accessibility\)](#))

Setting the language shown (first time starting up)

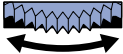

The first time the power is turned on after purchase as well as when the H6essential has been reset to factory defaults, after setting the guide sound, set the display language when a screen to set it is shown.

1. Use  to select the language, and press .



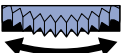

After the display language setting is confirmed, set the date format when a screen to set it opens. (→ [Setting the date format \(first time starting up\)](#))

HINT

- The display language setting can also be changed later on the System Settings Screen. (→ [Setting the language shown](#))
 - Use  to select  and press  to return to the previous setting screen.
-

Setting the date format (first time starting up)

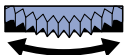
The first time the power is turned on after purchase as well as after the H6essential has been reset to factory defaults, after setting the display language, set the date format when a screen to set it is shown. The date written to recorded files will use the date format selected here.

1. Use  to select a date format and press .

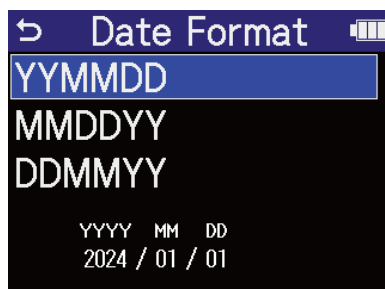

A specific example of the set date format will be shown at the bottom of the screen using the current date setting.



Setting	Explanation
YYMMDD	The date is shown in year, month, day order.
MMDDYY	The date is shown in month, day, year order.
DDMMYY	The date is shown in day, month, year order.

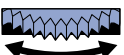

After the date format setting is confirmed, set the date and time when a screen to set them opens. (→ [Setting the date and time \(first time starting up\)](#))

HINT

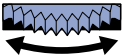

- The date format setting can also be changed later on the System Settings Screen. (→ [Setting the date format](#))
- Use  to select  and press  to return to the previous setting screen.

Setting the date and time (first time starting up)

The first time the power is turned on after purchase as well as after the H6essential has been reset to factory defaults, after setting the date format, set the date and time when a screen to set them is shown. The date and time are stored in recording files.



1. Use  to select the item to set and press .



2. Use  to change the value, and press .

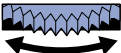

3. Repeat steps 1-2 to set the date and time.

4. After setting all the items, use  to select **OK** and press .





After the date and time setting is confirmed, set the battery type when a screen to set it opens. (→ [Setting the type of batteries used \(first time starting up\)](#))

NOTE



If power is not supplied for a long time, the date and time settings stored in the unit will be reset. If the Set Date/Time Screen appears during startup, set them again.

HINT

- The date and time settings can also be changed later on the System Settings Screen. (→ [Setting the date and time](#))
 - Use  to select  and press  to return to the previous setting screen.
-

Setting the type of batteries used (first time starting up)

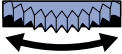
The first time the power is turned on after purchase as well as after the H6essential has been reset to factory defaults, after setting the date and time, set the type of batteries used in the H6essential when a screen to set it is shown. This is necessary to accurately show the remaining battery charge on the display.

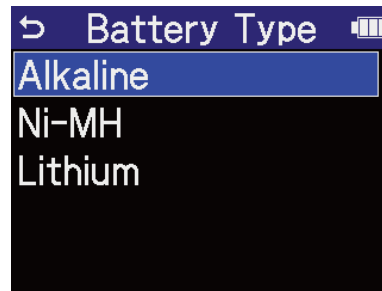

1. Use  to select the battery type and press .



Setting	Explanation
Alkaline	Alkaline batteries
Ni-MH	Nickel-metal hydride batteries
Lithium	Lithium batteries

After first-time settings are complete, the [Home Screen](#) will open.

HINT

- The battery type setting can be changed later on the Setting Screen. (→ [Setting the type of batteries used](#))
- Use  to select  and press  to return to the previous setting screen.

Preventing misoperation (HOLD function)

In order to prevent misoperation, the hold function can be used to disable the buttons on the H6essential.

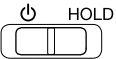
1. Slide  to HOLD.

This turns on the HOLD function, disabling operations using all buttons.

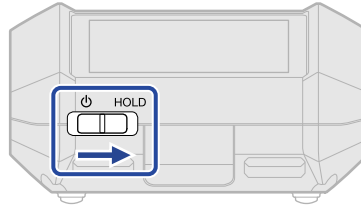

To deactivate the HOLD function, slide  back to the center position.



Making input settings

Enabling tracks for recording

Select which of the MIC (mic capsule) and input 1–4. tracks to record.

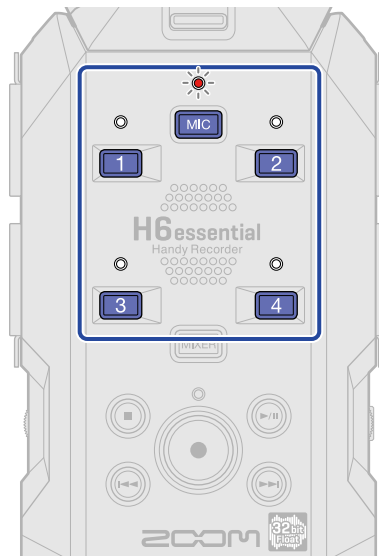
1. When the [Home Screen](#) is open, press the buttons of the tracks that you want to record. The status indicators for selected tracks will light red.





-  : Mic capsule
-  -  : Inputs 1–4

NOTE

- MIC cannot be selected when no mic capsule is attached. (→ [Attaching mic capsules](#))
- When tracks are stereo-linked, either of their buttons can be pressed to select both.

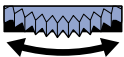

Converting mic capsule input to mono

Mic capsule input can be mixed to a single channel and handled as mono audio.

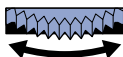
1. On the [Home Screen](#), use  to select  (Input) and press  .
This opens the [Input Settings Screen](#).

2. Use  to select **MIC** and press  .

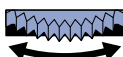

3. Use  to select "Mono Mix", and press  .



4. Use  to select On or Off, and press  .



When "On" is selected, mic capsule input will become mono.

NOTE



The recording file format will be changed in the same way. (→ [Folder and file structure](#))



- Set to "On": mono files
- Set to "Off": stereo files

Setting phantom power

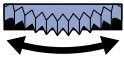
H6essential inputs 1–4 support phantom power and can provide +48 V. Turn on phantom power when condenser mics that require it are connected.

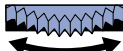

This can be turned on/off separately for each input.

1. On the [Home Screen](#), use  to select  (Input) and press  .
This opens the [Input Settings Screen](#).

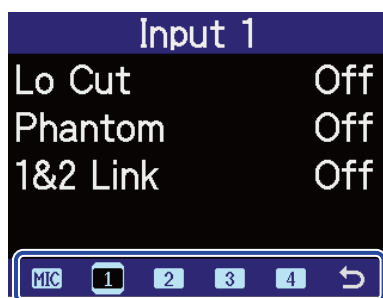
2. Use  to select the input for which you want to set phantom power and press  .



- **1** - **4** : Inputs 1–4

3. Use  to select “Phantom”, and press  .

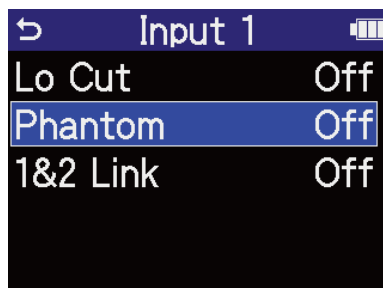

4. Use  to select On or Off, and press  .

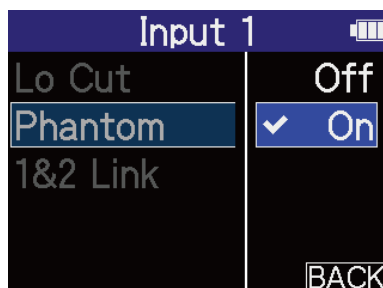

NOTE

When connecting devices that are not compatible with phantom power, do not turn on the phantom setting. Doing so could damage the device.



HINT



Phantom power is a function that supplies power to devices that require an external power supply, including some condenser mics.

+48 V is common.



Reducing noise (Lo Cut)



Low frequencies can be cut to reduce the sound of wind and vocal pop noises, for example.

1. On the [Home Screen](#), use  to select  (Input) and press  .
This opens the [Input Settings Screen](#).



2. Use  to select the input for which you want to set Lo Cut and press  .

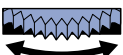

-  : MIC (mic capsule)
-  -  : Inputs 1-4

3. Use  to select “Lo Cut” and press  .

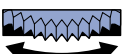

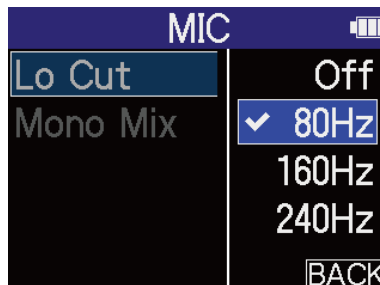

4. Use  to select the cutoff frequency and press  .





Lo Cut can be set to OFF, 80 Hz, 160 Hz or 240 Hz.

Enabling stereo linking

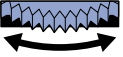

Using stereo-linking, input signals can be handled as stereo audio.

1. On the [Home Screen](#), use  to select  (Input) and press  .
This opens the [Input Settings Screen](#).

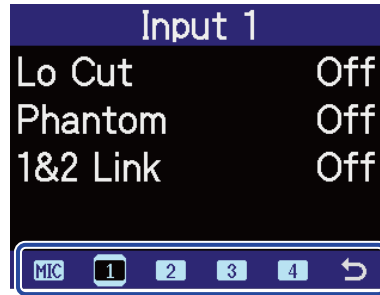

2. Use  to select an input that you want to stereo link and press  .

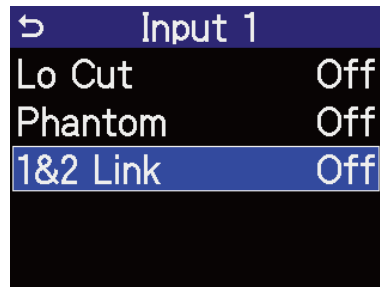

- **1** , **2** : This will stereo link inputs 1 and 2.
- **3** , **4** : This will stereo link inputs 3 and 4.

3. Use  to select "1&2 Link" or "3&4 Link" and press  .

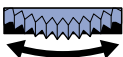

4. Use  to select the item to set and press .

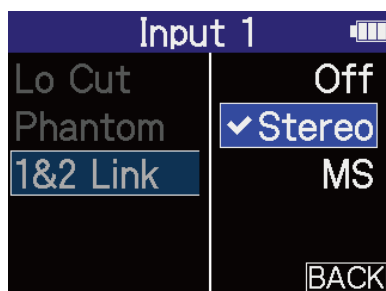

Setting	Explanation
Off	Input signals will be handled as mono audio.
Stereo	The two corresponding input signals will be handled as stereo audio. The odd track will become the left channel and the even track will become the right channel.
MS	The two corresponding input signals will be handled as audio captured in mid-side format. The odd track will become the mid and the even track will become the side.

HINT

Mid-side format is a recording method comprised of a mid mic and a side mic. The mid mic captures sound front and center while the side mic captures sound to the left and right. These signals are recorded and converted to stereo. At this time, the stereo width can be changed by adjusting the side mic recording level. (→ [Setting the side level when recording mid-side stereo](#))

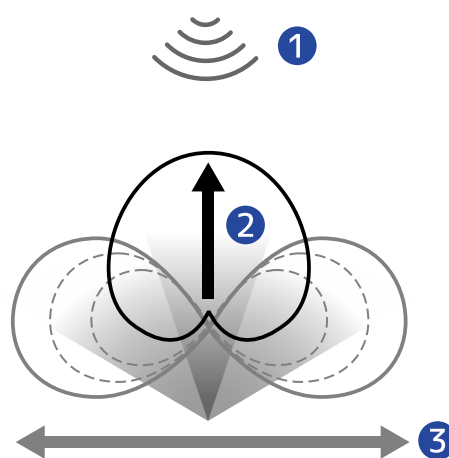



- ① Sound source
- ② Mid mic
- ③ Side mic



Setting the side level when recording mid-side stereo

The H6essential supports mid-side stereo recording.

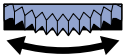
The mid mic captures sound front and center while the side mic captures sound to the left and right. These signals are recorded and converted to stereo. At this time, the stereo width can be adjusted by altering the side mic recording level.

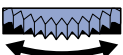

With the H6essential, the side level of the mid-side input signals can be set before recording, allowing the stereo width of the input sound to be adjusted.

1. On the [Home Screen](#), use  to select  (Input) and press  .
This opens the [Input Settings Screen](#).

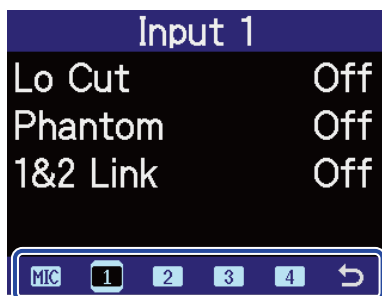

2. Use  to select an input that you want to set for mid-side stereo recording and press  .

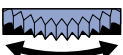

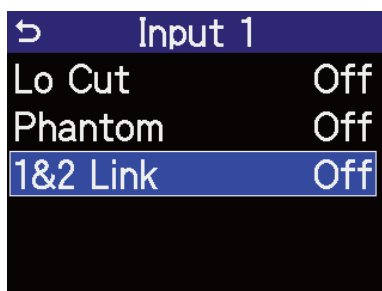

- **1** , **2** : This will stereo link inputs 1 and 2 for mid-side recording.
- **3** , **4** : This will stereo link inputs 3 and 4 for mid-side recording.

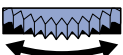
3. Use  to select "1&2 Link" or "3&4 Link" and press  .



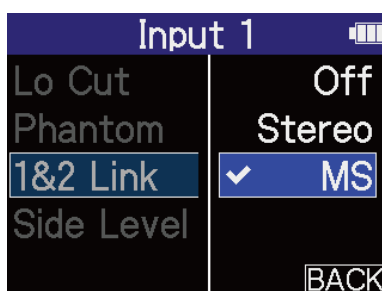

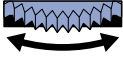
4. Use  to select MS, and press  .

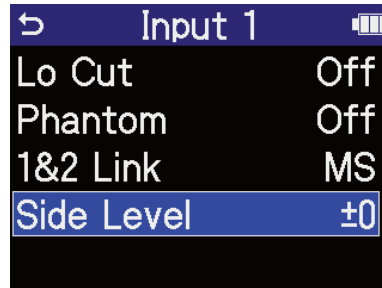

5. Use  to select "Side Level" and press .

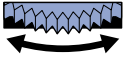

6. Use  to set the side level and press .

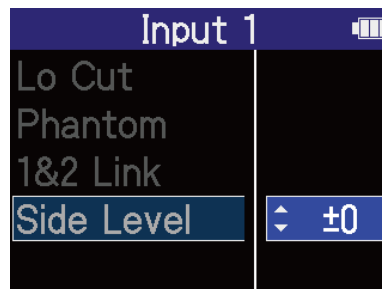

Setting	Explanation
-24 - +6	As the value increases, so does the stereo width.
Mute	The side mic will be muted.
RAW	The mid signal will be recorded to the left channel and the side signal will be recorded to the right channel of the stereo file. This setting is useful for changing the side level during post-production after recording.

Making output settings

Adjusting the line output level



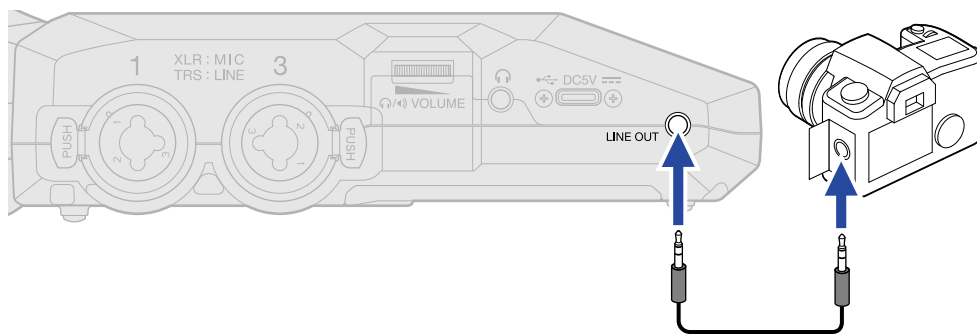

The line level output to other devices can be adjusted.

1. Minimize the input gain of the other device.
2. Use an audio cable to connect the external mic jack of the other device with the H6essential LINE OUT jack.



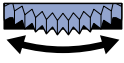

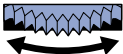
HINT

When output to an external device is unnecessary, disconnecting the cable from the LINE OUT jack can increase the amount of operation time when using batteries.

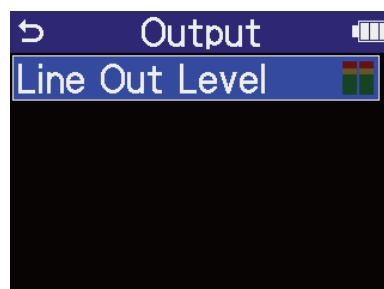
3. On the [Home Screen](#), use  to select  (Output) and press . This opens the Output Settings Screen.
4. Use  to select "Line Out Level" and press .

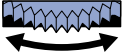

5. Use  to adjust the line out level and press  .
The output level meters can be checked while adjusting.

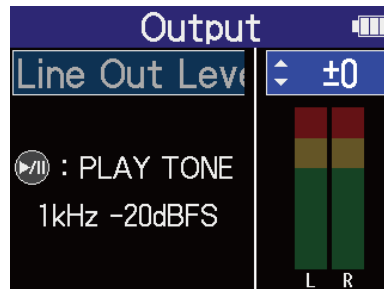

HINT

- This can be set to "Mute" or from -40 to +40.
- Selecting "Mute" silences the output from the LINE OUT jack.

6. To output the test tone from the H6essential and adjust the output level, press  .
While checking the audio level meter of the connected device, adjust the input gain of that device until the audio signal level is about -20 dB.

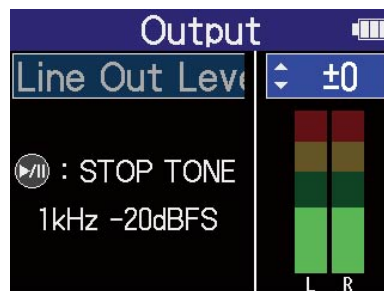

HINT

The test tone is a 1kHz sine wave at -20 dBFS.

7. After adjusting the input gain of the connected device, press  .
This stops test tone output.

NOTE

- See the manual of the connected device for information about its operation.
- If the automatic gain control function on the other device is on, turn it off.
- The level adjusted here does not affect the recorded audio or the audio levels output from the headphone jack or the USB port.

Recording

When recording with the H6essential, every selected track is recorded separately. In addition, all signals are mixed and simultaneously recorded as a stereo file.

The stereo file is recorded with the balance of signals set on the [Mixer Screen](#). (→ [Adjusting the monitoring balance of input sounds](#))

NOTE

- Mixed stereo files will only be created when the sample rate is 44.1 kHz or 48 kHz. Mixed stereo files will not be created when the sample rate is 96 kHz. If you want to create a mixed 96kHz stereo file, use "2Mix" to export it ([Changing the format and exporting files](#)).
- For details about recorded files, see "[H6essential folder and file structure](#)".

Monitoring input sounds

Use headphones, for example, to monitor input sounds and adjust the volume.

1. Connect headphones or another device to the headphone jack.

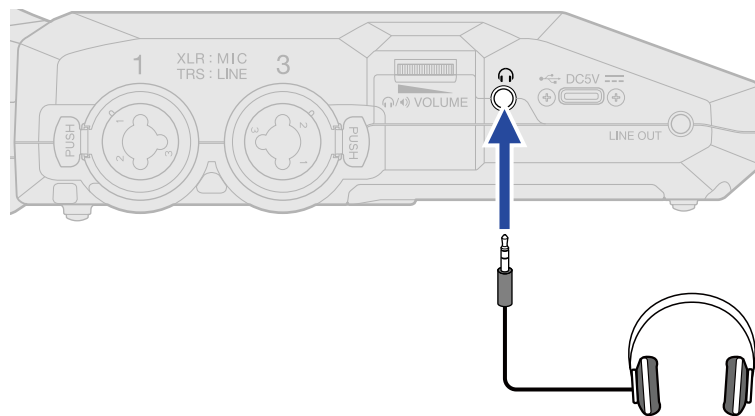

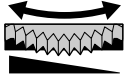
2. Use  to adjust the volume for the headphones or other connected device.
🔊 VOLUME

The volume is shown on the display while the volume is being adjusted.



NOTE

- The volume output from the headphone jack is also affected by volume adjustments made on the [Mixer Screen](#). Adjust the headphone volume after adjusting the input mix levels. (→ [Adjusting the monitoring balance of input sounds](#))
- The built-in speaker cannot be used for monitoring while recording.

HINT

- When monitoring with headphones is unnecessary, disconnecting the headphones from the headphone jack can increase the amount of operation time when using batteries.
 - The volume of each input can also be adjusted separately. (→ [Adjusting the monitoring balance of input sounds](#))
-



Adjusting the monitoring balance of input sounds

On the H6essential [Mixer Screen](#), the monitoring balance of all inputs can be adjusted. Moreover, the volumes of the input sounds and their stereo mix signal can be checked with the level meters. This is a useful function for monitoring multiple inputs sounds with different volumes.



1. Press  when the [Home Screen](#) is open.

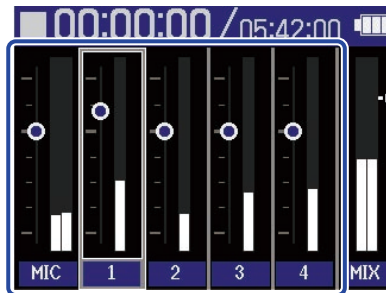

This opens the [Mixer Screen](#).

2. Use  to select the input for which you want to adjust the volume and press .

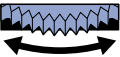



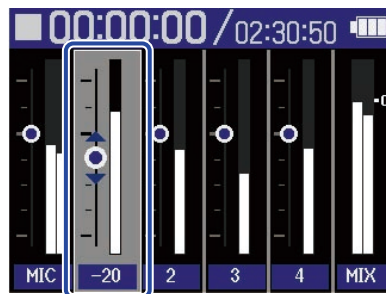



3. Use  to adjust the volume and press .
Confirm the adjusted volume.



4. Repeat steps 2–3 to adjust the overall volume balance.

When done adjusting press  to return to the [Home Screen](#).

NOTE

- The input track buttons ( ,  - ) can be pressed to turn on/off their inputs.
- On the [Mixer Screen](#),  can be used to start recording and  and  can be used to stop it in the same way as on the [Home Screen](#).
- Adjustments on the [Mixer Screen](#) affect the stereo file created with recording. Moreover, these adjustments can also be applied to the recording of each input. (→ [Recording with levels adjusted on the Mixer Screen](#))



HINT



Each input can be set to "Mute" or from -80 to +40.

Making recording settings

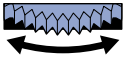
Setting the sample rate

The sample rate used to record files can be set.

1. On the [Home Screen](#), use  to select  (Rec Settings) and press . This opens the Rec Settings Screen.

2. Use  to select "Sample Rate" and press  to confirm.

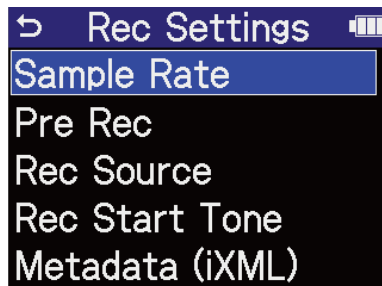

3. Use  to select a sample rate and press  to confirm.

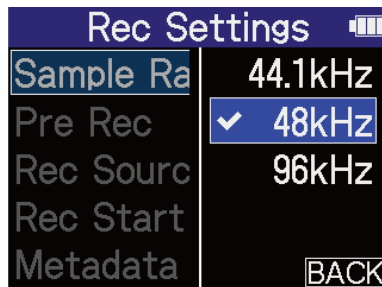

You can select from the following sample rates.

44.1 kHz, 48 kHz, 96 kHz



NOTE



- The only bit depth that can be used for recording is 32-bit float.
- To use the H6essential to record while using it as an audio interface, set the sample rate to 44.1 kHz or 48 kHz. (→ [Using as an audio interface](#))

Capturing audio before recording starts (pre-recording)

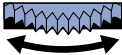

The input signal is always buffered for a set amount of time, so it can be captured (pre-recorded) for up to 2 seconds before the time when  is operated to start recording.

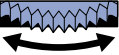
This is useful when  is operated late, for example.

1. On the [Home Screen](#), use  to select  (Rec Settings) and press .
This opens the Rec Settings Screen.

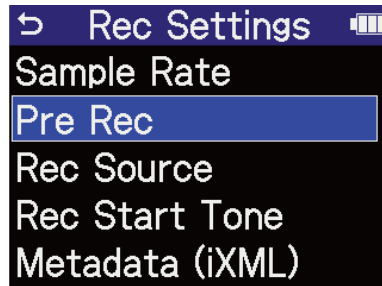
2. Use  to select "Pre Rec" and press  to confirm.

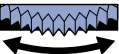

3. Use  to select "On" and press  to confirm.

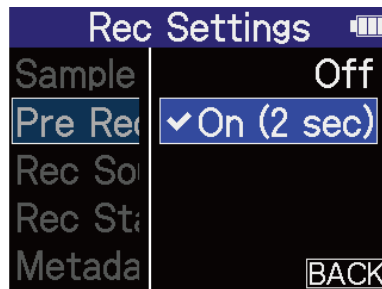





The amount of time that can be pre-recorded when this is set to "On" depends on the sample rate setting (→ [Setting the sample rate](#)).

Sample Rate	Pre-recording time
44.1 kHz	2 seconds
48 kHz	2 seconds
96 kHz	1 second

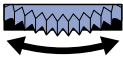

Recording with levels adjusted on the Mixer Screen

When recording, the levels of the sounds as input or the levels as adjusted on the [Mixer Screen](#) can be used.

1. On the [Home Screen](#), use  to select  (Rec Settings) and press .
This opens the Rec Settings Screen.

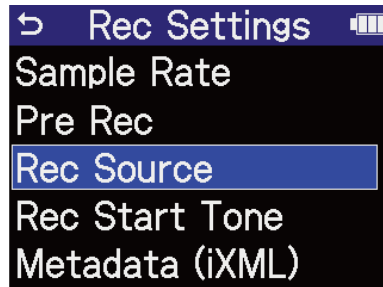
2. Use  to select "Rec Source" and press  to confirm.

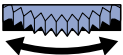

3. Use  to select a setting item, and press  to confirm.

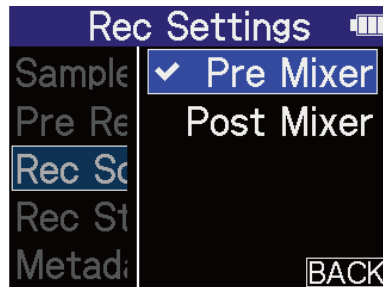



Setting	Explanation
Pre Mixer	Input sound is recorded as is.
Post Mixer	Recording uses the levels adjusted on the Mixer Screen.

Enabling the recording start tone

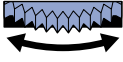

Half-second tone signals (recording start tones) can be output from the output jacks (headphone and LINE OUT jacks) when recording is started.

Since recording start tones are also written to recording files, when recording audio for video with the H6essential, sending its output signal to the camera input can make synchronizing audio and video easier.

1. On the [Home Screen](#), use  to select  (Rec Settings) and press  .
This opens the Rec Settings Screen.

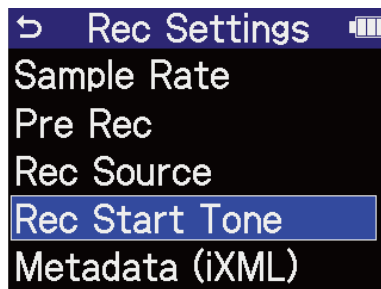
2. Use  to select "Rec Start Tone" and press  to confirm.

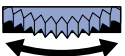

3. Use  to select the recording start tone volume and press  to confirm.

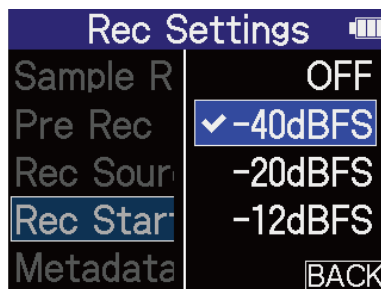

The following volumes can be selected.

OFF, -40 dBFS, -20 dBFS, -12 dBFS, -6 dBFS

No recording start tone will be played if "OFF" is selected.

4. Use a stereo mini jack cable to connect the input jack of the camera to the H6essential LINE OUT jack.

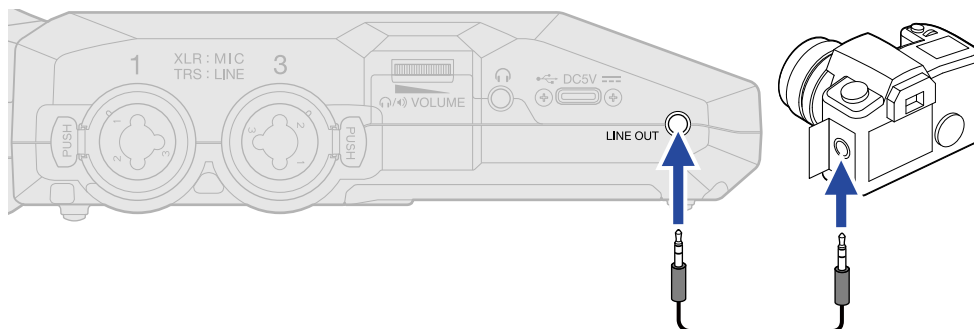



NOTE

Be careful with the volume if you are monitoring the input sound with headphones, for example.

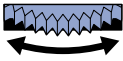

Writing metadata (iXML chunks) to recording files

Various related information (metadata) stored in iXML chunks can be written to recorded files.

1. On the [Home Screen](#), use  to select  (Rec Settings) and press . This opens the Rec Settings Screen.

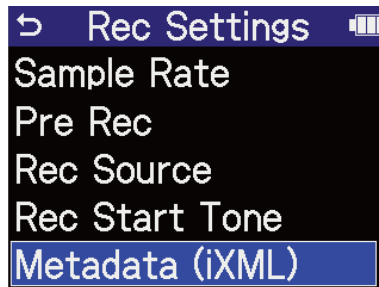
2. Use  to select "Metadata (iXML) and press  to confirm.

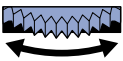

3. Use  to select a setting item, and press  to confirm.

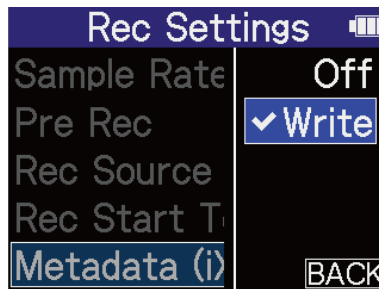



Setting	Explanation
Off	Metadata (iXML chunks) will not be added to recording files.
Write	Metadata (iXML chunks) will be added to recording files.

NOTE

Some applications might not be compatible with files that have data embedded in them. If problems occur with files when using an application, turning off metadata writing might resolve them.

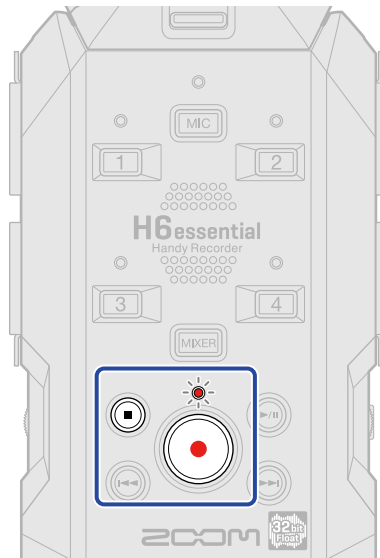
Recording



1. Press  when the Home Screen is open.

The REC indicator will light red, the name of the recording file will appear on the display and recording will start.

This shows the elapsed recording time when recording.

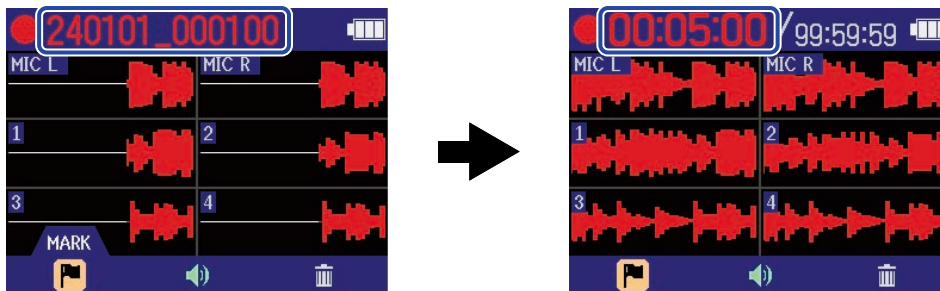

NOTE

The file name will be the date followed by the hour, minute and second using the set date and time ([Setting the date and time](#)). The date will be shown using numbers in the set order ([Setting the date format](#)). For details about file names, see "[Recording file names](#)".

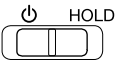

2. Press  or  to stop.

Slide  toward HOLD to prevent misoperation when recording. (→ [Preventing misoperation \(HOLD function\)](#))

NOTE

If the file size exceeds 2 GB during recording, a new file will be created automatically and recording will continue without pause. No gap in sound will occur between the two files when this happens.

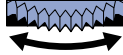

HINT

- Marks can be added while recording by using  to select  (MARK) in the menu bar and pressing . (→ [Adding marks during recording](#))
A maximum of 99 marks can be added in a file.
 - Files are automatically saved at regular intervals during recording. If the power is interrupted or another problem occurs during recording, an affected file can be restored to normal by playing it with the H6essential.
-

Adding marks during recording

Marks can be added to files while recording.

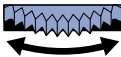
Added marks are shown on the [Playback Screen](#), and ⏮ / ⏭ can be used to move the playback position to a mark.

1. While recording, use  to select  (Mark) in the Menu bar and press . This will add a mark at the position of the current elapsed recording time.

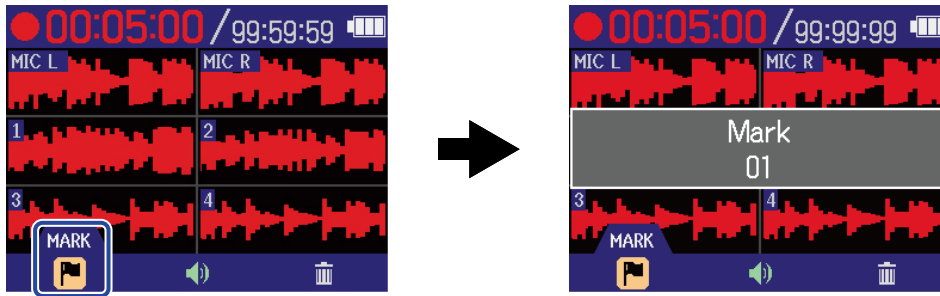

NOTE



A maximum of 99 marks can be added to a single file.

Moving the file being recorded to the TRASH folder

The file being recorded can be moved to the TRASH Folder. This function is convenient when, for example, you feel a recording was not good enough.

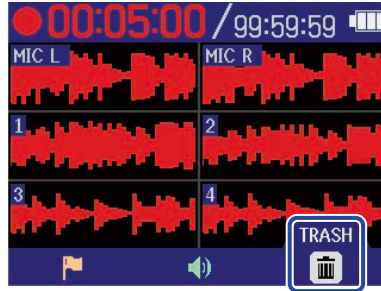
1. While recording, use  to select  (Trash) in the Menu bar and press .

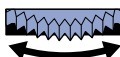

2. Use  to select "Execute" and press .

This will stop recording and move the file being recorded to the TRASH folder. (→ [H6essential folder and file structure](#))



Select "Cancel" and press  to cancel the operation and continue recording.

NOTE

- Files moved to the TRASH folder are saved in the TRASH folder created on the SD card, but their information cannot be checked and they cannot be played back by the H6essential. To check or play them, connect and use a computer, smartphone or tablet. (→ [Transferring files to computers and other devices](#))
- The files in the TRASH folder can all be deleted at the same time. (→ [Deleting files in the TRASH folder](#))

Playing recordings

Playing recordings

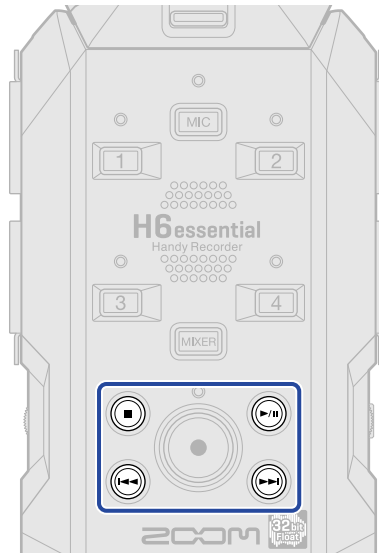

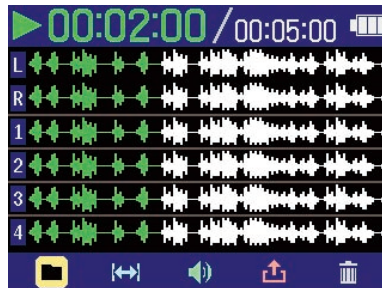

1. Press  when the [Home Screen](#) is open.

This opens the [Playback Screen](#) on the display and starts playback of the most recently recorded file.

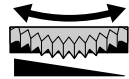

Use  to adjust the headphone or speaker volume. The volume can also be adjusted separately for each track. (→ [Adjusting the volume balance of all tracks](#))

Use  and  to select the playback file.

When the Playback Screen is open, use  to select a menu bar icon and press  to open the corresponding settings screen. (→ [Playback Screen](#))



2. Press .

This stops playback and reopens the [Home Screen](#).

NOTE

On the Playback Screen, all the files in a file folder are treated as one file. For example, if two files named "240101_000000_Tr1.WAV" and "240101_000000_Tr2.WAV" have been created in a file folder, they will be shown as a single file named "240101_000000" on the File List Screen. If this file is selected and moved to the TRASH folder, this operation will be applied to all files in the file folder. (→ [H6essential folder and file structure](#))

HINT



Playing tracks can be turned on/off by pressing their track buttons ( ,  - ). Tracks that have their status indicators lit will be played back. This operation is only available for tracks that have been recorded.

Adjusting the volume balance of all tracks



1. Press  on the [Playback Screen](#).



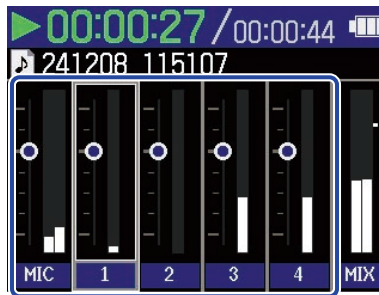

This opens the [Mixer Screen](#).

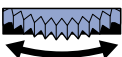
2. Use  to select the track for which you want to adjust the volume and press .



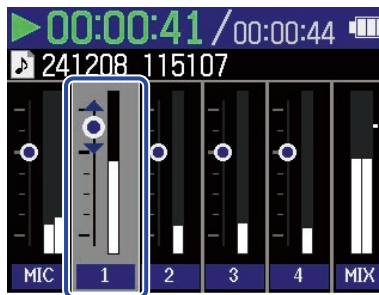





3. Use  to adjust the volume and press .
Confirm the adjusted volume.





4. Repeat steps 2-3 to adjust the overall volume balance.
When done adjusting press  to return to the [Playback Screen](#).



NOTE

- The track buttons ( ,  - ) can be pressed to turn on/off those tracks.
- On the [Mixer Screen](#), in the same way as on the [Playback Screen](#), use  ,  and  to conduct operations.
- Press  to return to the [Home Screen](#).
- Volume adjustments made on the Mixer Screen can be applied to files created when exporting. (→ [Changing the format and exporting files](#))

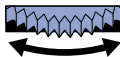

Adjusting the line output level

The line level output during playback to other devices can be adjusted.

1. On the [Playback Screen](#), use  to select  (Output) and press . This opens the Output Settings Screen.

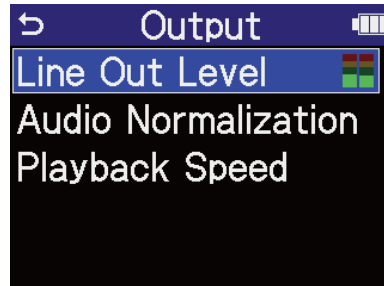
2. Use  to select "Line Out Level" and press .

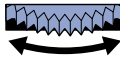

3. Use  to adjust the output level and press . The output level meters can be checked while adjusting.

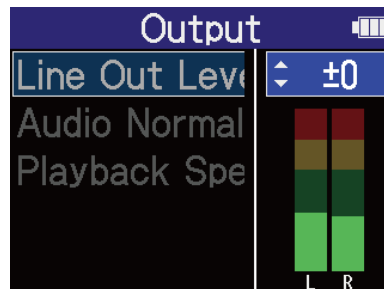

NOTE



The level adjusted here does not affect the recorded audio or the audio level output from the headphone jack.



HINT

- This can be set to "Mute" or from -40 to +40.
- Selecting "Mute" silences the output from the LINE OUT jack.

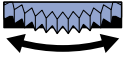
Automatic volume adjustment during playback

By setting "Audio Normalization" to "On", the playback volume can be evened out regardless of recording levels.

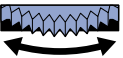
1. On the [Playback Screen](#), use  to select  (Output) and press . This opens the Output Settings Screen.

2. Use  to select "Audio Normalization" and press .

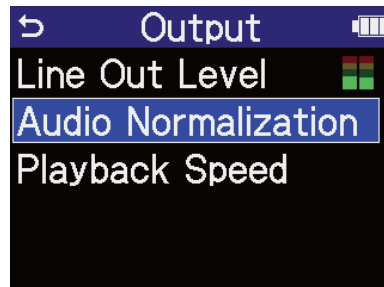

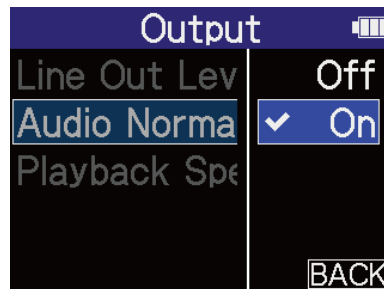

3. Use  to select "ON" and press .



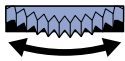

Changing the playback speed

The playback speed can be changed.

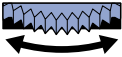
1. On the [Playback Screen](#), use  to select  (Output) and press  .
This opens the Output Settings Screen.

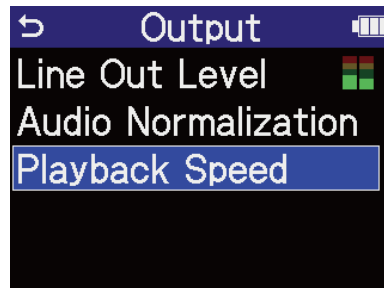
2. Use  to select "Playback Speed" and press  .

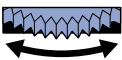

3. Use  to select the playback speed and press  .

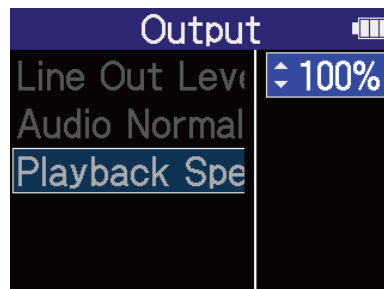



The following speeds can be selected.

50% (half speed), 75%, 100% (normal), 125%, 150%, 200% (double speed)

Repeat playback of a set interval (A-B repeat)



Playback can be repeated between two set points.

1. On the Playback Screen, use  to select  (A-B Repeat) and press .



2. Use  to set the A point (playback starting point) and press .

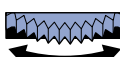

Pressing  confirms the A point and the A marker becomes blue.

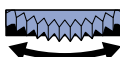

3. Use  to select the B point and press .



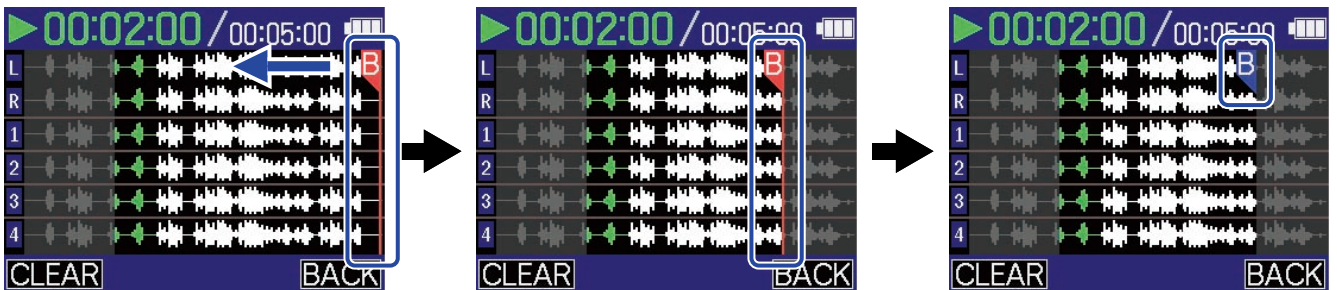

4. Use  to set the B (playback ending point) and press .

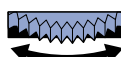

• To change these settings, repeat steps 2 - 4.

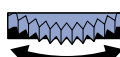
• When A or B is shown in blue, use  to select **CLEAR** and press  to clear the set point.

5. When done making settings, use  to select **BACK** and press .



This reopens the [Playback Screen](#).

NOTE

The interval specified using the A-B Repeat function can be applied when exporting. (→ [Changing the format and exporting files](#))

HINT



Since the A (playback start) and B (playback end) points can be moved during playback, changing the playback start and end positions, they can be set while checking the playback sound.

Changing the format and exporting files

The H6essential can only record using 32-bit float format, but recorded files can be converted to other formats and exported.

This is convenient, for example, when loading files recorded on the H6essential to a computer, smartphone or tablet if the application being used does not support 32-bit float format.

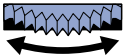
In addition, the exported tracks can be selected and trimmed to only the necessary parts as well as normalized to optimize the volume of the recorded files.

1. On the [Playback Screen](#), use  to select  (Export) and press . This opens the Export Screen.



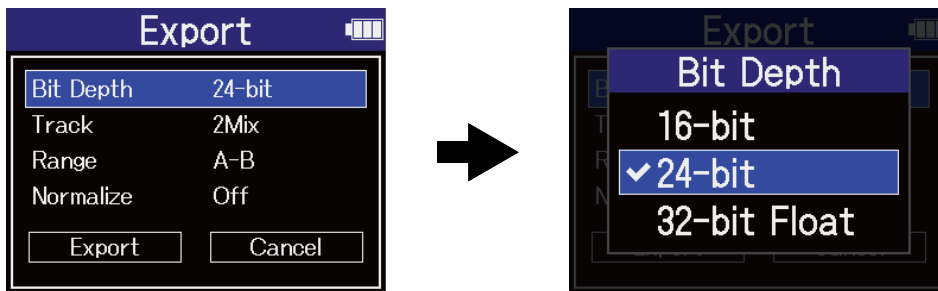

2. Select the bit depth.

Use  to select "Bit Depth" and press . Then, use  to select the format and press .

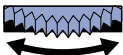

The following formats can be selected.
16-bit, 24-bit, 32-bit Float



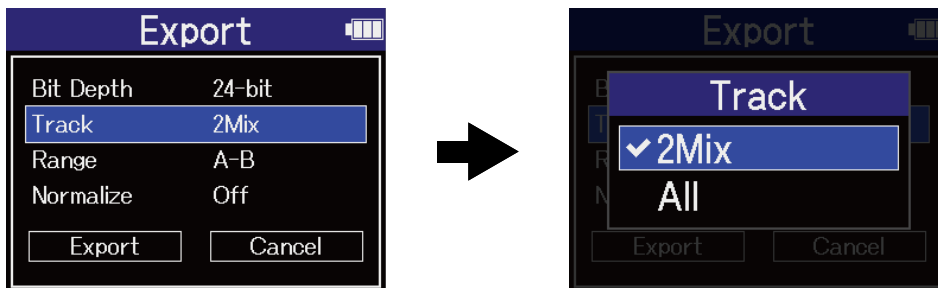

3. Select the tracks to export.

Use  to select "Track" and press . Then, use  to select the tracks to export and press .



Setting	Explanation
2Mix	This exports a stereo file that uses the mix balance adjusted on the Mixer Screen . (→ Adjusting the volume balance of all tracks)
All	This exports all the tracks separately.

4. Select whether or not to export using a specified range.

Use  to select "Range" and press . Then, use  to select the setting and press .

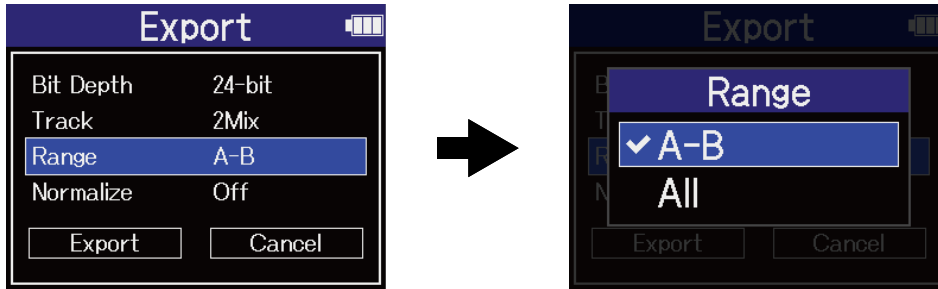

Setting	Explanation
A-B	This exports the range between the two points set using Repeat playback of a set interval (A-B repeat) .
All	This export the entire track.

5. Select whether or not to normalize.

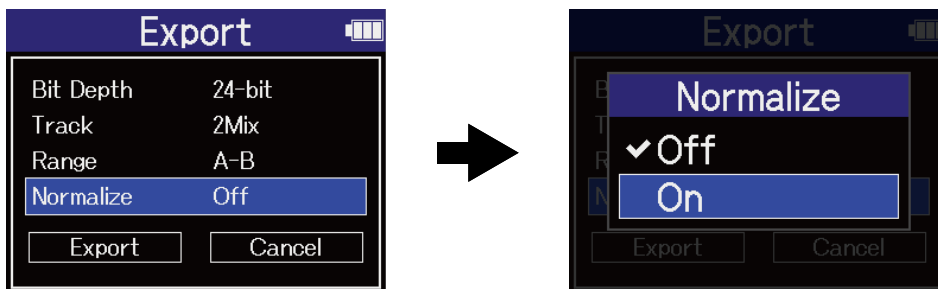

Use  to select "Normalize" and press . Then, use  to select "On" or "Off" and press .





If "On" is selected, the file will be normalized during export.

NOTE

Normalization is a function that reads the maximum volume of the audio data and levels the volume without causing distortion. The volume is adjusted to the maximum possible without causing the loudest sound (peak) in the data to distort.

6. When done making settings, use  to select "Export" and press .

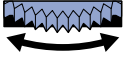

7. Use  to select "Execute" and press .



The exported file will be saved in the Export folder. (→ [H6essential folder and file structure](#))



Select "Cancel" and press  to cancel the operation and return to the original screen.

NOTE

- Exported files saved in the Export folder are named in this format: FF_BB_NN_track name.WAV.
 - FF: Name of the file folder that holds the exported file
 - BB: Bit depth ("16" when 16-bit selected, "24" when 24-bit selected or nothing when 32-bit float selected)
 - NN: Normalization setting ("NORM" when on or nothing when off)
- The H6essential cannot play files in the Export folder.

Moving the file being played to the TRASH folder

The file being played can be moved to the TRASH Folder.

1. When the [Playback Screen](#) is open, use  to select  in the Menu bar and press .

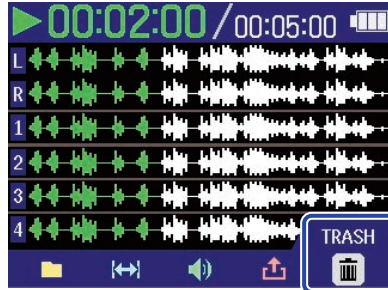

2. Use  to select "Execute" and press .

This moves the file being played to the TRASH folder. (→ [H6essential folder and file structure](#))



Select "Cancel" and press  to cancel the operation.

NOTE

- Files moved to the TRASH folder are saved there, but their information cannot be checked and they cannot be played back by the H6essential. To check or play them, connect and use a computer, smartphone or tablet. (→ [Transferring files to computers and other devices](#))
- Be aware that all files in the file folder will be moved to the TRASH folder. (→ [H6essential folder and file structure](#))
- The files in the TRASH folder can all be deleted at the same time. (→ [Deleting files in the TRASH folder](#))

Managing files

Files created on the H6essential will be saved on the microSD card.
Recording files on the microSD card can be checked and deleted.

H6essential folder and file structure

Folder and file structure

When recording with the H6essential, files are created on microSD cards in the following manner.

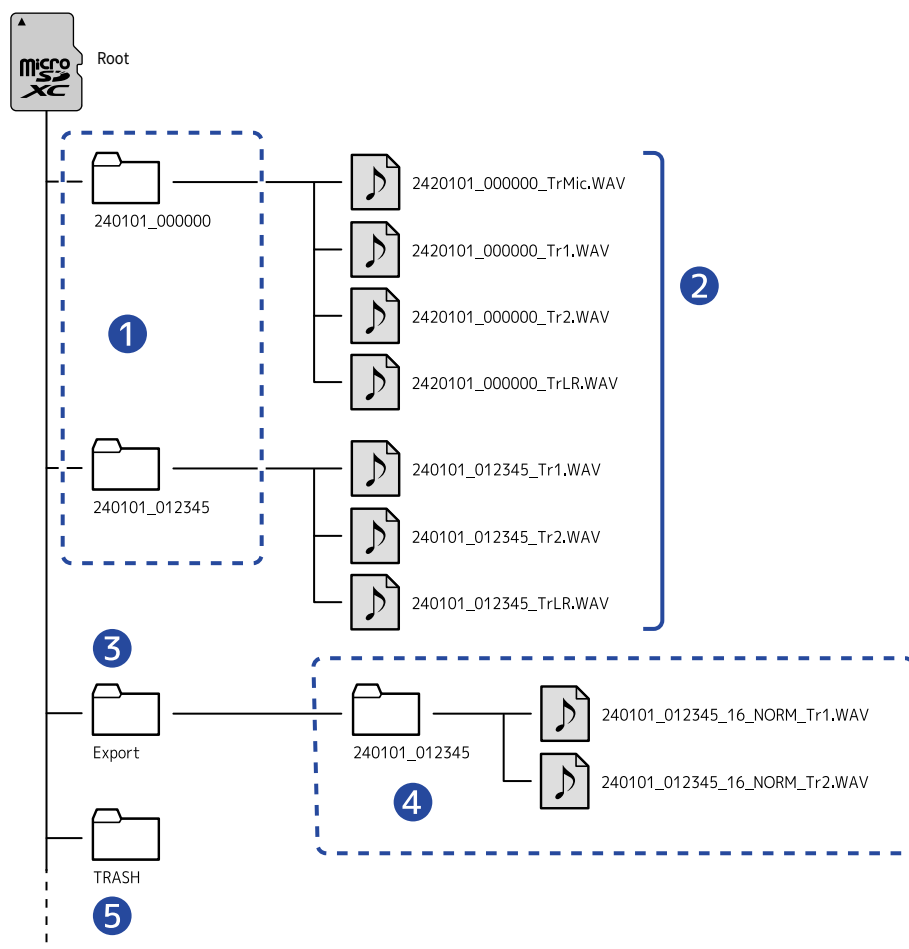

1 File folders

These are created each time recording is conducted. File folders are named in this format: Date_Time. Mono and stereo files that are created are saved in them.

2 Recording files

Files recorded by the H6essential are saved in file folders on the microSD card. For details about recording file names, see ["Recording file names"](#).

- The files for each track along with the stereo file that is a mix of all tracks are saved here.

- Stereo files will be created if the MIC (mic capsule) “Mono Mix” setting is “Off” or if inputs 1/2 or 3/4 are stereo linked. Mono files will be created in other cases. (→ [Converting mic capsule input to mono](#), [Enabling stereo linking](#))

3 Export folder

This is created when files are exported. Files created by exporting are saved in the Export folder. (→ [Changing the format and exporting files](#))

4 Exported files

Files created by exporting are saved in a subfolder with the same name inside the Export folder. (→ [Changing the format and exporting files](#))

5 TRASH folder

The TRASH folder is created automatically when an SD card is loaded in the H6essential. Files that have been moved to the TRASH folder are saved inside it. (→ [Moving the file being recorded to the TRASH folder](#), [Moving the file being played to the TRASH folder](#))

The files in the TRASH folder can all be deleted at the same time. (→ [Deleting files in the TRASH folder](#))

Recording file names

Files are named with the following format.

File name example	Explanation
<u>2420101</u> _ <u>000000</u> _ <u>Tr1</u> .WAV 1 2 3	<ol style="list-style-type: none">1 Date The date of recording is included numerically. The numbers follow the set order (Setting the date format).2 Time The hour, minute and second are included numerically.3 Track name This shows the track used for recording.<ul style="list-style-type: none">• TrMic: File recorded using the mic capsule• Tr1–Tr4: Files recorded using tracks 1–4• TrLR: File that is a stereo mix of all tracks



NOTE

- If the file size exceeds 2 GB, new files and a new file folder will be created automatically and recording will continue without pause. New files and file folders created this way will be named using the numerical date and time of the moment of continuation.
- Files that are stereo mixes of all tracks will only be created when the sample rate is set to 44.1 kHz or 48 kHz. (→ [Setting the sample rate](#))

Checking files

On the [File List Screen](#), files on the microSD card can be checked while playing them.

When the Menu bar is open, the [Playback Screen](#) can be opened for the selected file and that file can also be moved to the TRASH folder.

1. When the [Home Screen](#) or [Playback Screen](#) is open, use  to select  (File List) and press .

This opens the [File List Screen](#), which list the files on the microSD card.

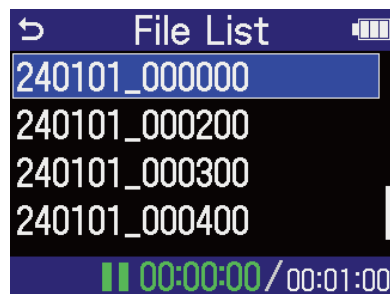

2. Use  to select a file and press .

A menu bar that enables operations on the selected file will appear.



Use  to select the settings item and press  to open the settings screen. (→ [File List Screen](#))

NOTE

On the [File List Screen](#), all the files inside a file folder are handled as a single file. For example, if two files named "240101_000000_Tr1.WAV" and "240101_000000_Tr2.WAV" have been created in a file folder, they will be shown as a single file named "240101_000000" on the File List Screen. If this file is selected and moved to the TRASH folder, this operation will be applied to all files in the file folder. (→ [H6essential folder and file structure](#))

HINT

Press  to return to the Home Screen. (→ [Home Screen](#))

Using as an audio interface

Signals input to the H6essential can be sent to a computer, smartphone or tablet, and playback signals from that device can be output from the H6essential.

Moreover, the H6essential can record even when it is being used as an audio interface.

No driver is necessary for use with smartphones, tablets or Mac computers.

A driver is necessary for use with Windows computers.

For Windows

1. Download the H6essential Driver to the computer from zoomcorp.com.

NOTE

The latest H6essential Driver can be downloaded from the above website.

2. Launch the installer and follow the instructions to install the H6essential Driver.

NOTE

See the Installation Guide included in the driver package for detailed installation procedures.

Connecting to computers, smartphones and tablets

1. Use a USB (Type-C) cable to connect the H6essential with a computer, smartphone or tablet.

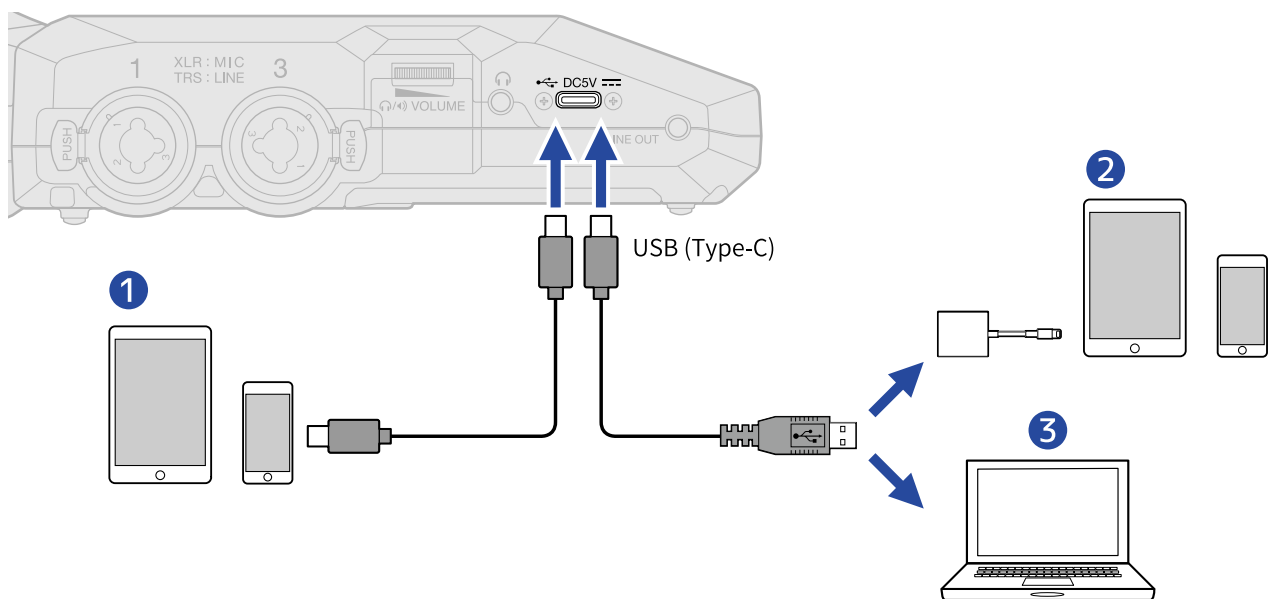



- 1 Smartphone/tablet (USB Type-C)



2 Smartphone/tablet (Lightning)

3 Computer (Windows/Mac)

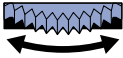
NOTE



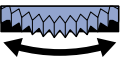

- Use a USB cable that supports data transfer.
- A Lightning to USB 3 Camera Adapter is necessary to connect to an iOS/iPadOS device with a Lightning connector.

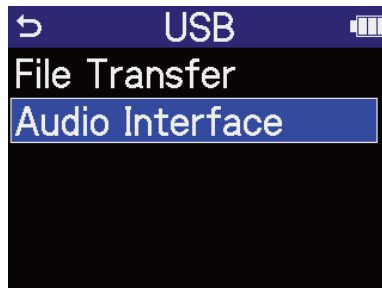
2. On the Home Screen, use  to select  (USB) and press  .
The USB screen will open.

3. Use  to select "Audio Interface" and press  to confirm.





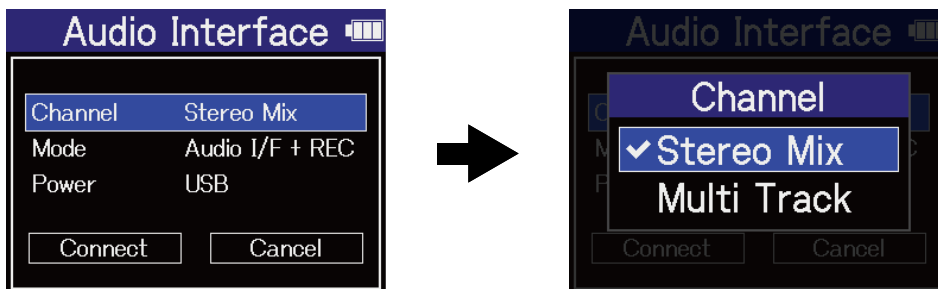

4. Set the channels to output to the computer, smartphone or tablet.

Use  to select "Channel" and press  . Then, use  to select the channels and press  .



Setting	Explanation
Stereo mix	All inputs are combined in a stereo mix using volumes adjusted on the <u>Mixer Screen</u> and two channels are output to the computer, smartphone or tablet. (→ <u>Adjusting the monitoring balance of input sounds</u>)
Multi Track	This will output 6 channels with each input separately to the computer, smartphone or tablet.

5. Set whether to record simultaneously with the H6essential.

Use  to select "Mode" and press . Then, use  to select the mode and press .

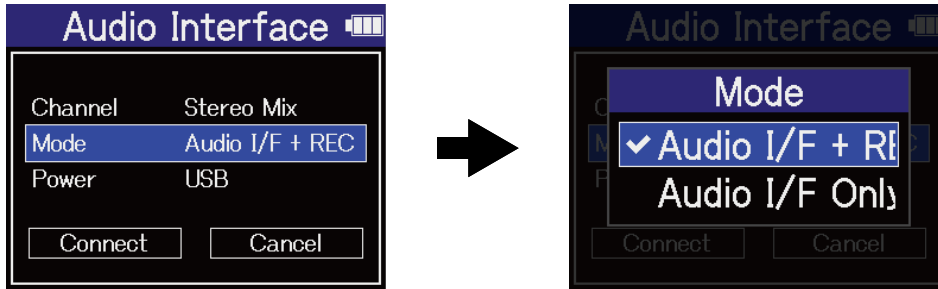





Setting	Explanation
Audio I/F + REC	The H6essential can record and play back even when it is being used as an audio interface. For details about this function, see " Recording on the H6essential while using it as an audio interface ".
Audio I/F Only	The H6essential will not record or play back when it is being used as an audio interface.

NOTE

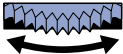
- "Audio I/F + REC" can be selected only when the sample rate is set to 44.1 kHz or 48 kHz. (→ [Setting the sample rate](#))
- All sample rate options can be used when "Audio I/F Only" is selected. The sample rate, which can be set from the computer, smartphone or tablet, has 44.1 kHz, 48 kHz and 96 kHz options.

6. Select the power supply.

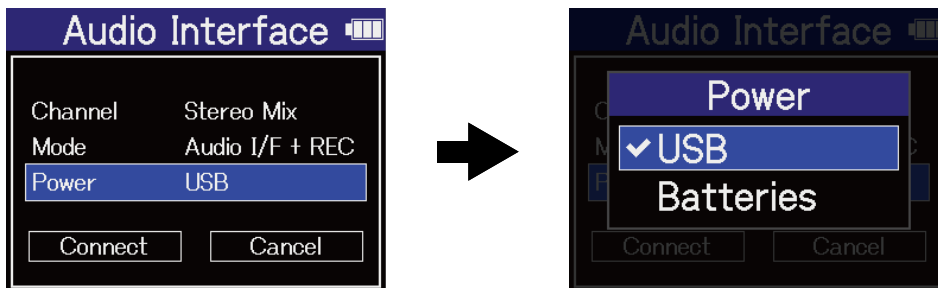

Use  to select "Power" and press . Then, use  to select the power supply and press .



Setting	Explanation
USB	Power will be supplied using USB bus power.
Batteries	The batteries in the unit will be used.

NOTE

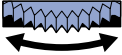
- When “USB” is selected, power is supplied through the USB cable from the computer. Depending on the USB bus power supply capacity of the computer, operation using bus power might not be possible. If this is the case, select “Batteries” and operate using batteries when connected.
- When “Batteries” is selected, power will not be supplied from the other device. Instead, the H6essential will operate using the batteries in it.

7. Use  to select “Connect” and press  to confirm.
Connect with the computer, smartphone or tablet.



8. Launch an application on the computer, smartphone or tablet, and select “H6essential” as the “Audio” or “Input/Output” device.

NOTE

- If “H6essential” cannot be selected for the “Sound” setting on a computer, by selecting “H6essential” as the “Audio” or “Input/Output” device in an application that supports 32-bit float format, it can be used as a 32-bit float audio interface.
- See the application operation manuals for information about their operation.

Making input settings and monitoring adjustments

When using the H6essential an audio interface, input settings and monitoring adjustments can be made in the same way as when using it as a recorder.

See the references below and make input settings and monitoring adjustments.

Reference	Explanation
Enabling tracks for recording	Select inputs from MIC (mic capsule) and inputs 1–4.
Converting mic capsule input to mono	Mic capsule input can be mixed to a single channel and handled as mono audio.
Setting phantom power	Inputs 1–4 support phantom power and can provide +48 V. Turn on phantom power when condenser mics that require it are connected. This can be turned on/off separately for each input.
Reducing noise (Lo Cut)	Low frequencies can be cut to reduce the sound of wind and vocal pop noises, for example. This can be set separately for each input.
Enabling stereo linking	Using stereo-linking, input signals can also be handled as stereo audio. When the stereo setting is used, the odd track will become the left channel and the even track will become the right channel. When the mid-side stereo setting is used, the odd track will become the Mid signal and the even track will become the Side signal. Mid captures sound front and center while Side captures sound left and right. The stereo width can be changed by adjusting the Side level.
Setting the side level when recording mid-side stereo	The side level of inputs set to mid-side stereo can be set before recording, allowing the stereo width of that input sound to be adjusted.
Monitoring input sounds	Use headphones, for example, to monitor input sounds and adjust the volume.
Adjusting the monitoring balance of input sounds	On the Mixer Screen , the monitoring balance of all input sounds can be adjusted. Moreover, the volumes of the input sounds and their stereo mix signal can be checked with the level meters.

Making output settings

Adjusting the line output level

The line output level used for output from the LINE OUT jack to other devices during use as an audio interface can be adjusted.



For operation details, see "[Adjusting the line output level](#)".

NOTE

This does not affect the recorded audio or the audio levels output from the headphone jack or the USB port.

Adjusting the USB output level

The level output by USB to the computer, smartphone or tablet can be adjusted.

1. On the [Home Screen](#) when in audio interface mode, use  to select  (Output) and press



This opens the Output Settings Screen.

2. Use  to select "USB Out Level" and press .

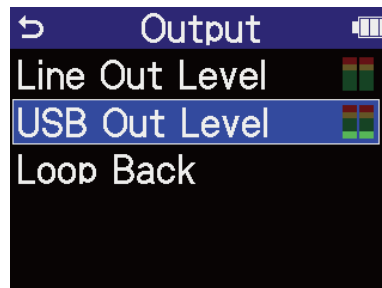

3. Use  to adjust the USB output level and press .

The output level meters can be checked while adjusting.

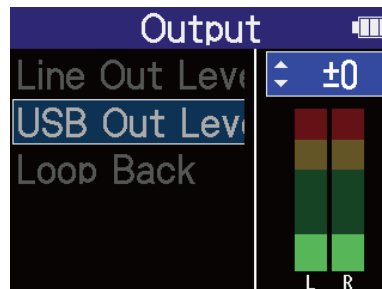

NOTE



This setting does not affect the recorded audio or the audio levels output from the headphone jack or the LINE OUT port.



HINT

- This can be set to "Mute" or from -40 to +40.
 - Selecting "Mute" silences the output from the USB port.
-

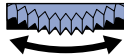

Enabling the loop back function

This function allows the playback sound from the computer, smartphone or tablet and the sounds input to the H6essential to be mixed and sent again (looped back) to the computer, smartphone or tablet. This function can be used to add narration to music played back from a computer and to record the mix or stream it on that computer, for example.

- 1.** On the [Home Screen](#) when in audio interface mode, use  to select  (Output) and press . This opens the Output Settings Screen.

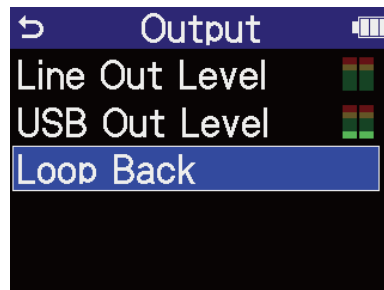
- 2.** Use  to select "Loop Back" and press .

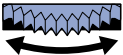

- 3.** Use  to select On or Off, and press . Selecting "On" turns on the loop back function.

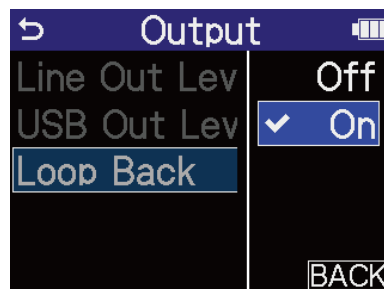

Recording on the H6essential while using it as an audio interface

As explained in "[Connecting to computers, smartphones and tablets](#)", if the Mode is set to "Audio I/F + REC" the H6essential can record while it is being used as an audio interface. In this case, recording settings can be made in the same way as when using it as a recorder. See the references below and make recording settings.

Reference	Explanation
Capturing audio before recording starts (pre-recording)	The input signal is always buffered for a set amount of time, so it can be captured (pre-recorded) for up to 2 seconds before the time when  is operated to start recording.
Recording with levels adjusted on the Mixer Screen	When recording, the levels of the sounds as input or the levels as adjusted on the Mixer Screen can be used.
Enabling the recording start tone	Half-second tone signals (recording start tones) can be output from the output jacks (headphone and LINE OUT jacks) when recording is started.
Writing metadata (iXML chunks) to recording files	Various related information (metadata) stored in iXML chunks can be written to recorded files.

NOTE

As explained in "[Connecting to computers, smartphones and tablets](#)", when the mode is set to "Audio I/F + REC" the sample rate of the H6essential cannot be changed. To change the sample rate, disconnect the computer, smartphone or tablet and follow the instructions in "[Setting the sample rate](#)".

HINT

Press  to open the [Playback Screen](#) where recorded files can be played back. (→ [Playing recordings](#))

Disconnecting from computers, smartphones and tablets

1. On the Home Screen, use  to select  (EXIT) and press .

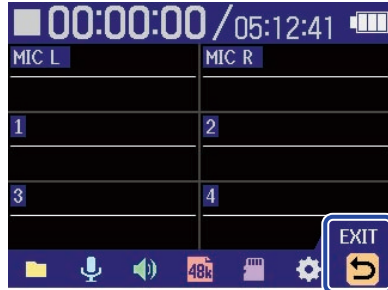

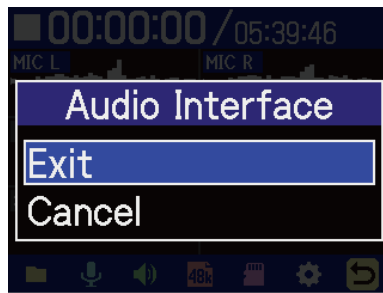

2. Use  to select "Exit" and press .



Transferring files to computers and other devices

By connecting the H6essential with a computer, smartphone or tablet, files on the microSD card can be checked and moved.

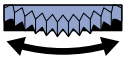
Connecting to computers, smartphones and tablets

1. On the [Home Screen](#), use  to select  (USB) and press . The USB screen will open.

2. Use  to select "File Transfer" and press  to confirm.

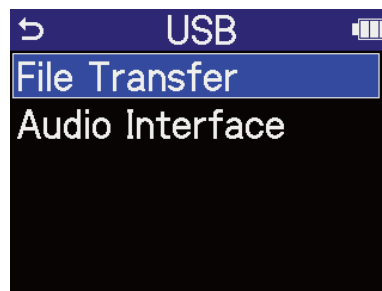

3. Use  to select the type of device to connect and press  to confirm.

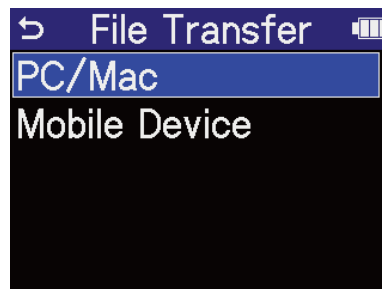

Setting	Explanation
PC/Mac	Connect to a computer.
Mobile Device	Connect to a smartphone or tablet.

This opens the File Transfer Screen.

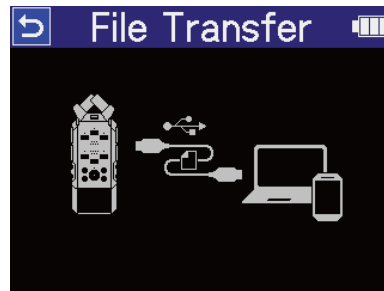

NOTE

- When “PC/Mac” is selected, power is supplied through the USB cable from the computer. Depending on the USB bus power supply capacity of the computer, operation using bus power might not be possible. If this is the case, select “Mobile Device” to operate using batteries.
- When “Mobile Device” is selected, power will not be supplied from the other device. Instead, the H6essential will operate using the batteries in it.

4. Use a USB (Type-C) cable to connect the H6essential with a computer, smartphone or tablet.

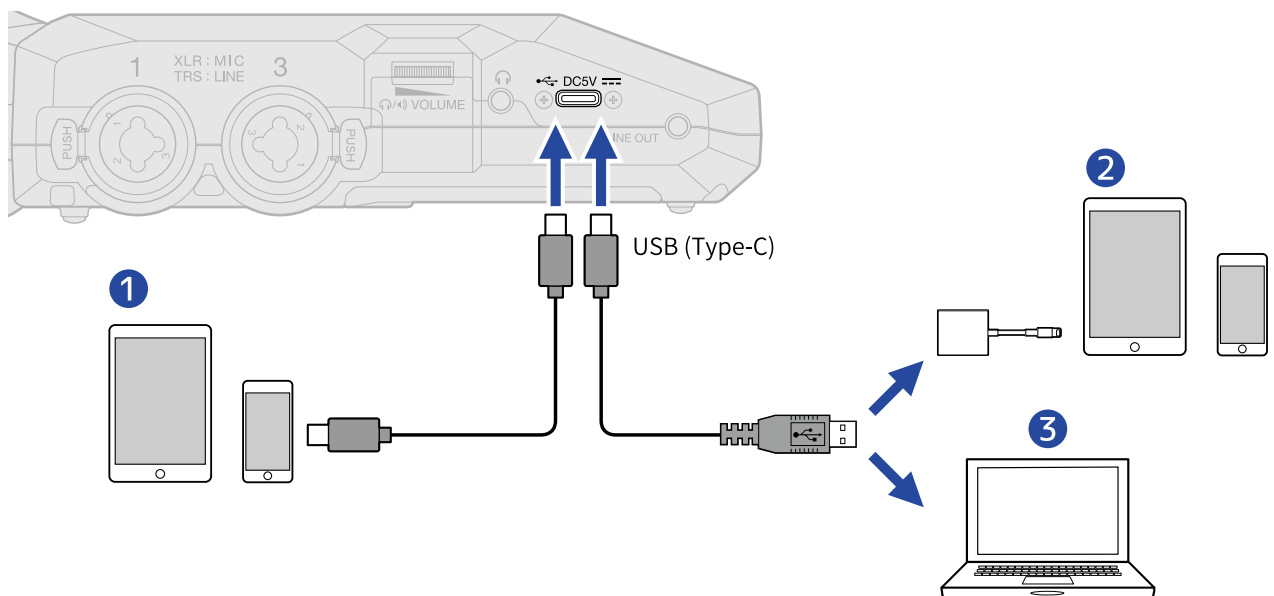

- 1 Smartphone/tablet (USB Type-C)
- 2 Smartphone/tablet (Lightning)
- 3 Computer (Windows/Mac)

NOTE

- Use a USB cable that supports data transfer.
- A Lightning to USB 3 Camera Adapter is necessary to connect to an iOS/iPadOS device with a Lightning connector.

5. Use the computer, smartphone or tablet to work with the files saved on the microSD card.



Disconnecting from computers, smartphones and tablets

1. Conduct disconnection procedures on the computer, smartphone or tablet.

- Windows:
Select the H6essential from "Safely Remove Hardware".
- macOS:
Drag the H6essential icon to the Trash and drop it.
- Smartphone/tablet:
See the operation manual for the device.

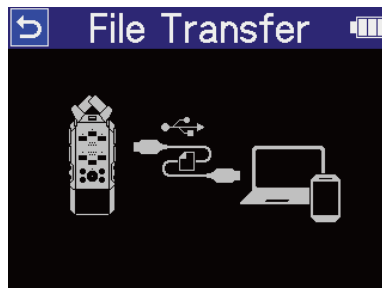
2. Press .

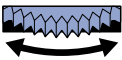

3. Use  to select "Exit" and press  to confirm.

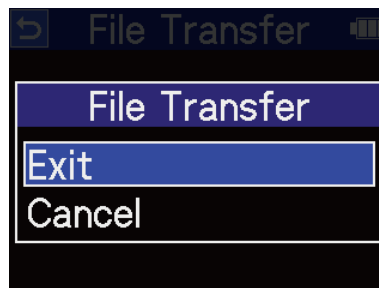





The [Home Screen](#) will reopen.

Managing microSD cards

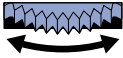

Formatting microSD cards

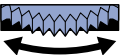
To maximize the performance of a microSD card, use the H6essential to format it.

1. On the Home Screen, use  to select  (SD card) and press . The SD Card screen will open.

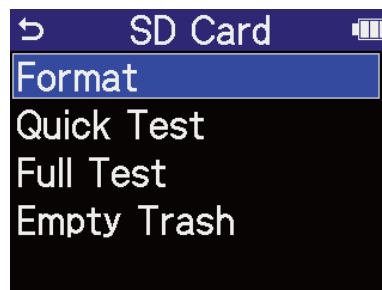
2. Use  to select "Format" and press .

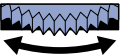

3. Use  to select "Execute" and press .

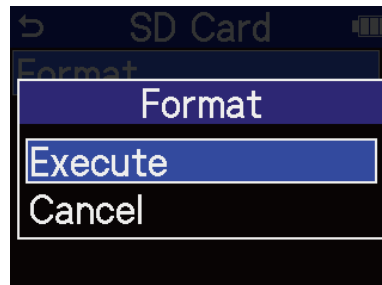

This formats the microSD card.

NOTE



- The microSD card formatting screen can also be opened by pressing  while turning the power on.
- Always format microSD cards in order to maximize their performance after purchasing them new or using them with a different device.
- Be aware that all data on the microSD card will be deleted when it is formatted.



Testing microSD cards

The writing speed of microSD cards can be tested to check if performance is good enough to save the data recorded by the H6essential.

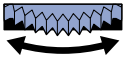

A Quick Test can be done in a short amount of time, while a Full Test examines the entire microSD card.

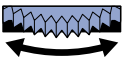
Conducting a quick test

1. On the Home Screen, use  to select  (SD card) and press . The SD Card screen will open.

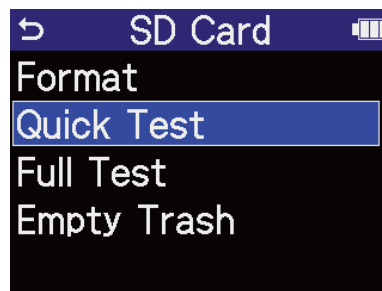
2. Use  to select "Quick Test" and press .

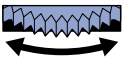

3. Use  to select "Execute" and press . The card performance test will start.

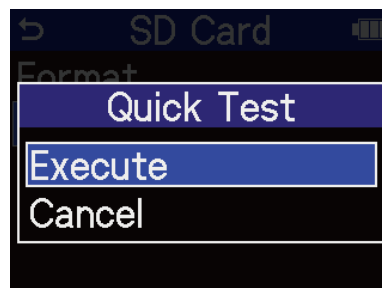

The result of the test will be shown when it completes.

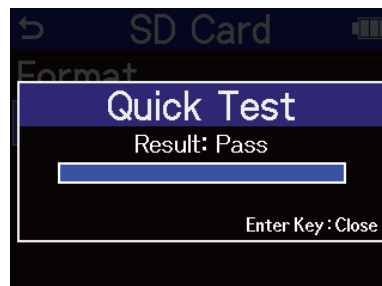



NOTE



Even if a performance test result is "Pass", there is no guarantee that writing errors will not occur. This information is just to provide guidance.

HINT

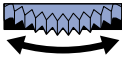
During a test,  can be pressed to stop it.



Conducting a full test

1. On the Home Screen, use  to select  (SD card) and press  .
The SD Card screen will open.

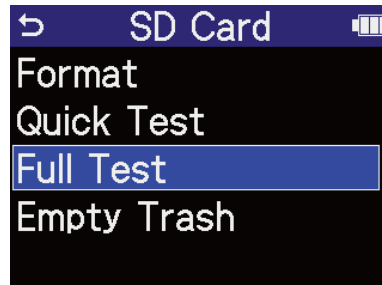
2. Use  to select "Full Test" and press  .

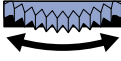

The amount of time required for the full test will be shown.

3. Use  to select "Execute" and press  .
The card performance test will start.

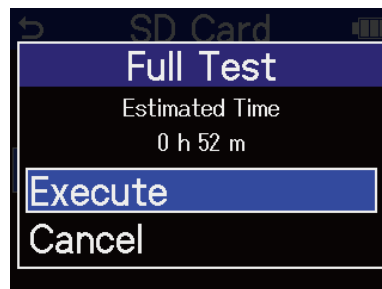

The result of the test will be shown when it completes.
If Access Rate Max. reaches 100%, the card will fail (NG).

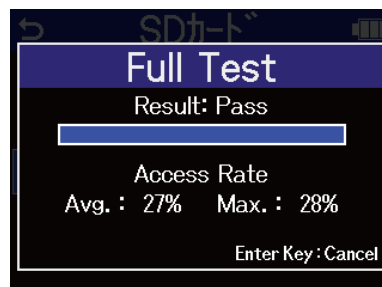

NOTE



Even if a performance test result is "Pass", there is no guarantee that writing errors will not occur. This information is just to provide guidance.



HINT

During a test,  can be pressed to stop it.

Deleting files in the TRASH folder

Files moved to the TRASH folder can be deleted, emptying it.

1. On the Home Screen, use  to select  (SD card) and press  .
The SD Card screen will open.

2. Use  to select "Empty Trash" and press  .

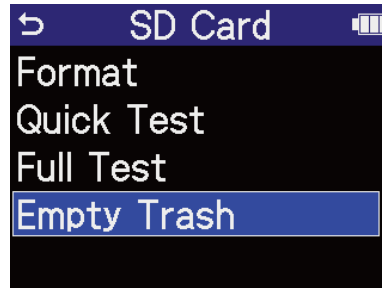

3. Use  to select "Execute" and press  .

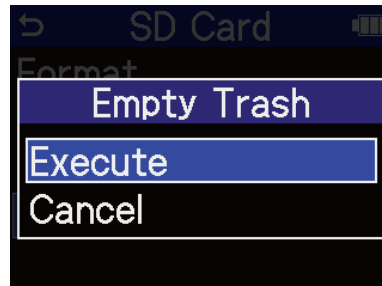

This deletes all files in the TRASH folder.

Using timecode

Timecode overview

SMPT E timecode can be input to the H6essential by using an UltraSync BLUE made by Timecode Systems. Timecode is time information written to data when recording video and audio. It is used for video editing, control of other devices, and synchronization of audio and video, for example.

NOTE

- A Timecode Systems UltraSync BLUE cannot be used during audio interface operation (→ [Using as an audio interface](#)).
- An H6essential cannot have both H6essential Control and an UltraSync BLUE connected at the same time.

Using timecode for editing

If video and audio data both have recorded timecode, aligning them to a timeline and synchronizing them together is easy when using nonlinear editing software for editing.

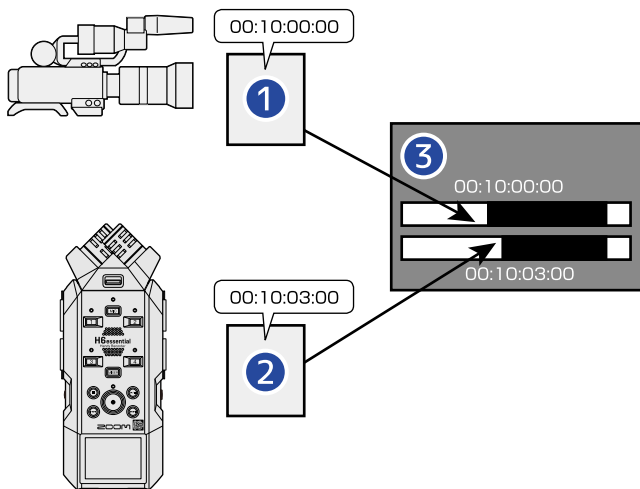

- 1 Video file with timecode recorded
- 2 Audio file with timecode recorded
- 3 Nonlinear editing software

Inputting timecode

The UltraSync BLUE made by Timecode Systems transmits timecode, which is received by both the H6essential and the video camera, resulting in timecode being recorded in both the audio data and video data.

The timecode is transmitted and received by Bluetooth.

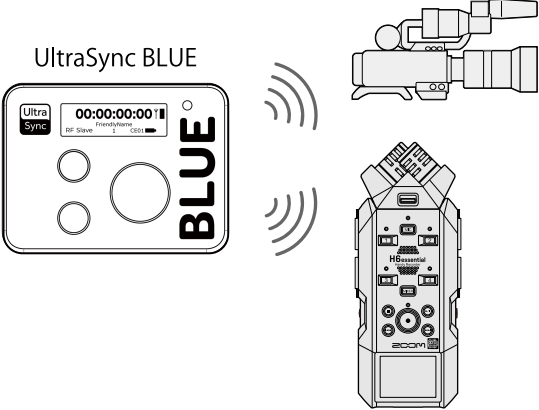



Connecting with an UltraSync BLUE

If the H6essential is connected to an UltraSync BLUE, it can receive timecode from the UltraSync BLUE and add it to recording files.

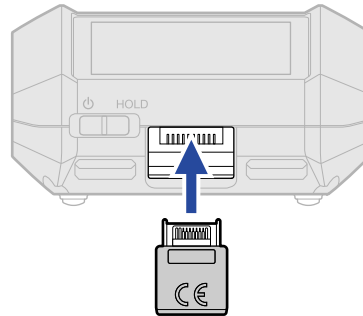

To connect an UltraSync BLUE, a BTA-1 or other dedicated wireless adapter must be connected to the H6essential. Then, the UltraSync BLUE and the H6essential must be paired.

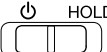
1. With the H6essential power off, remove the REMOTE connector cover on its front. Then, connect a BTA-1 or other dedicated wireless adapter.



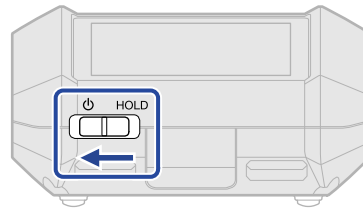

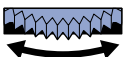
2. Slide  toward  until the display becomes active and the power turns on.

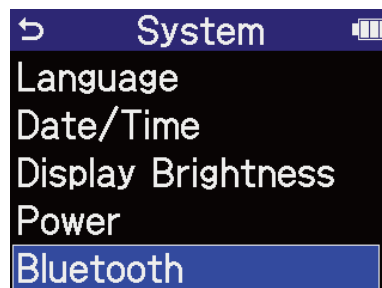

3. On the [Home Screen](#), use  to select  (System) and press . This opens the System Settings Screen.

4. Use  to select "Bluetooth" and press .

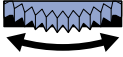

5. Use  to select "Timecode" and press .

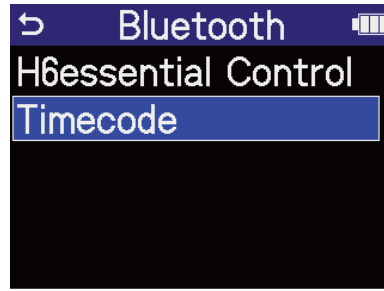

Searching for the device to connect will begin and "Searching" will appear on the display.

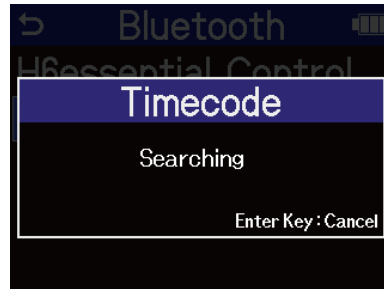

NOTE

If the H6essential and the UltraSync BLUE have been connected, when a screen like the following appears, make a selection.

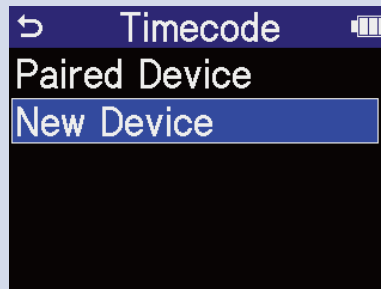

Setting	Explanation
Paired Device	Select this to connect to the UltraSync BLUE that was connected the previous time. In this case, connection will be made with the UltraSync BLUE because its operation described in step 6 becomes unnecessary.
New Device	Select this to connect to a different UltraSync BLUE than the one that was connected the previous time. Selecting "New Device" will erase information about the previously paired device. Proceed to step 6.

HINT

Searching can be canceled by pressing .

6. Operate the UltraSync BLUE and select the H6essential as a connected device.

This starts pairing.

When pairing completes, "Timecode Device Connected!" will appear on the H6essential display.

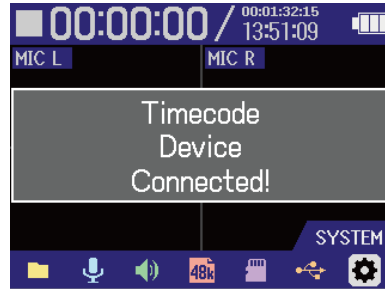

HINT

- See the UltraSync BLUE manual for the procedures to select connected devices.
- Use the H6essential and the UltraSync BLUE as close together as possible to make communication more reliable.
- If communication with the UltraSync BLUE is interrupted while recording, timecode data will not be added to the remainder of the recording.

Checking timecode data

While timecode is being received from an UltraSync BLUE, timecode data can be checked on the [Home Screen](#).

The timecode appears above the recordable time on the [Home Screen](#) as the hour, minute, second and frame.

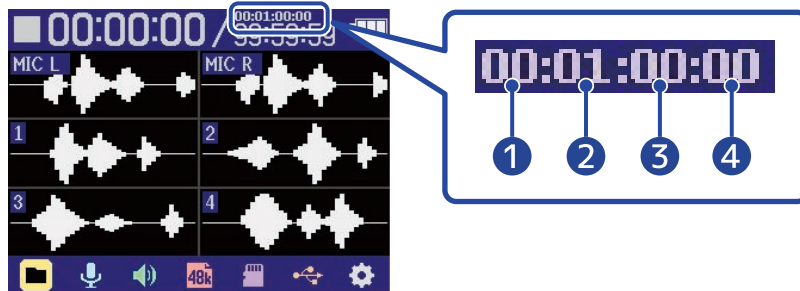

- 1 Hour
- 2 Minute
- 3 Second
- 4 Frame



Disconnecting from an UltraSync BLUE



Removing the BTA-1 from the H6essential will disconnect the H6essential from the UltraSync BLUE and stop timecode recording. Pairing information will be retained even when disconnected.

Making various settings

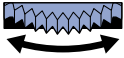

Setting the language shown

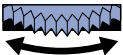
The language shown on the H6essential screens can be changed.

1. On the [Home Screen](#), use  to select  (System) and press . This opens the System Settings Screen.

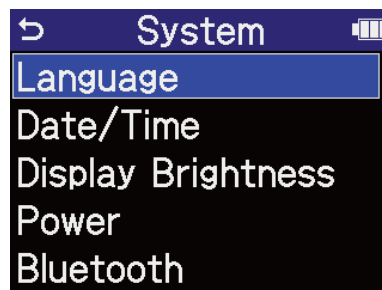
2. Use  to select "Language" and press .

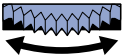

3. Use  to select the language you want shown and press .

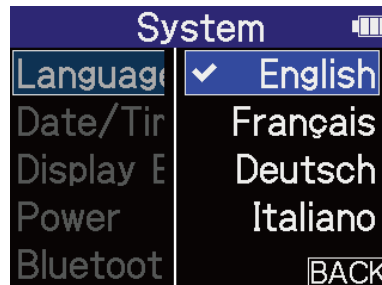



HINT

The first time you turn the power on after purchase or restoring default settings, this screen opens automatically after setting the guide sound.

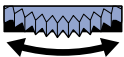

Setting the date and time

Use this to set the date and time added to recording files.

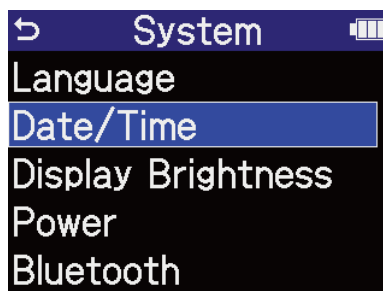

1. On the [Home Screen](#), use  to select  (System) and press . This opens the System Settings Screen.

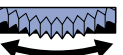
2. Use  to select "Date/Time" and press .



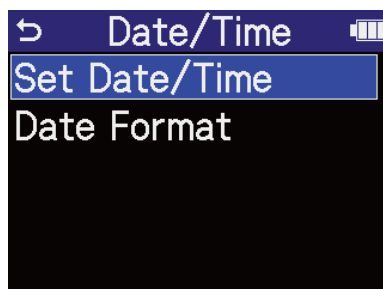

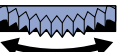
3. Use  to select "Set Date/Time" and press .



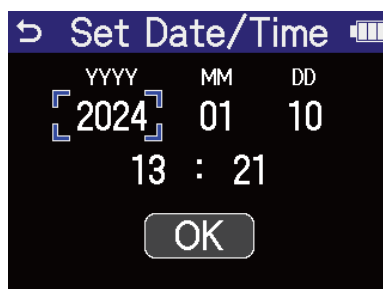

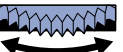
4. Use  to select the item to set and press .



5. Use  to change the value, and press .

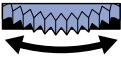

6. Repeat steps 4-5 to set the date and time.

7. After setting all the items, use  to select **OK** and press .

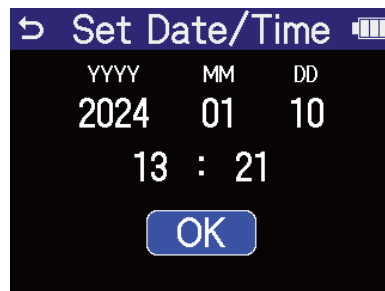



HINT

The first time you turn the power on after purchase or restoring default settings, this screen opens automatically after setting the date format.

Setting the date format

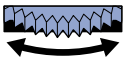
Use this to change the date format used when recording files.

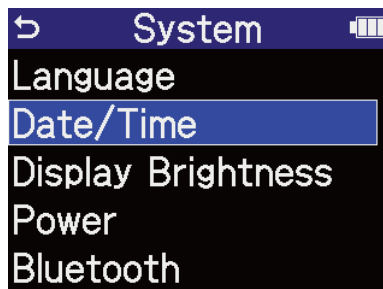

1. On the [Home Screen](#), use  to select  (System) and press . This opens the System Settings Screen.

2. Use  to select "Date/Time" and press .

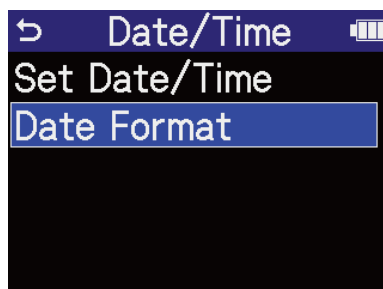

3. Use  to select "Date Format" and press .

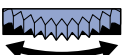

4. Use  to select a date format and press .

A specific example of the set date format will be shown at the bottom right of the screen using the current date setting.

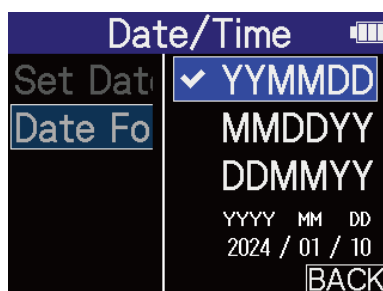



Setting	Explanation
YYMMDD	The date is shown in year, month, day order.
MMDDYY	The date is shown in month, day, year order.
DDMMYY	The date is shown in day, month, year order.



HINT

The first time you turn the power on after purchase or restoring default settings, this screen opens automatically after setting the language shown.

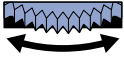
Setting display power saving

In order to conserve energy, the display backlight can be set to dim if no operation is conducted for a specific amount of time.

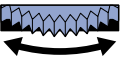

1. On the [Home Screen](#), use  to select  (System) and press . This opens the System Settings Screen.

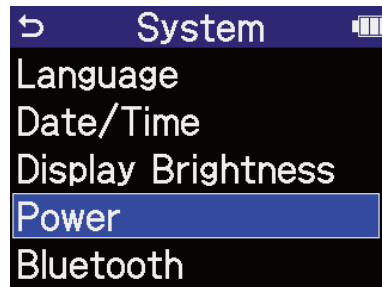
2. Use  to select "Power" and press .

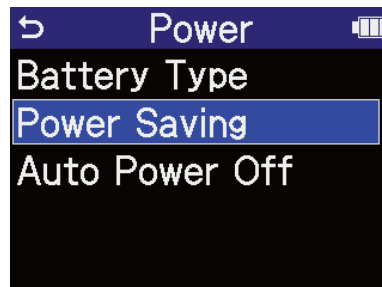

3. Use  to select "Power Saving" and press .

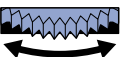

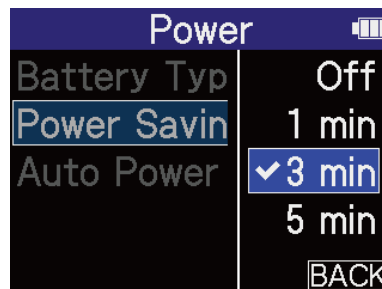

4. Use  to select the setting and press .



Setting	Explanation
Off	The display backlight always stays bright.
1 min, 3 min, 5 min	The display backlight will dim after the set time has elapsed without any operation.

Setting the display brightness

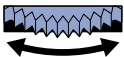
The brightness of the display can be adjusted if it is difficult to see because it is too dim or too intense.

1. On the [Home Screen](#), use  to select  (System) and press . This opens the System Settings Screen.

2. Use  to select "Display Brightness" and press .

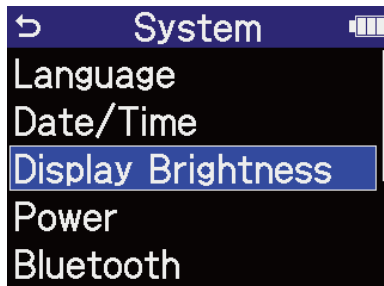

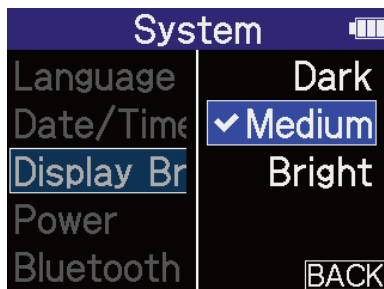

3. Use  to set the display brightness and press .





Setting	Explanation
Dark	The display backlight will always be dark.
Medium	The display brightness will be normal.
Bright	The display will be even brighter.

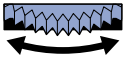

Setting the type of batteries used

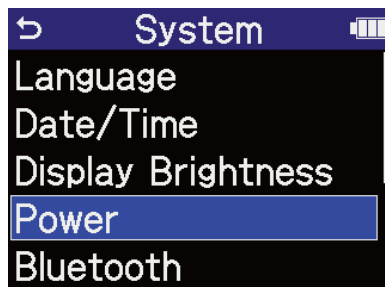
Set the type of batteries used by the H6essential so that the amount of remaining battery charge can be accurately displayed.

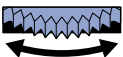

1. On the [Home Screen](#), use  to select  (System) and press . This opens the System Settings Screen.

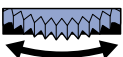

2. Use  to select "Power" and press .

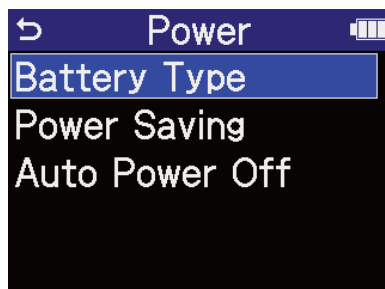
3. Use  to select the "Battery Type" and press .

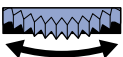

4. Use  to select the battery type and press .

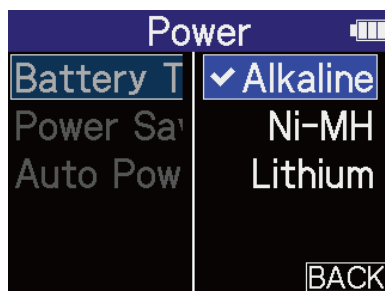

Setting	Explanation
Alkaline	Alkaline batteries
Ni-MH	Nickel-metal hydride batteries
Lithium	Lithium batteries



HINT



The first time you turn the power on after purchase or restoring default settings, the battery type setting appears automatically after setting the date and time.

Setting the time until the power turns off automatically

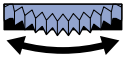

The H6essential can be set so that its power will automatically turn off if it is not used for a set amount of time.

To keep the power on at all times, turn off the automatic power saving setting.

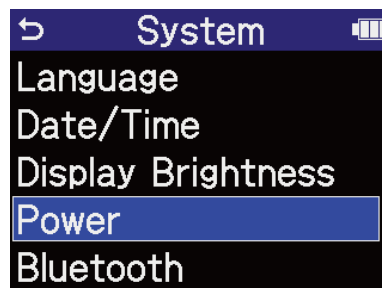

1. On the [Home Screen](#), use  to select  (System) and press  .
This opens the System Settings Screen.

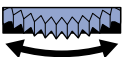
2. Use  to select "Power" and press  .

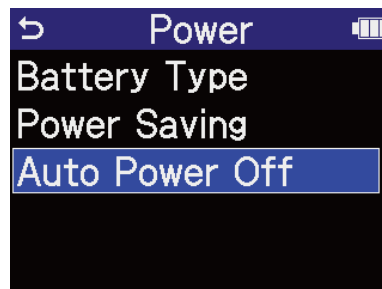

3. Use  to select "Auto Power Off" and press  .

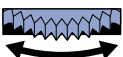

4. Use  to select the time until the power turns off and press  .

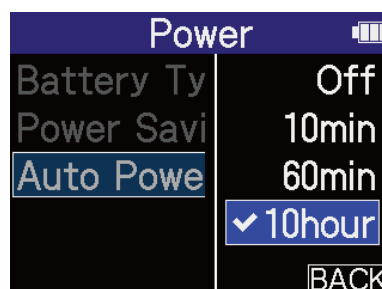

Setting	Explanation
Off	The power will not turn off automatically.
10min, 60min, 10hour	The power will automatically turn off if no operation occurs for the set time.

NOTE



The power will not turn off automatically under the following conditions regardless of the Auto Power Off setting.



- During recording or playback
- When the H6essential is in use as an audio interface
- When the H6essential file transfer function is in use
- During card tests
- During execution of firmware updates

Using the guide sound accessibility feature

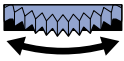

Setting the guide sound (accessibility)

With this function, the names of selected setting items can be read aloud and a beeping sound can be used to notify the occurrence of error messages, recording starting/stopping and volume adjustment, for example.

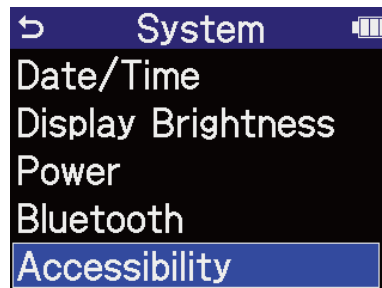

1. On the [Home Screen](#), use  to select  (System) and press . This opens the System Settings Screen.

2. Use  to select "Accessibility" and press .

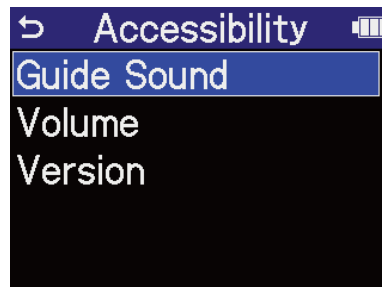

3. Use  to select "Guide Sound" and press .

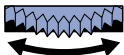

4. Use  to select the setting and press .

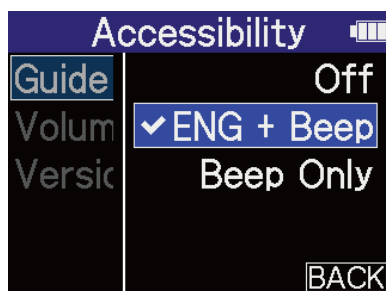

Setting	Explanation
Off	This turns off the guide sound.
XXX + Beep (“XXX” shows the installed language.)	Setting items will be read aloud in the installed language. A beeping sound will be used to notify the occurrence of error messages, recording starting/stopping and volume adjustment, for example. English is installed at the time of purchase, but other languages can be installed and used for reading as desired. (→ Installing guide sounds)
Beep Only	A beeping sound will be used to notify the occurrence of error messages, recording starting/stopping and volume adjustment, for example. Nothing will be read aloud.

NOTE



- The volume of the reading voice and beep sounds can also be adjusted. (→ [Setting the guide sound volume](#))
- The language and version used for the guide sound can be checked on the Version Screen. (→ [Checking guide sound information](#))



HINT

The first time you turn the power on after purchase, this screen opens automatically.

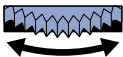

Setting the guide sound volume

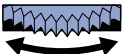
The volume of the reading voice and beep sounds can be adjusted.

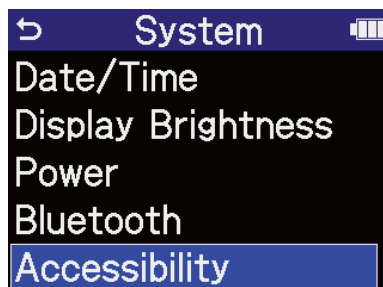

1. On the [Home Screen](#), use  to select  (System) and press . This opens the System Settings Screen.

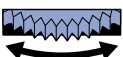
2. Use  to select "Accessibility" and press .

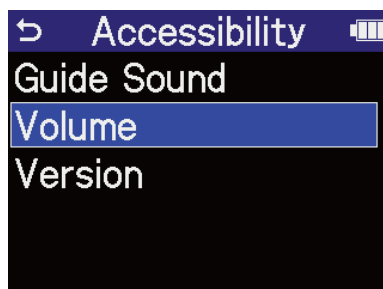

3. Use  to select "Volume" and press .

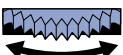

4. Use  to select the volume and press .

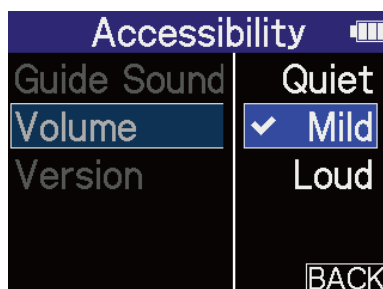

The volume can be set to Quiet, Mild or Loud.

NOTE

The volume determined here is also affected before output by adjustments made using .



  VOLUME



Consider volume adjustments using  when making this setting.

  VOLUME

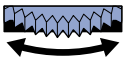

Checking guide sound information

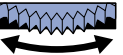
The language and version used for the accessibility guide sounds can be checked.

1. On the [Home Screen](#), use  to select  (System) and press  .
This opens the System Settings Screen.

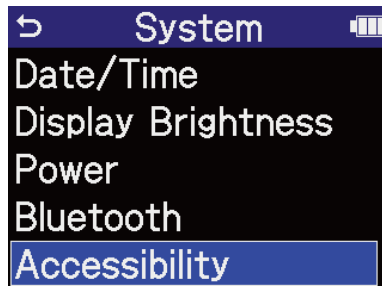
2. Use  to select "Accessibility" and press  .

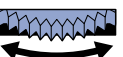

3. Use  to select "Version" and press  .

This opens the Version Screen where the language and version used for the accessibility guide sounds can be checked.

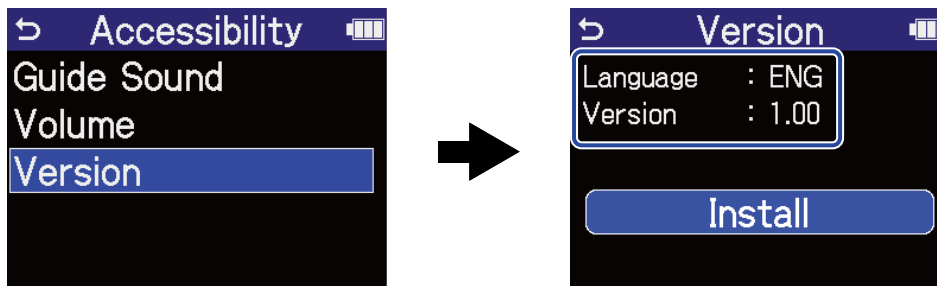

Installing guide sounds



The guide sound is English at the time of purchase.



Guide sound installation can be used to change the language and update the feature.

Download the most recent accessibility installation file necessary to install the guide sound from the ZOOM website (zoomcorp.com). Follow the instructions in the “H6essential Accessibility Installation Guide” on the H6essential download page.



Restoring the factory default state

The H6essential can be restored to its factory default state.

1. On the [Home Screen](#), use  to select  (System) and press . This opens the System Settings Screen.

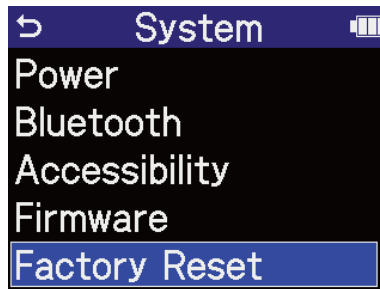
2. Use  to select "Factory Reset" and press .



3. Use  to select "Execute" and press .

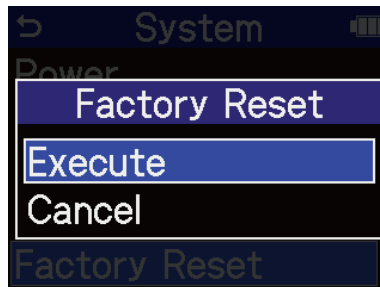

This will restore the H6essential to its factory default state and turn the power off.



NOTE

Initializing settings will overwrite all settings with their factory defaults. Be certain before using this function.

Managing the firmware

Checking the firmware versions

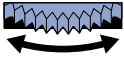
The firmware versions used by the H6essential can be checked.

1. On the [Home Screen](#), use  to select  (System) and press . This opens the System Settings Screen.

2. Use  to select "Firmware" and press .

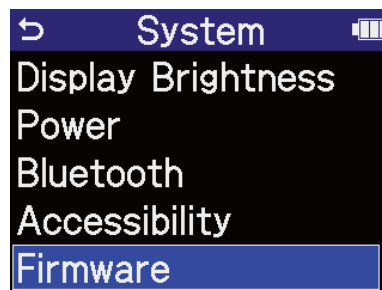

This shows the firmware versions.



Updating the firmware

The H6essential firmware can be updated to the latest versions.

Files for the latest firmware updates can be downloaded from the ZOOM website (zoomcorp.com).

Follow the instructions in the “H6essential Firmware Update Guide” on the H6essential download page.

Operating the H6essential from a smartphone/tablet

The H6essential can be operated wirelessly from a smartphone or tablet by connecting a BTA-1 or other dedicated wireless adapter and using the dedicated H6essential Control app.

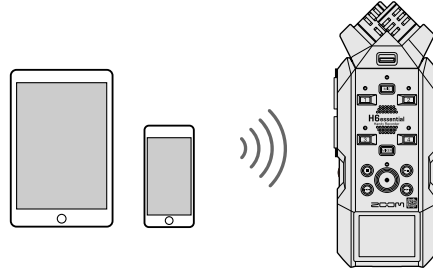

NOTE

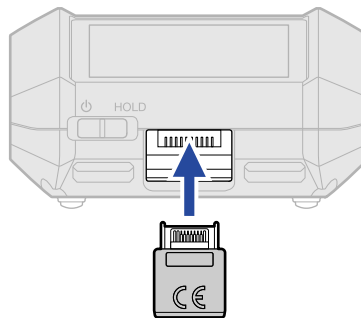

- The H6essential Control app must be installed on the smartphone or tablet beforehand. The H6essential Control app can be downloaded from the App Store. Refer to the manual for the H6essential Control app for details about app settings and operation procedures.
- The H6essential cannot be controlled wirelessly from a smartphone or tablet during audio interface operation (→ [Using as an audio interface](#)).
- An H6essential cannot have both H6essential Control and an UltraSync BLUE connected at the same time.

1. With the H6essential power off, remove the REMOTE connector cover on its front. Then, connect a BTA-1 or other dedicated wireless adapter.

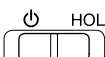

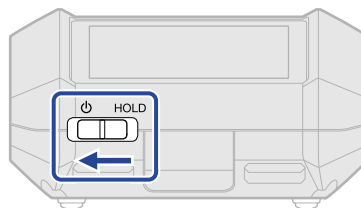

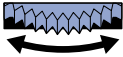
2. Slide  toward  until the display becomes active and the power turns on.

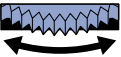

3. On the Home Screen, use  to select the System icon and press . This opens the System Settings Screen.

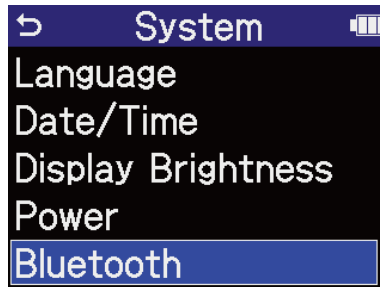
4. Use  to select "Bluetooth" and press .

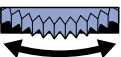

5. Use  to select "H6essential Control" and press .

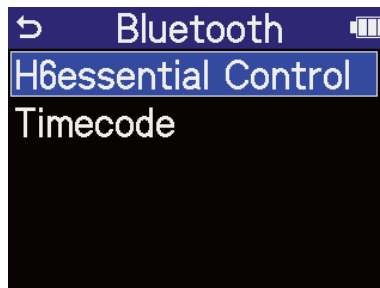

Searching for the device to connect will begin and "Searching" will appear on the display.

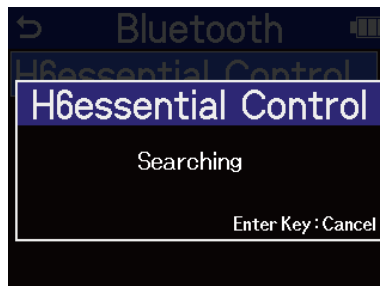

HINT

Searching can be canceled by pressing .

6. Launch the H6essential Control app on the smartphone or tablet. Then, conduct connection procedures from the app.

When connection completes "H6essential Control Connected!" will appear on the display.



Refer to the manual for the H6essential Control app for details about app settings and operation procedures.



Disconnecting from smartphones and tablets

Disconnection is possible by quitting the app on the smartphone or tablet.

Removing the BTA-1 from the H6essential will also disconnect it from H6essential Control.

Checking the latest information for the H6essential

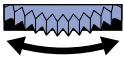
A 2D code for help related to the product can be shown on the H6essential Display.

1. On the [Home Screen](#), use  to select  (System) and press . This opens the System Settings Screen.

2. Use  to select "Help" and press .

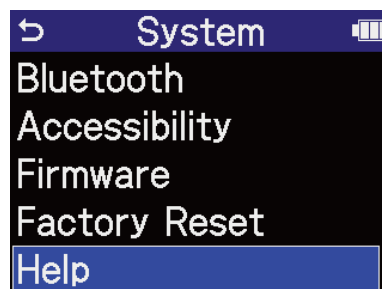

3. Use a smartphone or tablet, for example, to scan the 2D code shown on the Help Screen.



zoomcorp.com/help/h6essential

Appendix

Troubleshooting

If you think that the H6essential is operating strangely, check the following items first.

Recording/playback trouble

There is no sound or output is very quiet

- Check the orientation of the mic or the volume settings of the connected equipment.
- Confirm that the headphone volume and line output level are not too low. (→ [Monitoring input sounds](#), [Adjusting the line output level](#))
- Check the H6essential input source settings. (→ [Enabling tracks for recording](#), [Converting mic capsule input to mono](#), [Enabling stereo linking](#))
- Check the phantom power settings. (→ [Setting phantom power](#))
- Check the volume on the [Mixer Screen](#). (→ [Adjusting the monitoring balance of input sounds](#), [Adjusting the volume balance of all tracks](#))

Monitored sound is distorted

- Use  to adjust the volume.
 VOLUME

Recording is not possible

- Confirm that the microSD card has open space. The available recording time can be checked on screen when recording is paused. (→ [Home Screen](#))
- Confirm that a microSD card is loaded properly in the card slot. (→ [Inserting microSD cards](#))
- Confirm that the input source setting is not "Off". (→ [Enabling tracks for recording](#))
- Check the volume on the [Mixer Screen](#). (→ [Adjusting the monitoring balance of input sounds](#))

Recorded sound cannot be heard or is very quiet

- Confirm that the input source setting is correct for the connected device. (→ [Setting phantom power](#), [Enabling stereo linking](#))

“MIC INPUT OVERLOAD!” or “INPUT 1 (2/3/4) OVERLOAD!” appears

- The input sound is too loud. Increase the distance between the mic and the sound source.
- Wind can also cause loud noises to be input. We recommend using the Lo Cut setting to reduce noise if air is blown directly at a mic, for example, when recording outdoors or when a mic is near the mouth of a speaker. (→ [Reducing noise \(Lo Cut\)](#))

Other trouble

The recorder is not recognized by a computer, smartphone or tablet even though it is connected through the USB port

- Use a USB cable that supports data transfer.
- The operation mode must be set on the H6essential to allow the computer, smartphone or tablet to recognize it. (→ [Using as an audio interface](#), [Transferring files to computers and other devices](#))
- Confirm that the computer, smartphone or tablet and the application being used are compatible with 32-bit float format.
- Even if “H6essential” cannot be selected for the “Sound” setting on a computer, by selecting “H6essential” as the “Audio” or “Input/Output” device in an application that supports 32-bit float format, it can be used as a 32-bit float audio interface.
- A driver is necessary to use 32-bit float format with Windows. The driver can be downloaded from the ZOOM website (zoomcorp.com).

Battery operation time is short

Making the following settings could increase the battery operation time.

- Set the type of batteries used correctly. (→ [Setting the type of batteries used](#))
- Turn off inputs that are not used. (→ [Enabling tracks for recording](#))
- Set the display to dim when not operated for a specific amount of time. (→ [Setting display power saving](#))
- Reduce the display brightness. (→ [Setting the display brightness](#))
- Reduce the sample rate used to record files. (→ [Setting the sample rate](#))
- Disconnect unnecessary cables from the headphone and LINE OUT jacks.
- Due to their characteristics, using nickel metal hydride batteries (especially high-capacity ones) or lithium batteries should enable longer use than alkaline batteries when power consumption is high.

An accessibility update is recommended

- Use the latest accessibility installation file to update. (→ [Installing guide sounds](#))

H6essential metadata list

Metadata contained in BEXT chunks in WAV files

Tag	Explanation	Remarks
zSPEED=	Frame rate	
zTAKE=	Take number	
zUBITS=	User bits	
zSCENE=	Scene name	System > Date/Time
zTAPE=		
zCIRCLED=		
zTRKn=	Track name	
zNOTE=		

Metadata contained in iXML chunks in WAV files

○ = YES × = NO

iXML master tag	iXML sub tag	Written	Read	Remarks
<PROJECT>		○	×	
<SCENE>		○	○	System > Date/Time
<TAKE>		○	×	
<TAPE>		○	×	
<CIRCLED>		○	×	
<WILD TRACK>		×	×	
<FALSE START>		×	×	
<NO GOOD>		×	×	
<FILE UID>		○	×	
<UBITS>		○	×	
<NOTE>		○	×	
<BEXT>		×	×	
<USER>		×	×	

iXML master tag	iXML sub tag	Written	Read	Remarks
<SPEED>				
<SPEED>	<NOTE>	○	×	
<SPEED>	<MASTER_SPEED>	○	×	
<SPEED>	<CURRENT_SPEED>	○	×	
<SPEED>	<TIMECODE_RATE>	○	×	
<SPEED>	<TIMECODE_FLAG>	○	×	
<SPEED>	<FILE_SAMPLE_RATE>	○	○	Rec Settings > Sample Rate
<SPEED>	<AUDIO_BIT_DEPTH>	○	×	
<SPEED>	<DIGITIZER_SAMPLE_RATE>	○	×	Rec Settings > Sample Rate
<SPEED>	<TIMESTAMP_SAMPLES_SINCE_MIDNIGHT_HI>	○	×	
<SPEED>	<TIMESTAMP_SAMPLES_SINCE_MIDNIGHT_LO>	○	×	
<SPEED>	<TIMESTAMP_SAMPLE_RATE>	○	×	Rec Settings > Sample Rate

iXML master tag	iXML sub tag	Written	Read	Remarks
<SYNC_POINT_LIST>				
<SYNC_POINT>	<SYNC_POINT_TYPE>	x	x	
<SYNC_POINT>	<SYNC_POINT_FUNCTION>	x	x	
<SYNC_POINT>	<SYNC_POINT_COMMENT>	x	x	
<SYNC_POINT>	<SYNC_POINT_LOW>	x	x	
<SYNC_POINT>	<SYNC_POINT_HIGH>	x	x	
<SYNC_POINT>	<SYNC_POINT_EVENT_DURATION>	x	x	

iXML master tag	iXML sub tag	Written	Read	Remarks
<HISTORY>				
<HISTORY>	<ORIGINAL_FILENAME>	○	x	
<HISTORY>	<PARENT_FILENAME>	x	x	
<HISTORY>	<PARENT_UID>	x	x	

iXML master tag	iXML sub tag	Written	Read	Remarks
<FILE_SET>				
<FILE_SET>	<TOTAL_FILES>	○	x	
<FILE_SET>	<FAMILY_UID>	○	x	
<FILE_SET>	<FAMILY_NAME>	x	x	
<FILE_SET>	<FILE_SET_START_TIME_HI>	x	x	
<FILE_SET>	<FILE_SET_START_TIME_LO>	x	x	
<FILE_SET>	<FILE_SET_INDEX>	○	x	

iXML master tag	iXML sub tag	Written	Read	Remarks
<TRACK_LIST>				
<TRACK_LIST>	<TRACK_COUNT>	○	×	
<TRACK>	<CHANNEL_INDEX>	○	×	
<TRACK>	<INTERLEAVE_INDEX>	○	×	
<TRACK>	<NAME>	○	×	
<TRACK>	<FUNCTION>	×	×	

Specifications

Input and output channels	Inputs	Mic capsule	1		
		MIC/LINE (mono)	4		
	Outputs	LINE OUT	1		
		Headphone	1		
Built-in speaker (mono)		1			
Inputs	XY mic: XYH-6e	90° XY stereo format			
		Directionality	Unidirectional		
		Sensitivity	-42dB/1Pa at 1kHz		
		Maximum sound pressure input	135 dB SPL		
	MIC/LINE (mono)	Connectors	4 XLR/TRS combo jacks (XLR: 2 HOT, TRS: TIP HOT)		
		Input gain	Adjustment unnecessary (dual A/D converter circuits used)		
		Input impedance	MIC: 3.8 k Ω or more LINE: 39 k Ω or more		
		Maximum input level	MIC: +4 dBu LINE: +24 dBu		
		Phantom power	+48 V Channel total 32 mA or less		
		Equivalent input noise	MIC: -120 dBu or less (IHF-A) at 150 Ω input LINE: -95 dBu or less (IHF-A) at 600 Ω input		
		Outputs	LINE OUT	Connector	1 stereo mini jack
				Maximum output level	+1 dBu
				Output impedance	110 Ω or less
Headphone	Connector	1 stereo mini jack			
	Maximum output level	20 mW + 20 mW (when 32 Ω load)			
	Output impedance	10 Ω or less			
Built-in speaker	Type	20 mm \times 30 mm elliptical dynamic speaker			
	Effective maximum output	250 mW			
Recorder		Maximum simultaneous recording tracks	8		

	Maximum simultaneous playback tracks	6
	Recording format	WAV 44.1/48/96 kHz, 32-bit float mono/stereo BWF and iXML formats supported
	Recording media	4–32GB cards compatible with the microSDHC specification 64GB–1TB cards compatible with the microSDXC specification
Display		2.00" full-color LCD (320 × 240)
USB	Connector	USB Type-C • Use a USB cable that supports data transfer. USB bus power is supported.
	Audio interface	USB 2.0 High Speed
	Input and output channels	6 in / 2 out (Multi) 2 in / 2 out (Stereo)
	Sampling frequency	44.1/48/96 kHz (AIF only) 44.1/48 kHz (AIF + onboard recording)
	Bit depth	24-bit, 32-bit float
	File transfer	USB 2.0 High Speed
REMOTE		Dedicated wireless adapter (ZOOM BTA-1)
Power		4 AA batteries (alkaline, lithium or rechargeable NiMH batteries) AC adapter (ZOOM AD-17): DC 5V/1A • USB bus power is supported.
Estimated continuous operation times using batteries • These values are approximate. • Continuous battery operation times were determined using in-house testing methods. They will vary greatly according to use conditions.	2-track (XYH-6e) recording at 48 kHz/32-bit float with phantom power off, no headphones, no LINE OUT, no REMOTE, Power Saving on, Display Brightness Medium	Alkaline batteries: about 18 hours NiMH batteries (1900 mAh): about 14.5 hours Lithium batteries: about 30 hours
	6-track (XYH-6e and inputs 1–4) recording at 48 kHz/32-bit float with phantom power off, headphones used (33Ω load), no LINE OUT, no REMOTE, Power Saving on, Display Brightness Medium	Alkaline batteries: about 3.5 hours NiMH batteries (1900 mAh): about 4 hours Lithium batteries: about 9 hours
Power consumption		5 W maximum

Dimensions	Recorder: 78.1 mm (W) × 160.1 mm (D) × 42.8 mm (H) XYH-6e: 69.1 mm (W) × 50.8 mm (D) × 43.0 mm (H)
Weight	381 g (including batteries) XYH-6e: 42 g

Note: 0 dBu = 0.775 Vrms



ZOOM CORPORATION

4-4-3 Kanda-surugadai, Chiyoda-ku, Tokyo 101-0062 Japan

zoomcorp.com