

# GUITAR EFFECTS CONSOLE

# G7.1ut

## Operation Manual

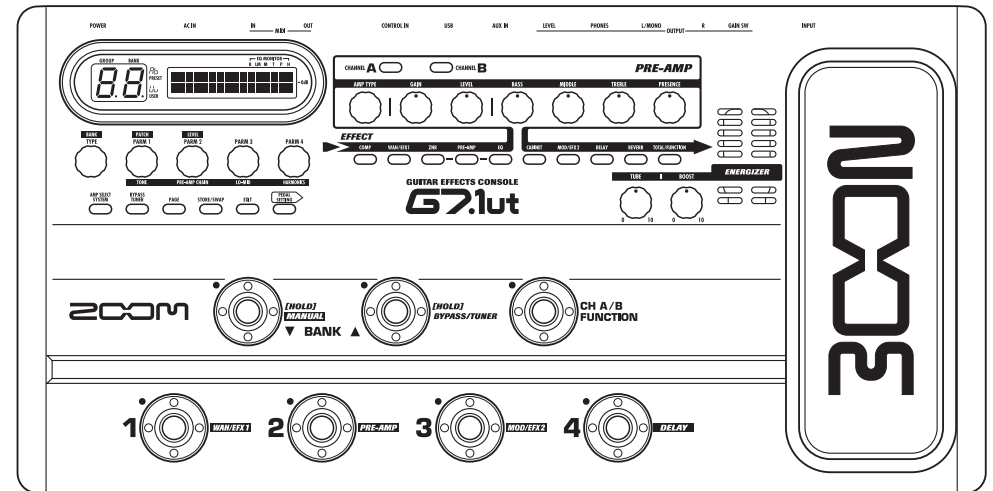

# ZOOM

© ZOOM Corporation  
Reproduction of this manual, in whole or in part,  
by any means, is prohibited.

# SAFETY PRECAUTIONS Usage Precautions

## SAFETY PRECAUTIONS

In this manual, symbols are used to highlight warnings and cautions for you to read so that accidents can be prevented. The meanings of these symbols are as follows:



This symbol indicates explanations about extremely dangerous matters. If users ignore this symbol and handle the device the wrong way, serious injury or death could result.



This symbol indicates explanations about dangerous matters. If users ignore this symbol and handle the device the wrong way, bodily injury and damage to the equipment could result.

Please observe the following safety tips and precautions to ensure hazard-free use of the G7.1ut.



### Power requirements

- Be sure to use only an AC adapter which supplies 15 V DC, 1.5A (Zoom AD-0012). The use of an adapter other than the specified type may damage the unit and pose a safety hazard.
- Connect the AC adapter only to an AC outlet that supplies the rated voltage required by the adapter.
- When disconnecting the AC adapter from the AC outlet, always grasp the adapter itself and do not pull at the cable.
- During lightning or when not using the unit for an extended period, disconnect the AC adapter from the AC outlet.
- Do not pinch the power cord, bend it forcedly, or place heavy objects on the power cord.



### Environment

To prevent the risk of fire, electric shock or malfunction, avoid using your G7.1ut in environments where it will be exposed to:

- Extreme temperatures
- Heat sources such as radiators or stoves
- High humidity or moisture
- Excessive dust or sand
- Excessive vibration or shock

Keep a minimum distance of 5 cm around the unit for sufficient ventilation.

Do not impede the ventilation openings with objects such as newspapers or curtains.



### Handling

- Never place objects filled with liquids, such as vases, on the G7.1ut since this can cause electric shock.
- Do not place naked flame sources, such as lighted candles, on the G7.1ut since this can cause fire.



- The G7.1ut is a precision instrument. Do not exert undue pressure on the keys and other controls. Also take care not to drop the unit, and do not subject it to shock or excessive pressure.

- Take care that no foreign objects (coins or pins etc.) or liquids can enter the unit.



### Connecting cables and input and output jacks

You should always turn off the power to the G7.1ut and all other equipment before connecting or disconnecting any cables. Also make sure to disconnect all connection cables and the power cord before moving the G7.1ut.



### Alterations

Never open the case of the G7.1ut or attempt to modify the product in any way since this can result in damage to the unit.



### Volume

Do not use the G7.1ut at a loud volume for a long time since this can cause hearing impairment.

## Usage Precautions

### Electrical interference

For safety considerations, the G7.1ut has been designed to provide maximum protection against the emission of electromagnetic radiation from inside the device, and protection from external interference. However, equipment that is very susceptible to interference or that emits powerful electromagnetic waves should not be placed near the G7.1ut, as the possibility of interference cannot be ruled out entirely.

With any type of digital control device, the G7.1ut included, electromagnetic interference can cause malfunctioning and can corrupt or destroy data. Care should be taken to minimize the risk of damage.

### Cleaning

Use a soft, dry cloth to clean the G7.1ut. If necessary, slightly moisten the cloth. Do not use abrasive cleanser, wax, or solvents (such as paint thinner or cleaning alcohol), since these may dull the finish or damage the surface.

**Please keep this manual in a convenient place for future reference.**

\* MIDI is a registered trademark of Association of Musical Electronics Industry(AMEI).

# Contents

<b>SAFETY PRECAUTIONS Usage Precautions</b> .....	2
<b>Features</b> .....	4
<b>Terms Used in This Manual</b> .....	5
<b>Controls and Functions</b> .....	6
<b>Getting Connected</b> .....	8
<b>Power-On</b> .....	9
<b>Quick Guide 1 (Play Mode/Manual Mode Operation)</b> .....	10
<b>Quick Guide 2 (Edit Mode/Store Mode Operation)</b> .....	12
<b>Selecting Patches for Playing (Play Mode)</b> .....	14
Panel display .....	14
Selecting a patch .....	14
Adjusting the sound .....	15
Using the Energizer .....	16
<b>Switching Modules On and Off With Your Foot During Play (Manual Mode)</b> .....	18
<b>Using the Internal Tuner (Bypass/Mute Condition)</b> .....	20
Using the chromatic tuner .....	20
Using other tuner types .....	22
<b>Changing the Sound of a Patch (Edit Mode)</b> .....	23
Patch configuration.....	23
Basic edit mode steps .....	23
Changing a patch name .....	26
<b>Storing Patches and Banks (Store Mode)</b> .....	27
Storing/swapping patches .....	27
Storing/swapping banks .....	28
Returning patches to factory default condition .....	29
<b>Using the Expression Pedal</b> .....	30
About the built-in expression pedal .....	30
Assigning control targets to the built-in expression pedal .....	30
Adjusting the built-in expression pedal.....	32
Using an external expression pedal.....	33
<b>Using the Function Foot Switch</b> .....	34
Specifying the tempo for a patch .....	35
<b>MIDI Usage Examples</b> .....	37
What you can do with MIDI.....	37
Selecting the MIDI channel .....	37
Sending and receiving patch switching information via MIDI (program change).....	38
Sending and receiving pedal/switch/key operation information via MIDI (control change) .....	41
Sending and receiving G7.1ut internal data via MIDI .....	44
<b>Other Functions</b> .....	46
Using the ARRМ function.....	46
Using the G7.1ut as audio interface for a computer.....	48
Muting the direct output when using a USB connection .....	49
About the editor/librarian software....	50
Adjusting the display contrast .....	50
<b>Linking Effects</b> .....	51
Switching between live performance sound and direct recording sound ...	51
Using the Amp Select Function .....	52
Changing the insert position of the pre-amp section and WAH/EFX1 module .....	52
<b>Effect Types and Parameters</b> .....	54
How to read the parameter table.....	54
COMP module .....	55
WAH/EFX1 module.....	55
ZNR module.....	57
PRE AMP module .....	58
EQ module.....	59
CABINET module.....	60
MOD/EFX2 module.....	60
DELAY module.....	64
REVERB module.....	65
TOTAL module.....	66
<b>Troubleshooting</b> .....	68
<b>Specifications</b> .....	69
MIDI implementation chart.....	70

\* Microsoft and Windows XP are registered trademarks of Microsoft Corporation.

\* Macintosh is a registered trademark of Apple Computer.

\* All other trademarks, product names, and company names mentioned in this document are the property of their respective owners.

\* Manufacturer names and product names mentioned in this document are trademarks or registered trademarks of their respective owners. The names are used only to illustrate sonic characteristics and do not indicate any affiliation with ZOOM CORPORATION.

# Features

Thank you for selecting the **ZOOM G7.1ut** (simply called the "**G7.1ut**" in this manual). The G7.1ut is a sophisticated Multi Effect Processor with the following features.

## ● Latest technology for top performance

Excellent sound quality is assured by signal processing featuring 96 kHz/24 bit sampling and internal 32-bit processing. Frequency response remains flat to 40 kHz, and input converted noise is an amazing -120 dB or better. The built-in USB port serves for direct connection to a computer. You can use the G7.1ut as audio interface for the computer, allowing direct recording with the supplied DAW software.

## ● Versatile array of 92 effects

Out of a versatile palette of 92 effects, up to nine (including ZNR) can be used simultaneously. Recreate the sound of famous amps and compact effects, use the 6-band guitar equalizer, or select from many other great effects. The G7.1ut easily surpasses the usual feature complement in this class.

## ● Ready-to-go patches

Effect module combinations and settings can be stored and recalled as patches. The G7.1ut offers 80 preset patches that are ready to use right out of the box, plus 80 user patches which can be freely rewritten, giving you a total of 160 choices. The muting interval when switching patches has been reduced to less than 7 milliseconds, which makes for virtually seamless patch changes.

## ● Great for stage work or direct recording

The pre-amp section features two channels, and each distortion type has two dedicated algorithms, one for live playing and one for direct recording. The CABINET effect simulates amp and mic recording characteristics, and the algorithm is automatically switched according to the CABINET on/off setting. An amp select feature matches the sound to the amp you are using. Connecting the G7.1ut to the power amplifier input of the guitar amp is no problem: simply set the -10 dBm/+4 dBm switch to the +4 dBm position.

## ● Built-in auto-chromatic tuner supports special tuning requirements

In addition to the standard auto-chromatic tuner, various other tuning methods are possible. The tuner is designed to allow easy use on stage.

## ● Expression pedal supplied as standard

Adjust effect tone or volume in real time with the expression pedal that is built right into the unit. The possibilities for creative play are endless. The CONTROL IN jack on the rear panel lets you connect an external pedal (FP01/FP02) and use it as a dedicated volume pedal.

## ● Tube powered energizer

The tube-based Energizer shapes the analog output signal to produce that characteristic warm and dynamic sound that is the hallmark of a tube amplifier.

## ● Programmable function switch

The user-programmable function switch further enhances flexibility and lets you optimize the unit for any application. Use it to switch pre-amp channels, set the delay time, turn hold delay on and off, or for various other tasks.

Please take the time to read this manual carefully, in order to get the most out of your G7.1ut and to ensure optimum performance and reliability.

# Terms Used in This Manual

This section explains some important terms that are used throughout the G7.1ut documentation.

## ■ Effect module

As shown in the illustration below, the G7.1ut can be thought of as a combination of several single effects. Each of these is referred to as an effect module. In addition to modules such as the compressor effect module (COMP), amp simulator/distortion effect module (PRE-AMP), and modulation effect module (MOD/EFX2), the G7.1ut also provides a module for ZNR (ZOOM Noise Reduction). Parameters such as effect intensity can be adjusted for each module individually, and modules can be switched on and off as desired. The module series ZNR, PRE-AMP, EQ, and CABINET operates as a virtual preamplifier which is controlled with the knobs and keys on the pre-amp section of the panel.

## ■ Effect type

Most effect modules comprise several different effects which are referred to as effect types. For example, the modulation effect module (MOD/EFX2) comprises chorus, flanger, pitch shifter, delay, and other effect types. Only one of these can be selected at any time.

## ■ Effect parameter

All effect modules have aspects that can be controlled. These are called effect parameters, adjusted with the parameter knobs 1 – 4 on the panel. When thinking of an effect module as a compact effect, the parameters change the tone and effect intensity similar to the knobs on the device.

## ■ Patch

In the G7.1ut, effect module combinations are stored and called up in units referred to as patches. A patch comprises information about the on/off status of each effect module, about the effect type used in each module, and about effect parameter settings. Expression pedal settings and tempo settings are also stored for each patch individually.

## ■ Bank and group

Patches are organized in preset groups (A, b) which

are read-only, and user groups (U, u) which can be modified. Since each group comprises 40 patches, groups A, b, U, and u offer a total of 160 patches. In the G7.1ut, patches are called up four at a time and selected with the foot switches. These four patches are together referred to as a bank. There are ten banks in a group, numbered 0 through 9.

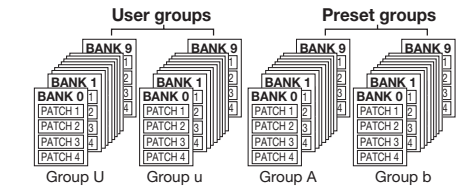

## ■ Modes

The G7.1ut has five different operation modes, as listed below.

### ● Play mode

In this mode, patches can be selected and played. This is the default mode of the G7.1ut that is always active when power is turned on.

### ● Manual mode

In this mode, you play your instrument while using the foot switches to turn modules on and off.

### ● Edit mode

In this mode, the effect parameters of a patch can be edited (changed).

### ● Store mode

This mode serves for storing edited patches. It also allows changing the store positions of patches.

### ● Bypass/mute mode

When the G7.1ut is in the bypass condition, effect processing is temporarily turned off and only the original sound is heard. In the mute mode, all sound is turned off. The built-in tuner can be used in either condition.

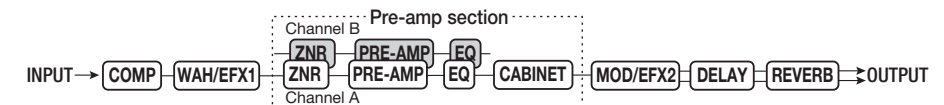

# Controls and Functions

## Top panel

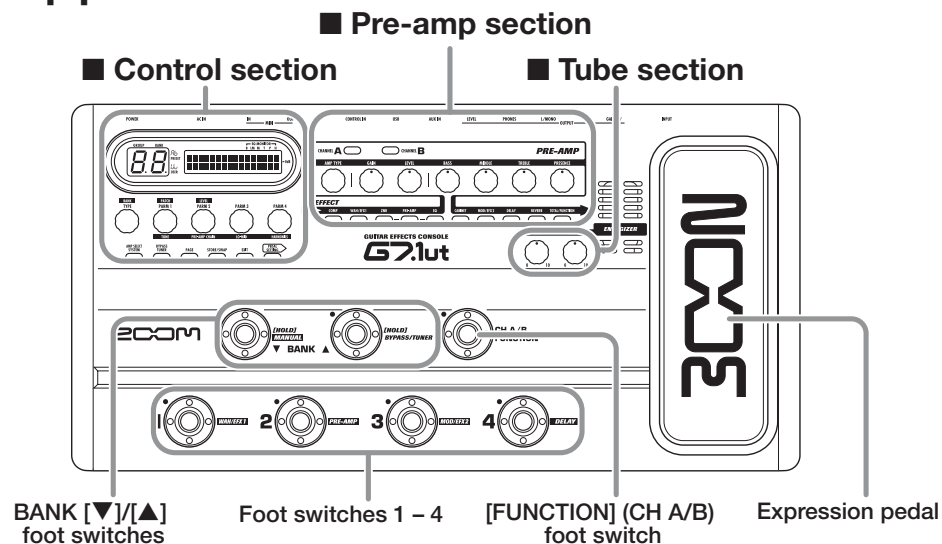

## Rear panel

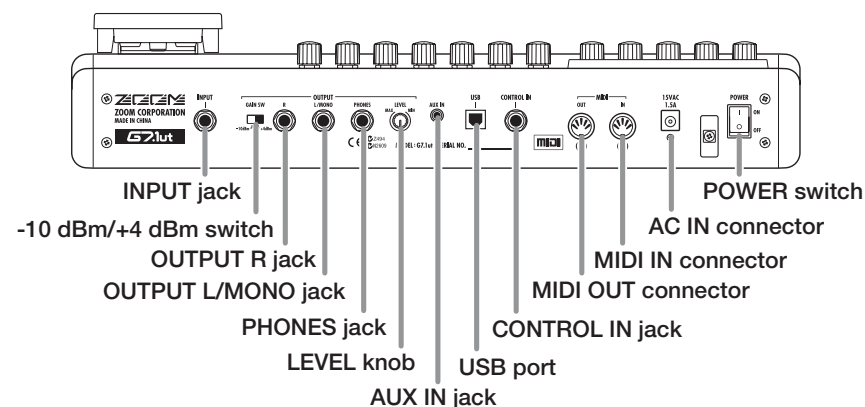

## Control section

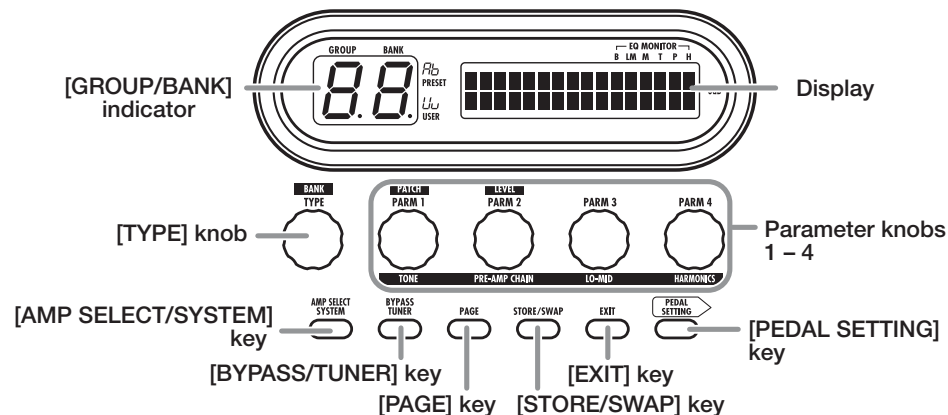

## Pre-amp section

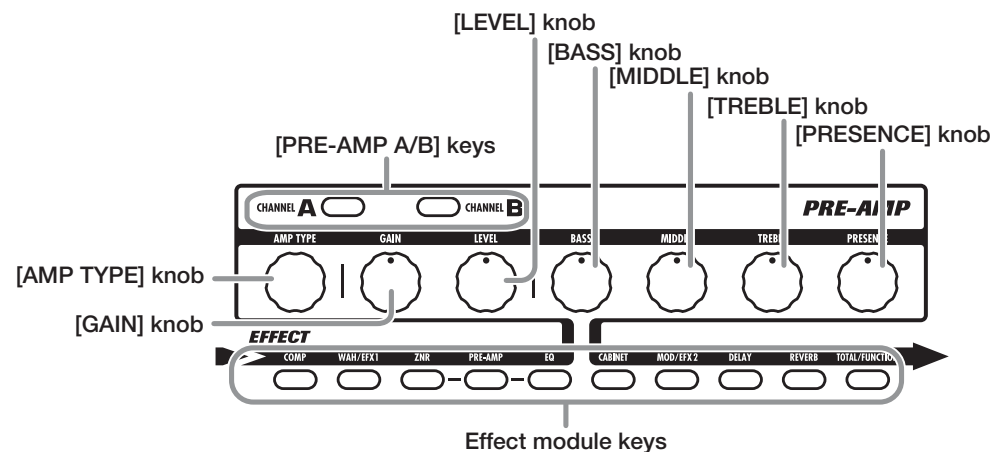

## Tube section

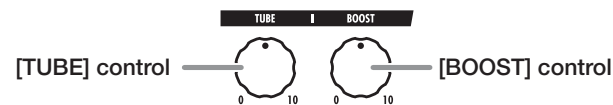

# Getting Connected

Refer to the examples shown below when making connections.

## Connection example (1)

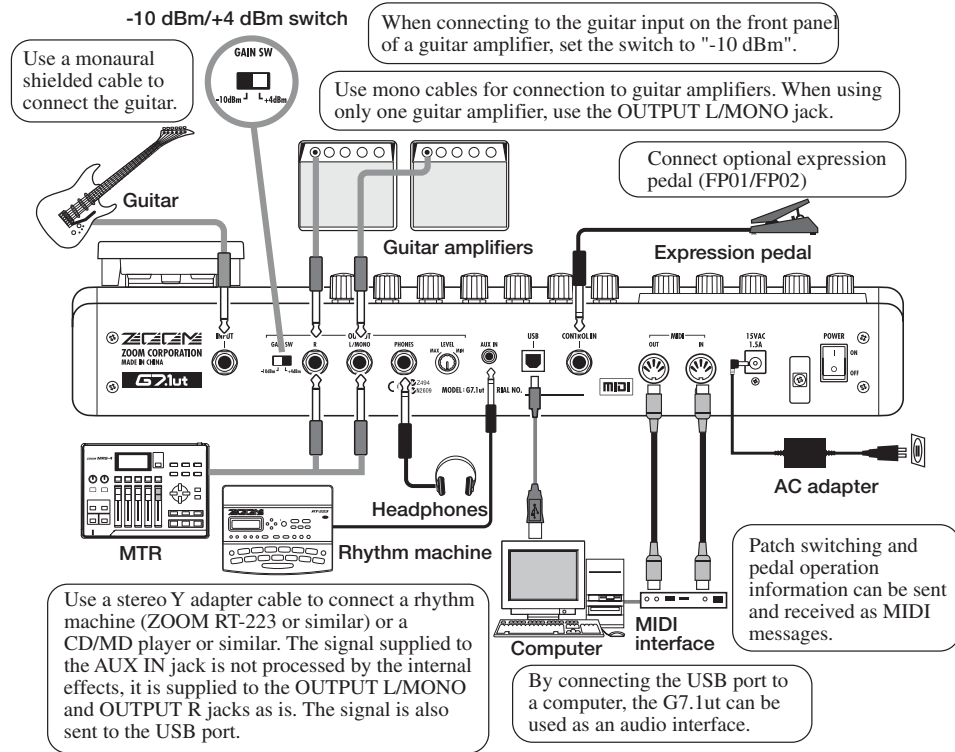

## Connection example (2)

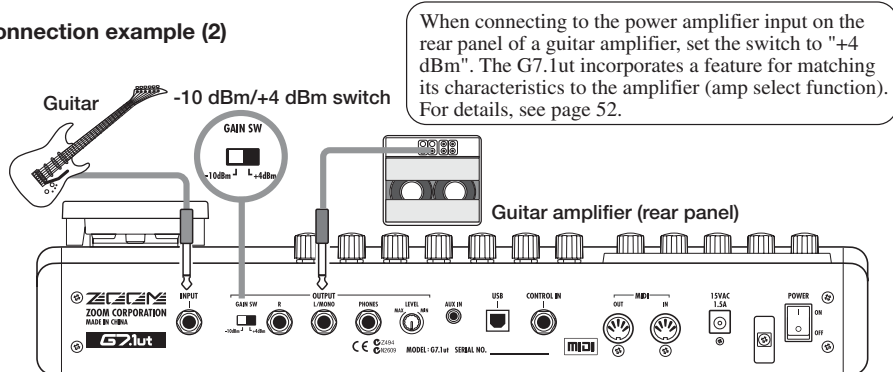

# Power-On

The steps for turning on the G7.1ut are described below.

## 1. Make sure that any connected guitar amplifier is turned off.

In addition, fully turn down the volume control at the guitar amplifier.

## 2. Plug the AC adapter into an AC outlet and plug the cable from the adapter into the AC IN connector of the G7.1ut.

## 3. Use a monaural cable to connect the guitar to the INPUT jack of the G7.1ut.

## 4. Use a monaural cable to connect the OUTPUT L/MONO jack to the guitar amplifier (when using one amplifier) and the OUTPUT R jack to the second guitar amplifier (when using two amplifiers).

## HINT

To monitor with headphones, plug the headphone cable into the PHONES jack of the G7.1ut.

## 5. Turn power on in the following order: G7.1ut → guitar amplifier(s)

## NOTE

Proceed with care when powering up the system. If you turn on power to the G7.1ut while the guitar amplifier is already on, there is a risk of hearing damage and damage to the speakers.

## 6. Play your guitar and adjust the volume control on the guitar amplifier, on the guitar, and the LEVEL knob on the rear panel of the G7.1ut to obtain optimum listening volume.

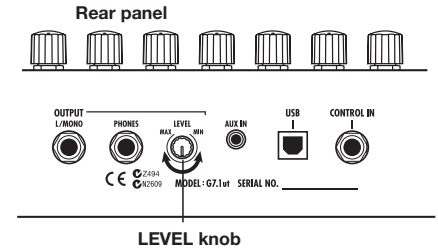

## HINT

The G7.1ut has a so-called "Amp Select" feature that lets you match the unit to various kinds of amplifiers. If necessary, select the appropriate setting for your amplifier the first time you use the G7.1ut (→ p. 52).

## 7. To shut down the system, turn power to the respective components off in the reverse order than during power-up.

## HINT

When the -10 dBm/+4 dBm switch on the rear panel is set to "-10 dBm" and the LEVEL knob is turned fully up, the G7.1ut has unity gain (output level is the same as input level).



# Quick Guide 1 (Play Mode/Manual Mode Operation)

This section explains various basic steps, allowing you to use the G7.1ut right away.

## 1 Selecting a patch (play mode)

Immediately after power-on, the unit will be in play mode, which is for playing your instrument while selecting patches.

- To select a patch, use foot switches 1 – 4.

[Indication in play mode]  
Group name/Bank number



Patch name

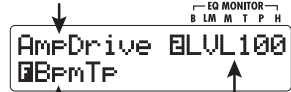

Patch level

Function foot switch assignment

### HINT

- You can switch patches within the same group/bank by turning parameter knob 1.
- You can adjust the patch level (output level of the individual patch) by turning parameter knob 2.

- To select a patch from another group/bank, use the BANK [▼]/[▲] foot switches to select the group/bank and then use foot switches 1 – 4.

**HINT** You can switch the group/bank by turning the [TYPE] knob.

## 2 Turning a module on and off with your foot (manual mode)

In manual mode, you can use foot switches 1 – 4 to switch a module on and off.

- In play mode, keep the BANK [▼] foot switch depressed for more than one second.

The G7.1ut switches to manual mode.

### NOTE

In manual mode, the foot switches do not select patches. However, the [TYPE] knob (group/bank selection) and parameter knob 1 (patch selection) function the same as in play mode. Please note that you go back to "play mode" when you change patches.

## 3 Pre-amp operation

The pre-amp section allows you to adjust distortion type, intensity, and EQ for two channels (A/B) separately.

Distortion type  
[AMP TYPE] knob

[Pre-amp section]

Pre-amp  
module  
output level  
[LEVEL] knob

Mid range  
boost/cut  
[MIDDLE] knob

Ultra-high  
range boost/cut  
[PRESENCE] knob

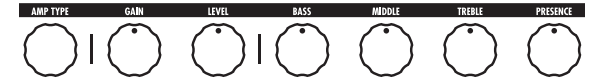

[GAIN] knob  
Distortion  
intensity

[BASS] knob  
Low range  
boost/cut

[TREBLE] knob  
High range  
boost/cut

- Select the channel for which to make a setting with the [PRE-AMP A/B] keys.

The key light shows which channel is currently selected.

**HINT** You can switch between channel A and B with the [FUNCTION] (CH A/B) foot switch (→ p. 34).

- Turn the knobs of the pre-amp section to make adjustments.

The sound of the channel selected in step 1 changes. When you operate a knob, the name of the parameter and the current setting value appear on the display. To return to play mode (or manual mode), press the [EXIT] key.

**NOTE** The changes that you have made to a patch will be lost when you select another patch. To keep the changes, store the patch first (→ p. 13).

- Press the foot switch for the module to be switched on and off.

[Foot switch and corresponding modules]

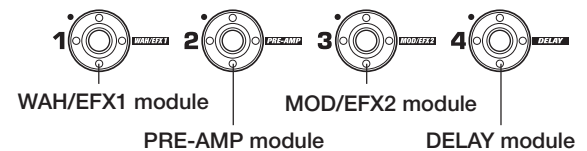

- To return to play mode, press the BANK [▼] foot switch.

# Quick Guide 2 (Edit Mode/Store Mode Operation)

This section explains how to edit a selected patch and how to store the changes you have made.

## 1 Editing a patch (edit mode)

### 1. Press the effect module key for the module to edit.

The unit switches to edit mode. By repeatedly pressing the effect module key, the respective module can be toggled between on and off.

[Display in edit mode]

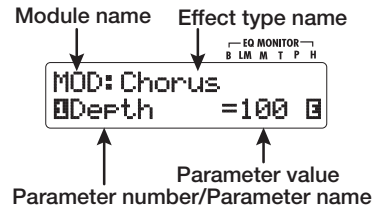

### NOTE

If you press the PRE-AMP/EQ module key, the display will be different. For details, see page 24.

### 2. Use the [TYPE] knob and parameter knobs 1 – 4 to make adjustments.

[TYPE] knob  
Changes the effect type.



Parameter knobs 1 – 4

Change the respective parameter. For information on parameters assigned to the knobs, see page 55 – 67.

### HINT

- The effect type (distortion type) of the PRE-AMP module can be changed with the [AMP TYPE] knob.
- The major parameters of the PRE-AMP/EQ module can be edited with the knobs of the pre-amp section, in the same way as in play mode.

### NOTE

The changes that you have made to a patch will be lost when you select another patch. To keep the changes, store the patch first.

## 2 Storing a patch (store mode)

### 1. In play mode, manual mode, or edit mode, press the [STORE/SWAP] key.

[Display in store mode]



### 2. The indication "PATCH" appears in the top right of the display and the indication "STORE?" in the bottom left. Make sure that the operation is what you intend to do.

In this condition, you can store individual patches. If the display is different, use parameter knob 2 to bring up the "STORE?" indication and parameter knob 3 to bring up the "PATCH" indication.

**HINT** In store mode, you can swap patches as well as store and swap entire banks (→ p. 27 – 28).

### 3. Use the BANK [▼]/[▲] foot switches and foot switches 1 – 4 to select the store target bank and patch number.

- NOTE**
- Only user group patches can be specified as store target.
  - When a patch from a user group is selected, this patch becomes the default store target.
  - When a patch from a preset group is selected, the first user group patch becomes the default store target.

### 4. Press the [STORE/SWAP] key once more.

The store process is carried out, and the unit returns to play mode.

**HINT** You can return the user group patches easily to the factory default settings (→ p. 29).

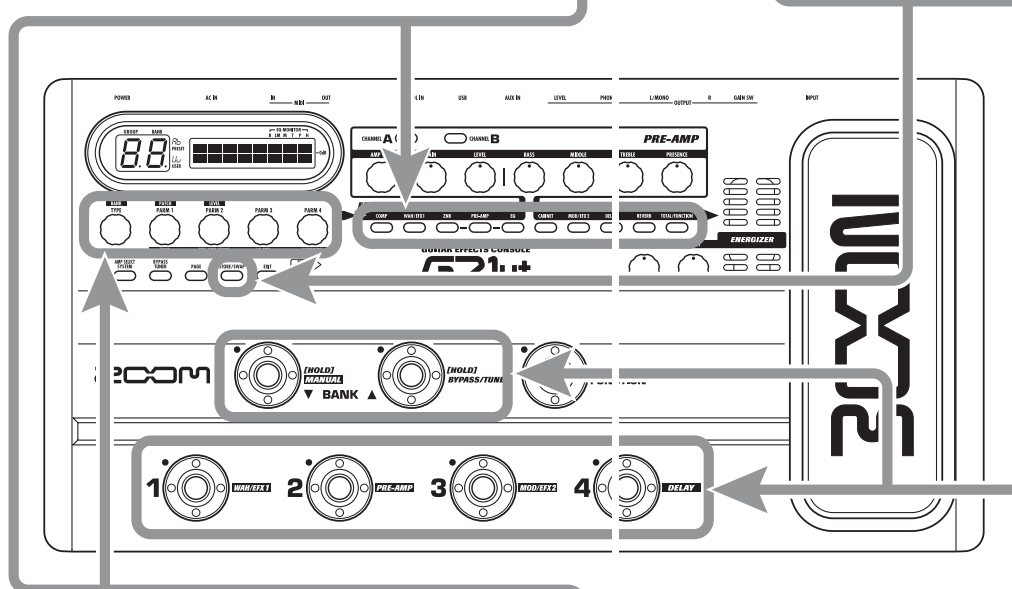

# Selecting Patches for Playing (Play Mode)

Immediately after you turn on the G7.1ut, it is always in the mode for selecting and using patches (play mode). The most recently used patch is automatically called up again. The various operation steps in play mode are described in this section.

## Panel display

In play mode, the following information is shown on the panel.

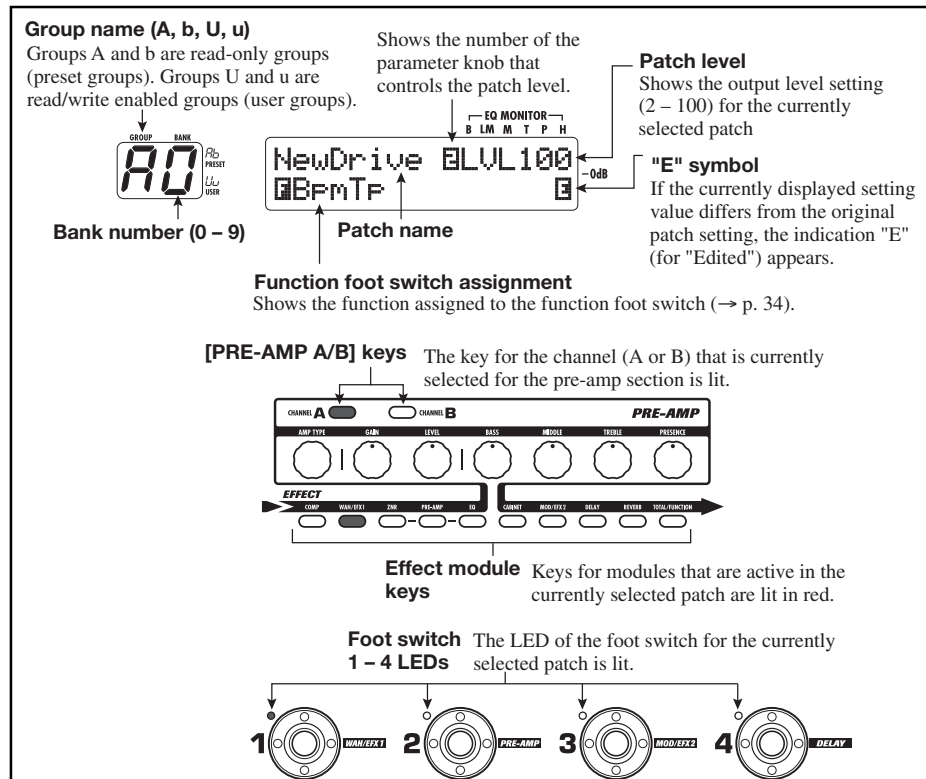

## Selecting a patch

This section explains how to select a patch in play mode.

1. Press a foot switch 1 - 4 whose LED is not lit.

The LED of the pressed switch lights up, indicating that a new patch has been called up.



## Adjusting the sound

In play mode, you can use the knobs on the panel to adjust the basic parameters of the pre-amp section (distortion type and intensity, EQ boost/cut etc.).

1. In play mode, select the patch.
2. Press one of the [PRE-AMP A/B] keys to select the pre-amp channel A or B for which to make the adjustment.



The pre-amp section of the G7.1ut has two separate channels which allow individual settings. Simply pressing one of the [PRE-AMP A/B] keys instantly switches the channel.

### HINT

You can switch between channel A and B with the [FUNCTION] (CH A/B) foot switch (→ p. 34).

3. To change the distortion type, turn the [AMP TYPE] knob.

The [AMP TYPE] knob selects the distortion type (the amp or compact effect that is being simulated). When you turn the knob, the name of the new amp type appears on the display.

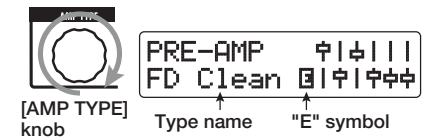

### HINT

- When you have changed the distortion type, the "E" symbol appears on the display, and the [STORE/SWAP] key lights up.
- If the currently displayed setting value differs from the original patch setting, the indication "E" (for "Edited") appears.

### HINT

- In play mode, you can select a patch by turning parameter knob 1.
- When you press a foot switch whose LED is lit, the same patch is called up once more.

2. To switch to a patch in another bank, use the BANK [▼]/[▲] foot switches to change the bank and then use foot switches 1 - 4 to select the patch.

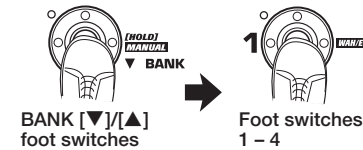

When you repeatedly press the BANK [▲] foot switch, the G7.1ut switches the group/bank as follows.

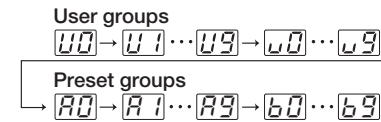

### HINT

In play mode, you can switch the group/bank by turning the [TYPE] knob.

### NOTE

- When using the BANK [▼]/[▲] foot switches to change banks, press and release the switch quickly.
- If you keep the BANK [▼] foot switch depressed for more than one second, the G7.1ut switches to manual mode (→ p. 18).
- If you keep the BANK [▲] foot switch depressed for more than one second, the G7.1ut switches to the bypass condition (effects off). If you keep the switch depressed further, the G7.1ut switches to the mute condition (original sound and effect sound both off) (→ p. 20).



- The lit [STORE/SWAP] key indicates that one or more items (including items not currently displayed) have been changed from the contents of the original patch. If all items are returned to their original settings, the key will go out.

**4. To change other major parameters in the pre-amp section, operate the respective knob (see illustration below).**

When you turn a knob, the name and the current setting of the respective parameter appear on the display. Operating the [BASS], [MIDDLE], [TREBLE], or [PRESENCE] knob will boost or cut the respective band, and the setting is reflected in the graph on the right side of the display.

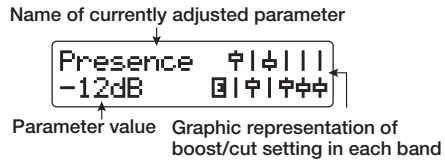

**HINT**

When you perform step 3 or step 4, the G7.1ut switches to edit mode. To return to play mode, press the [EXIT] key. (For details on edit mode, see page 23.)

**5. To adjust the overall level of the patch, turn parameter knob 2 in play mode.**



The patch level is a parameter that controls the output level of the respective patch. The setting range is 2 – 100. A setting of 80 results in unity gain (no level increase or decrease).

**NOTE**

The changes that you have made to a patch will be lost when you select another patch. To keep the changes, store the patch first (→ p. 27).

**Using the Energizer**

The G7.1ut incorporates an Energizer function that processes the analog output signal using a tube circuit.

This feature is suitable for making the guitar stand out in an ensemble setting, or for adding that characteristic tube distortion sound.

**HINT**

- The Energizer is active in all modes.
- The Energizer settings are not stored as part of the patch.

To adjust the Energizer, use the control knobs of the tube section on the panel. The control functions are explained below.

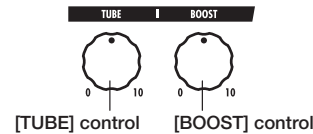

● **[TUBE] control**

This control adds characteristic tube distortion to the sound, making the guitar stand out more distinctly. When the knob is turned fully

counterclockwise, the effect is off. Turning the knob clockwise gradually increases the tube circuit gain, resulting in warmer, more solid crunch or drive sound. Normally, you should set the control to a position where distortion is not too audible, but you can set it higher when you purposely want to emphasize the tube distortion.

● **[BOOST] control**

This control boosts specific frequency bands to make the sound more pronounced. When the knob is turned fully counterclockwise, the effect is off. Turning the knob clockwise gradually boosts the low frequencies and the area around 2 kHz. Especially when using a small guitar amp or an audio system with flat response, this can be helpful to produce more dynamic sound.

The [BOOST] control is useful in such situations, and for bringing the sound of the guitar more to the foreground when playing in a band.

**NOTE**

- The intensity of the distortion achieved with the [TUBE] control depends on the guitar and type of pickup.
- When both controls are fully turned up, the volume level will be higher and excessive distortion may occur.

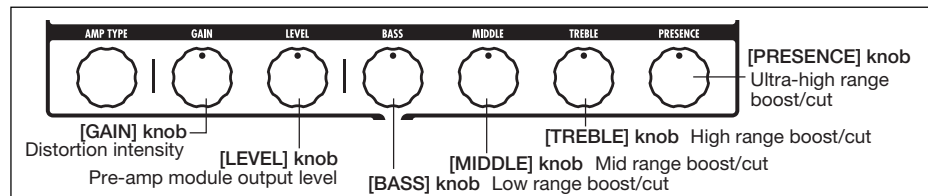

## Switching Modules On and Off With Your Foot During Play (Manual Mode)

The condition where foot switches 1 – 4 are used to switch the major modules in a patch on and off individually is called "manual mode". In this mode, the single effects of the G7.1ut can be controlled with your foot like independent compact effects.

**1. In play mode, select a patch.**

**2. Press and hold the BANK [▼] foot switch for at least 1 second.**



The LED of the BANK [▼] foot switch lights up and the G7.1ut switches to manual mode.

In manual mode, the following information appears on the panel (see illustration below).

### NOTE

In manual mode, you cannot use the foot switches to select patches. However, the [TYPE] knob (group/bank selection) and the parameter knob 1 (patch selection) operate in the same way as in play mode. Please note that you go back to "play mode" when you change patches.

**3. To switch a module between on and off, press the foot switch for that**

module.



### NOTE

The changes that you have made to a patch will be lost when you select another patch. To keep the changes, store the patch first (→ p. 27).

In manual mode, you can use foot switches 1 – 4 to switch the major effect modules on or off. The module/switch allocation is as follows.

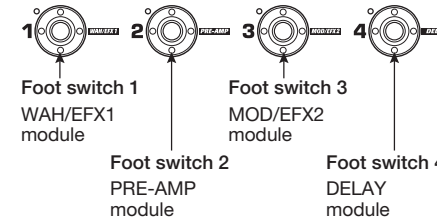

### HINT

- When a module is switched on/off, the [STORE/SWAP] key lights up.
- In manual mode, you can use the knobs on the panel as in play mode to adjust pre-amp parameters, patch level, and the tube energizer. For an explanation of operation procedures, see "Adjusting the sound" in the section on play mode (→ p. 15).
- From manual mode you can switch to edit mode for editing patches. For details on edit mode, see page 23.

**4. To return to play mode, press the BANK [▼] foot switch.**

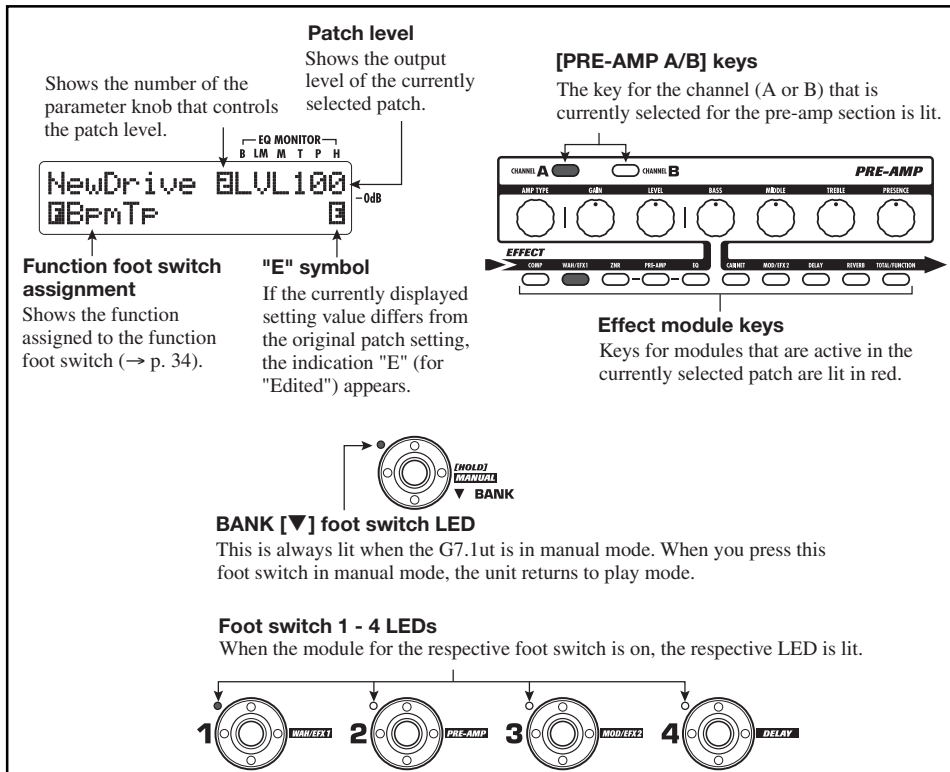

# Using the Internal Tuner (Bypass/Mute Condition)

The G7.1ut incorporates a tuner function that supports regular chromatic tuning as well as special tuning. This section explains the steps for using the tuner.

## Using the chromatic tuner

To use the chromatic tuner function, proceed as follows.

1. In play mode, manual mode, or edit mode, press and hold the BANK [▲] foot switch.

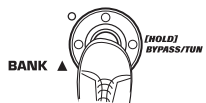

To use the tuner, the G7.1ut must be set to the bypass condition (effects off) or mute condition (original sound and effect sound both off).

### ● To switch to the bypass condition

Hold the BANK [▲] foot switch for about 1 second, until the indication "BYPASS" appears on the display. Then release the foot switch. The G7.1ut is now in the bypass condition.



### HINT

You can switch to the bypass condition by pressing the [BYPASS/TUNER] key.

### ● To switch to the mute condition

Hold the BANK [▲] foot switch until the indication "BYPASS" changes to "MUTE". Then release the foot switch. The G7.1ut is now in the mute condition.



After "BYPASS" or "MUTE" was shown, the display automatically switches to the tuning display.



### NOTE

You can switch to the mute condition by pressing and holding the [BYPASS/TUNER] key.

### HINT

- The built-in expression pedal functions as a volume pedal in the bypass condition (in the mute condition, the pedal has no effect).
- By turning the parameter knob 2, you can select other tuner types besides the chromatic tuner. For more information, see the next section.
- The number shown in reverse on the display indicates that the corresponding parameter knob can be used for adjustment.

## 2. Play the open string to tune.

The [GROUP/BANK] indicator shows the note which is closest to the current pitch.

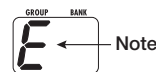

Note	[GROUP/BANK] indicator	Note	[GROUP/BANK] indicator
A <sup>b</sup>	A <sup>b</sup>	D	d
A	A	E <sup>b</sup>	E <sup>b</sup>
B <sup>b</sup>	b <sup>b</sup>	E	E
B	b	F	F
C	C	G <sup>b</sup>	G <sup>b</sup>
D <sup>b</sup>	d <sup>b</sup>	G	G

The > < symbols in the lower part of the display show by how much the pitch differs from the displayed note.

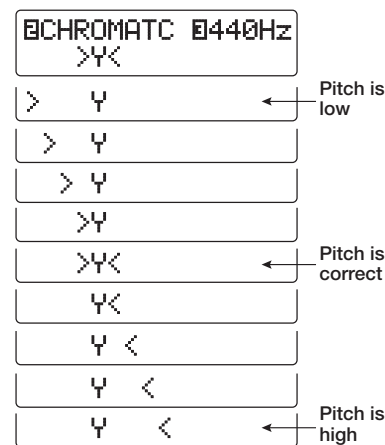

## 3. Tune the string of your instrument while checking the note and pitch indication.

### HINT

First you should perform rough tuning to bring up the desired note indication, and then watch the lower part of the display and fine tune the pitch.

## 4. To change the reference pitch of the tuner, turn parameter knob 3.

After the G7.1ut is turned on, the tuner reference pitch is always "440 Hz (center A = 440 Hz)". The adjustment range using parameter knob 3 is center A = 435 – 445 Hz, in 1-Hz steps.



### HINT

When the G7.1ut is turned off and on again, the reference pitch will be reset to 440 Hz.

## 5. When tuning is completed, press one of the BANK [▼]/[▲] foot switches.



The G7.1ut returns to the previous mode. If the G7.1ut was in edit mode, it will be switched to play mode.

### HINT

The bypass/mute condition can be canceled by pressing the [BYPASS/TUNER] key, [EXIT] key, or one of the foot switches 1 – 4.

## Using other tuner types

Besides chromatic tuning, the G7.1ut offers various other tuning types such as standard tuning for guitar and bass, open tuning, etc. To use these functions, proceed as follows.

### 1. Switch the G7.1ut to the bypass or mute condition as described in step 1 of "Using the chromatic tuner".

The display shows the tuning indication.

### 2. Turn parameter knob 2 to select the tuner type.

The available tuner types and the corresponding note names for each string are listed below.

If you select "OPEN A" as tuner type, the [GROUP/BANK] indicator and display indication will be as follows.

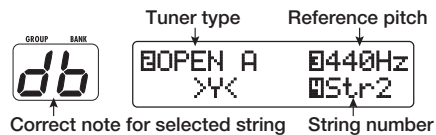

### 3. If necessary, turn parameter knob 3 to change the reference pitch of the tuner.

The setting range is center A = 435 – 445 Hz, in 1-Hz steps.

If "GUITAR" or "BASS" has been selected as tuner type, turning parameter knob 3 further anticlockwise from the "435" setting selects the

setting "b" (one semitone lower), "bb" (two semitones lower), and "bbb" (three semitones lower).

Optional tuning to 1 - 3 semitones lower



#### HINT

When the G7.1ut is turned off and on again, the reference pitch will be reset to 440 Hz.

### 4. Play the open string of the indicated number and adjust the pitch.

### 5. Turn parameter knob 4 to switch to other strings.

### 6. Tune other strings in the same way.

### 7. When tuning is completed, press one of the BANK [▼]/[▲] foot switches.

The G7.1ut returns to the previous mode. If the G7.1ut was in edit mode, it will be switched to play mode.

#### HINT

When the G7.1ut is turned off and on again, the tuner type setting will be reset to the default (chromatic tuner).

Tuner type	GUITAR	BASS	OPEN A	OPEN G	OPEN E	OPEN D	DADGAD
String number	STR1	E	G	E	d	E	d
	STR2	b	d	db	b	b	A
	STR3	G	A	A	G	Ab	Gb
	STR4	d	E	E	d	E	d
	STR5	A	b	A	G	b	A
	STR6	E		E	d	E	d
	STR7	b					

# Changing the Sound of a Patch (Edit Mode)

The condition where you can change the effect types and settings that make up a patch is called "edit mode". This section describes how to use this mode.

## Patch configuration

As shown in the "Patch configuration" illustration below, the G7.1ut can be thought of as a series of several single effects (effect modules). A combination of these modules and the settings for each module are stored as a patch.

Almost all modules comprise several different effects (called effect types), one of which is selected at any given time. For example, the MOD/EFX2 module allows selection of either CHORUS, PITCH SHIFTER, DELAY, etc.

The elements that determine the sound of a patch are called effect parameters. Each effect type has its own parameters that can be controlled with knobs on the panel. Even within the same module, when the effect type is different, the effect parameters that can be controlled will also be different.

In the module configuration shown below, the ZNR, PRE-AMP, EQ, and CABINET modules operate as a virtual pre-amp section. Depending on the application, this section can be inserted after the WAH/EFX1 module or after the DELAY module (→ p. 52). For the ZNR, PRE-AMP and EQ modules, different settings can be made in two channels (A/B).

## Basic edit mode steps

The basic steps that are normally taken in edit mode are explained here. For details on effect types and parameters for each module, see the section "Effect Types and Parameters" on page 54 – 67.

### 1. Select the patch to edit.

The patch can be from a preset group (A/b) or user group (U/u). However, if you have edited a patch from a preset group, it can only be stored in a user group (→ p. 27).

### 2. In play mode or manual mode, press the effect module key (see illustration on next page) to select the module on which to operate.

The G7.1ut switches to edit mode, and the display changes as follows.

#### [Module other than PRE-AMP/EQ]

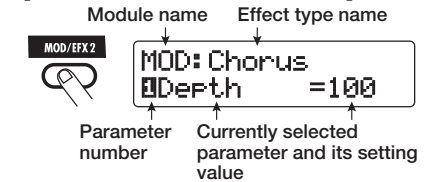

#### HINT

- On every display screen, the number shown in reverse indicates the parameter knob that can be used to adjust the parameter.

#### [Patch configuration]

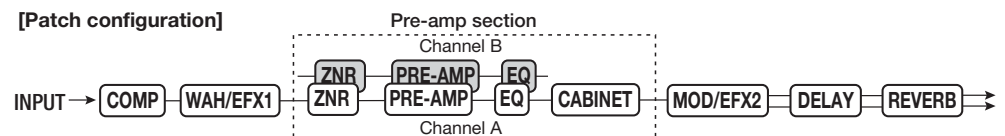

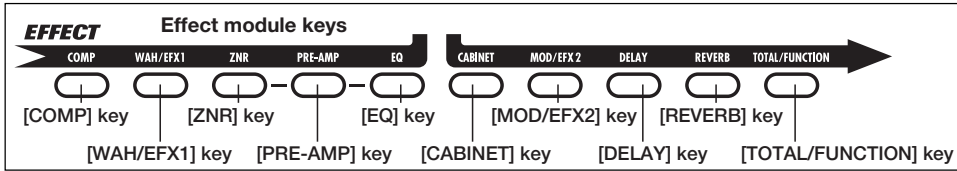

- The effect module keys for modules that are ON in the currently selected patch are lit in red (keys for modules that are OFF are not lit). When you press a key to select a module, the key color changes to orange (or to green if the module is off).

**[PRE-AMP module ]**

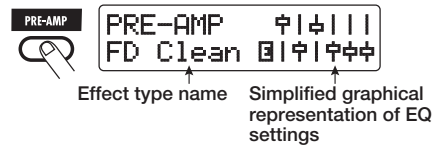

**[EQ module ]**

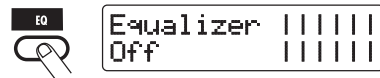

**NOTE**

- If edit mode was activated from play mode, foot switches 1 – 4 can be used to switch patches. However, note that editing changes will be lost when switching patches during editing.
- When edit mode was activated from manual mode, the foot switches 1 – 4 can be used to switch a specific module on or off.

**3. To switch the selected module between on and off, press the same module key once more.**

When the module is off, the indication "Module Off" is shown on the display. Pressing the same key once more in this condition switches the module on.

**HINT**

- If any module on/off status, effect type selection, or a parameter setting value has been changed at least once, the [STORE/SWAP] key lights up and the indication "E" appears next to the item.
- The "E" indication disappears when the item is returned to the original value. However, if any other item has been changed, the [STORE/SWAP] key remains lit.

**NOTE**

The PRE-AMP, ZNR, and EQ modules can be set to on or off separately for each channel (A/B).

**4. To edit the selected module, proceed as follows.**

**• When a module other than PRE-AMP/EQ is selected**

Switch the effect type as needed with the [TYPE] knob (for modules having several effect types), and use the parameter knobs 1 – 4 the adjust the parameters of the effect type. Which parameters are assigned to the parameter knobs 1 – 4 differs, depending on the module and effect type (→ p. 54 – 67).

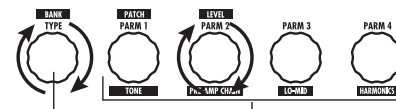

[TYPE] knob Parameter knobs 1 - 4

When you turn a parameter knob, the display changes as follows.



Number of operated parameter knob and parameter name

**HINT**

For effect modules with only one effect type (EQ module, CABINET module etc.), the effect type cannot be changed.

**• When PRE-AMP/EQ module is selected**

The PRE-AMP and EQ module parameters can always be adjusted with the knobs and keys of the pre-amp section, regardless of which module is currently selected. The functions of

the knobs and keys are listed in Figure 1 below.

When the effect module key [PRE-AMP]/[EQ] is selected, parameter knobs 1 – 4 can be used to adjust other parameters of the PRE-AMP/EQ module. The functions of the knobs are listed in Figure 2 below.

**HINT**

- When the PRE-AMP parameter of the pre-amp section is adjusted, the PRE-AMP module is automatically selected and the [PRE-AMP] key lights up in orange. When an EQ parameter is adjusted, the EQ module is automatically selected and the [EQ] key lights up in orange.
- The PRE-AMP, ZNR, and EQ modules allow separate parameter settings for the two channels (A/B). Select the channel first, and then adjust the parameter.

**Figure 1**  
[Editing PRE-AMP/EQ module with pre-amp section]

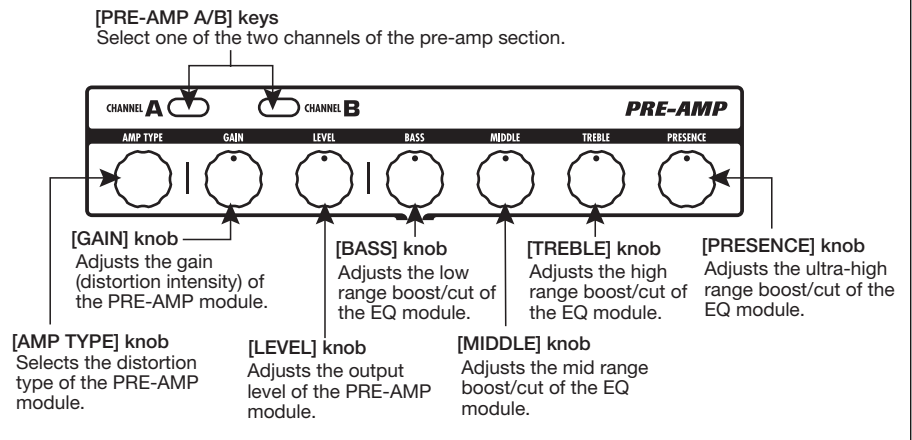

**Figure 2**  
[Editing PRE-AMP/EQ module with parameter knobs 1 – 4 ]

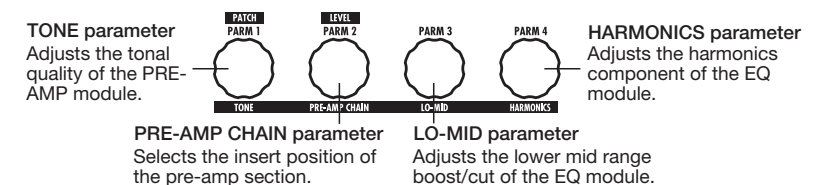



5. Repeat steps 2 – 4 to edit other modules in the same way.

6. When editing is finished, press the [EXIT] key.



The G7.1ut returns to the previous mode.

**NOTE**

- The changes that you have made to a patch will be lost when you select another patch. To keep the changes, store the patch first (→ p. 27).
- The patch level (output level of individual patch) cannot be changed in edit mode. Use play mode or manual mode to set the level.

**HINT**

- If edit mode was entered from play mode, you can return to play mode by pressing the BANK [▼]/[▲] foot switches or foot switches 1 – 4. In this case, the bank/patch will be switched at the same time.
- If edit mode was entered from manual mode, you can cancel the mode by pressing the BANK [▼] foot switch. The G7.1ut will then return to manual mode.

## Changing a patch name

You can change the name of an edited patch. To do this, proceed as follows.

1. In play mode, manual mode, or edit mode, press the [TOTAL/FUNCTION] effect module key.



2. Turn the [TYPE] knob to bring up the patch name on the lower part of the display.

The first character of the patch name is shown alternating with a black square.



The alternating black square (■) indicates that this character can be changed

3. Turn parameter knob 4 to move the character input position, and use parameter knobs 1 – 3 to select the new character.

Parameter knobs 1 – 3 select characters as follows.

Parameter knob 1 (numerals): 0 – 9

Parameter knob 2 (letters): A – Z, a – z

Parameter knob 3 (symbols):(space)

! " # \$ % & ' ( ) \* + , - . / : ; < > = ? @ [ ] ^ \_ ` { } | ¥ ← →

4. Repeat step 3 until the patch name is as desired. Then press the [EXIT] key.

# Storing Patches and Banks (Store Mode)

This section explains how to use the store mode. In store mode, you can store edited patches in memory, or swap the store location of user group patches. Storing and swapping can also be carried out for entire banks. The patches of the user groups can be returned to the factory default condition at any time.

## Storing/swapping patches

This section explains how to store and swap patches.

1. In play mode, manual mode, or edit mode, press the [STORE/SWAP] key.



The G7.1ut switches to the store standby condition, and the currently selected patch becomes the store/swap source.

The [GROUP/BANK] indicator shows the store/swap target group name and bank number.

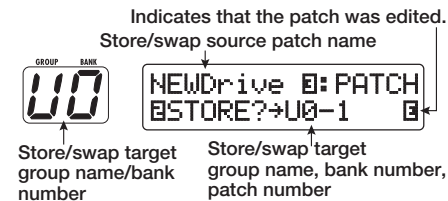

**HINT**

- In the factory default condition, the user groups (U, u) contain the same patches as the preset groups (A, b).
- If a patch has been edited, it will be stored or swapped in the edited condition.
- If a patch from a preset group was selected when you pressed the [STORE/SWAP] key, the first user group patch will automatically be selected as store target.

2. To store/swap individual patches, turn parameter knob 3 to bring up the indication "PATCH" in the top right of

the display.

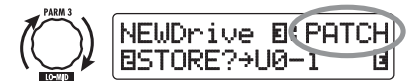

**NOTE**

When "BANK" is shown, the subsequent operation will be carried out for the entire bank. Make sure that the correct indication is shown.

3. Turn parameter knob 2 to bring up the indication "STORE?" or "SWAP?" on the display.



When "STORE?" is selected, the current patch can be stored as any user patch.

When "SWAP?" is selected, the current user patch can be swapped with any other user patch.

**NOTE**

If the source patch is from a preset group, the indication "SWAP?" does not appear.

4. Use the [TYPE] knob or BANK [▼]/[▲] foot switches to select the store/swap target group name/bank number.



- 5. Use parameter knob 1 or the foot switches 1 – 4 to select the store/swap target patch number.**



- 6. Press the [STORE/SWAP] key once more.**

The store/swap process is carried out, and the G7.1ut then returns to the play mode or manual mode with the store/swap target patch being selected.

By pressing the [EXIT] key instead of the [STORE/SWAP] key, you can cancel the process and return to the previous mode.

#### NOTE

The Energizer settings are not stored as part of the patch.

## Storing/swapping banks

This section explains how to store and swap entire banks.

- 1. In play mode, manual mode, or edit mode, press the [STORE/SWAP] key.**

The G7.1ut switches to the store standby condition, and the currently selected bank becomes the store/swap source.

- 2. To store/swap entire banks, turn parameter knob 3 to bring up the indication "BANK" in the top right of the display.**

Store/swap source group name/bank number



Store/swap target group name/bank number

Store/swap target group name/bank number

- 3. Turn parameter knob 2 to bring up the indication "STORE?" or "SWAP?" on the display.**

When "STORE?" is selected, the current bank can be stored as any user bank.

When "SWAP?" is selected, the current user bank can be swapped with any other user bank.

#### NOTE

If the source bank is from a preset group, the indication "SWAP?" does not appear.

- 4. Use the [TYPE] knob or BANK [▼]/[▲] foot switches to select the store/swap target bank.**

- 5. Press the [STORE/SWAP] key once more.**

The store/swap process is carried out, and the G7.1ut then returns to play mode or manual mode with the store/swap target bank being selected.

By pressing the [EXIT] key instead of the [STORE/SWAP] key, you can cancel the process and return to the previous mode.

## Returning patches to factory default condition

Even if you have made changes to the user group patches, you can return all patches to the factory default condition at any time. To do this, proceed as follows.

- 1. Turn power to the G7.1ut on while holding down the [STORE/SWAP] key.**



The indication "All Initialize?" appears on the display.

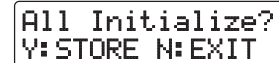

- 2. Press the [STORE/SWAP] key once more.**

All patches are returned to the factory default condition, and the G7.1ut switches to play mode. By pressing the [EXIT] key before performing step 2, you can cancel the process.

# Using the Expression Pedal

This section explains how to use the built-in and an external expression pedal.

## About the built-in expression pedal

The G7.1ut has an integrated expression pedal that can be used to control specific effect parameters in real time.

The pedal has four control targets (PDL1 – PDL4), which makes it possible to adjust up to four parameters simultaneously. A setting example is shown below, to give you an idea of how the pedal can be used.

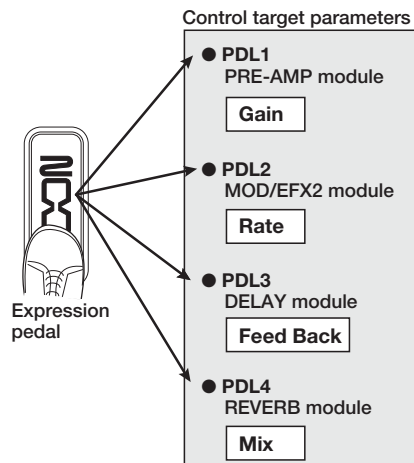

### HINT

- The parameter adjustment range covered by the pedal can be set for each control target separately.
- In bypass mode, the built-in expression pedal functions as a volume pedal. (In mute mode, the pedal has no effect.)

## Assigning control targets to the built-in expression pedal

To assign a control target to the built-in expression pedal, proceed as follows.

### 1. In play mode, select the patch.

#### HINT

The parameters to be controlled by the built-in expression pedal and the setting range can be set separately for each patch.

### 2. Press the [PEDAL SETTING] key.

The display changes as follows.

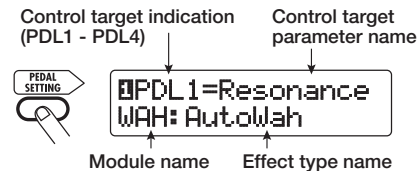

#### HINT

The expression pedal setting is included in the TOTAL/FUNCTION module for the respective patch. The above display can also be called up by pressing the [TOTAL/FUNCTION] effect module key and turning the [TYPE] knob.

### 3. Turn the [TYPE] knob to select one of the four control targets (PDL1 – PDL4).



The subsequent operation steps are the same for PDL1 – PDL4.

### 4. Turn parameter knob 1 to select the parameter that is to be controlled.



As you turn parameter knob 1, the effect parameter, effect type, and effect module changes.

#### HINT

- For information on which parameters can be selected as control targets, see “Effect Types and Parameters” on page 54 – 67.
- When “Volume” is selected as control target, the built-in expression pedal functions as a volume pedal.
- When “NOT Assign” is displayed, no parameter is assigned to the current control target. By setting all four control targets to “NOT Assign”, the expression pedal can be defeated.

#### NOTE

If you select “NOT Assign”, steps 5 and 6 cannot be carried out.

### 5. To set the adjustment range for the parameter to be controlled, use parameter knob 2 (minimum value) and parameter knob 3 (maximum value).

The settings selected with parameter knobs 2 and 3 determine the value when the pedal is fully raised (minimum value) and fully depressed (maximum value).

The display changes as follows.

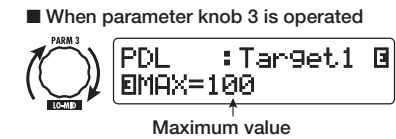
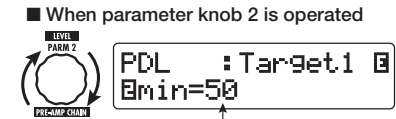

#### HINT

- The available range setting depends on the parameter selected in step 4.
- It is also possible to set “min” to a higher value than “MAX”. In that case, the parameter value will be minimum when the pedal is fully depressed and maximum when the pedal is fully raised.

### 6. To use the built-in expression pedal for switching the module on and off, turn parameter knob 4 and select “Enable”.

The built-in expression pedal of the G7.1ut has a switch that is triggered when the pedal is pushed a bit further, after the fully down position is reached. The module to which the selected parameter belongs will be switched on or off.

When you turn parameter knob 4, the display changes as follows.

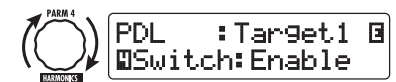

#### HINT

If you select “Disable” at the above display, module on/off switching is not available.

### 7. Repeat steps 3 – 6 to set the other control targets in the same way.

**NOTE**

It is also possible to specify the same parameter for more than one control target, but in some cases, extreme parameter value changes may lead to noise. This is not a defect.

- 8. When all settings for the built-in expression pedal have been made, press the [EXIT] key.**



The unit returns to play mode.

- 9. If required, store the patch.**

**NOTE**

Any changes in pedal settings will be lost when you select a new patch. Be sure to store the patch if you want to keep the changes (→ p. 27).

## Adjusting the built-in expression pedal

The built-in expression pedal of the G7.1ut is adjusted for optimum operation at the factory, but sometimes, readjustment may be necessary. If the action of the pedal seems to be insufficient, or if a large change occurs even if the pedal is only lightly pushed, adjust the pedal as follows.

- 1. Hold down the [PEDAL SETTING] key while turning on power to the unit.**

The display indication changes as follows.

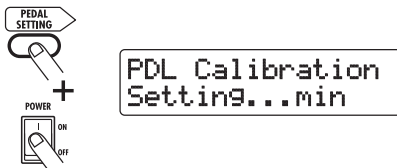

- 2. With the expression pedal fully raised, press the [STORE/SWAP] key.**

The display indication changes as follows.

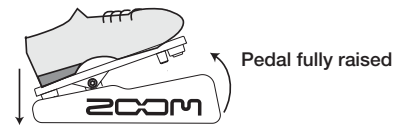

- 3. Push the expression pedal fully down and then lift your foot off the pedal.**

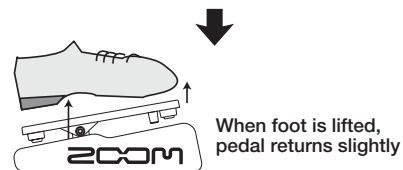

- 4. Press the [STORE/SWAP] key.**



The adjustment is completed, and the unit returns to the play mode.

**HINT**

- The module on/off switching point is not affected by the pedal position in step 3.
- For information about the module on/off switching function, see page 31.
- If the indication "ERROR" appears, return to step 2 and repeat the procedure.

## Using an external expression pedal

An optional expression pedal (FP01/FP02) can be connected to the CONTROL IN jack of the G7.1ut and used independently from the built-in expression pedal as a volume pedal.

- 1. Plug the external expression pedal into the CONTROL IN jack and turn power to the G7.1ut on.**

- 2. Operate the external expression pedal in play mode, manual mode, or edit mode.**

The volume level changes.

**HINT**

The external expression pedal always functions as a volume pedal. It can also be used as a controller for sending MIDI messages (→ p. 41).

# Using the Function Foot Switch

The G7.1ut provides a programmable [FUNCTION] (CH A/B) foot switch on the top panel. You can select one from a range of functions, assign it to the switch, and store the setting for each patch individually.

## 1. In play mode, select the patch.

### HINT

The [FUNCTION] (CH A/B) foot switch assignment can be set separately for each patch.

## 2. Press the [TOTAL/FUNCTION] effect module key.

The [FUNCTION] (CH A/B) foot switch assignment is part of the [TOTAL/FUNCTION] module.

The display changes as follows.

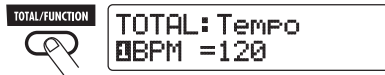

## 3. Turn parameter knob 2 to select the function to be assigned to the [FUNCTION] (CH A/B) foot switch.

When you turn parameter knob 2, the display changes as follows.

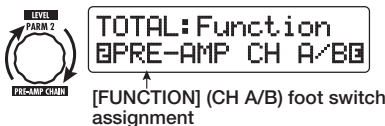

The following functions can be assigned to the [FUNCTION] (CH A/B) foot switch.

### ● PRE-AMP CH A/B

The [FUNCTION] (CH A/B) foot switch toggles between the pre-amp channels A and B.

### ● BPM TAP

The [FUNCTION] (CH A/B) foot switch can be used to specify the individual tempo for a patch (→ p. 35). When the switch is pressed

repeatedly, the interval between the last two presses is taken as the new tempo setting.

### HINT

Using the tempo set here, specific parameters (Time and Rate) can be synchronized in note units (→ p. 35).

### ● Delay TAP

The [FUNCTION] (CH A/B) foot switch can be used to specify the Time parameter for the DELAY module.

### HINT

- While BPM TAP specifies the tempo for an individual patch, DELAY TAP uses the foot switch operation interval to directly set the Time parameter value (delay time).
- To use Delay TAP, the DELAY module must be active for that patch.

### ● Hold Delay

The [FUNCTION] (CH A/B) foot switch toggles hold delay between on and off. When you press the [FUNCTION] (CH A/B) foot switch in a patch for which hold delay is active, the hold function is turned on and the current delay sound is repeated. Pressing the [FUNCTION] (CH A/B) foot switch once more cancels hold, and the delay sound will decay naturally (see illustration on next page).

### HINT

To use Hold Delay, the DELAY module must be active for that patch.

### ● Delay Mute

The [FUNCTION] (CH A/B) foot switch toggles DELAY module input muting between on and off.

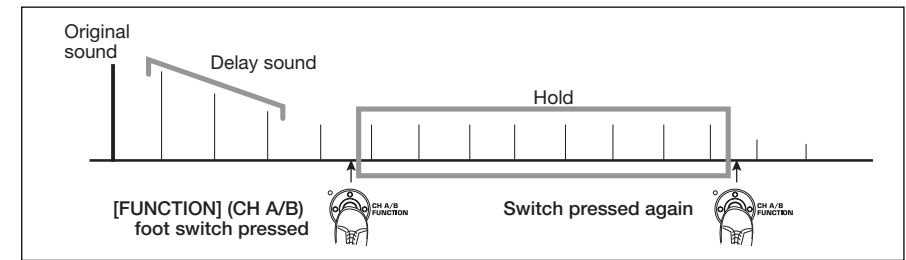

### ● Bypass OnOff, Mute OnOff

The [FUNCTION] (CH A/B) foot switch toggles the bypass mode or mute mode between on and off. When either mode is activated, the tuner display comes up.

### ● Manual Mode

The [FUNCTION] (CH A/B) foot switch toggles between play mode and manual mode.

### ● COMP OnOff, WAH/EFX1 OnOff, ZNR OnOff, PRE-AMP OnOff, EQ OnOff, MOD/EFX2 OnOff, DELAY OnOff, REVERB OnOff

The [FUNCTION] (CH A/B) foot switch toggles the respective module between on and off.

### HINT

When you select "PRE-AMP CH A/B", the LED of the [FUNCTION] (CH A/B) foot switch lights up in red (A) or green (B). When you select "BPM TAP" or "Delay TAP", the LED flashes orange in sync with the BPM setting. When other functions are selected, the LED is lit in orange.

## 4. After selecting a function to assign to the [FUNCTION] (CH A/B) foot switch, press the [EXIT] key.



The unit returns to play mode.

### NOTE

Any changes in assignment settings will be lost when you select a new patch. Be sure to store the patch if you want to keep the changes (→ p. 27).

When you next call up the stored patch, the [FUNCTION] (CH A/B) foot switch will control the selected function.

## Specifying the tempo for a patch

The G7.1ut lets you specify a tempo for each individual patch and synchronize specific parameters to this tempo in note units. This section explains how to specify and use the tempo setting for a patch.

## 1. In play mode, select the patch.

## 2. Press the [TOTAL/FUNCTION] effect module key.

The tempo setting for each patch is part of the [TOTAL/FUNCTION] module.

When you press the [TOTAL/FUNCTION] effect module key, the current tempo setting appears on the display.

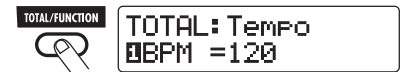

## 3. Turn parameter knob 1 to set the tempo.

The tempo setting range is 40 – 250.



- To synchronize a parameter to the specified tempo, select the effect type and effect parameter to synchronize, and select the note symbol as the setting value for the parameter.

The setting value for effect parameters which support tempo synchronization can be selected in note units, using the patch specific tempo as a reference.

For example, the Time parameter of the effect type TAPE ECHO in the MOD/EFX2 module supports patch specific tempo synchronization. To use this capability, turn the respective parameter knob from the maximum setting (2000) further clockwise until a note symbol appears on the display.

#### HINT

In the section “Effect Types and Parameters” (→ p. 54 – 67), parameters which support tempo synchronization are indicated by a note symbol.

- Select a parameter value by selecting a note symbol.

The following settings are available.

	Thirty-second note
	Sixteenth note
	Quarter triplet note
	Dotted sixteenth note
	Eighth note
	Half triplet note
	Dotted eighth note
	Quarter note
	Dotted quarter note
	Quarter note x 2
:	:
	Quarter note x 20

#### NOTE

The actual available setting range depends on the parameter.

When you have selected the eighth note setting, the Time parameter will be set to a value that corresponds to an eighth note in the patch specific tempo. When the tempo is changed, the delay time also changes accordingly.

#### NOTE

Depending on the combination of tempo setting and selected note symbol, the maximum of the parameter setting range (such as 2000 ms) may be exceeded. In such a case, the value is automatically halved (or set to 1/4 if the range is still exceeded).

- When the tempo and parameter setting is complete, press the [EXIT] key.

The unit returns to play mode. Store the patch as necessary.

The above procedure uses the tempo set in step 3 as reference for the note setting made in step 5. If the “BPM TAP” function is assigned to the [FUNCTION] (CH A/B) foot switch, you can specify the tempo with your foot during a performance and have the parameter change accordingly.

## MIDI Usage Examples

This section describes the various MIDI functions of the G7.1ut.

### What you can do with MIDI

The G7.1ut lets you use MIDI in various ways, as described below.

- Send and receive patch switching information via MIDI

When you switch patches at the G7.1ut, the MIDI OUT connector carries the corresponding MIDI messages (program change, or bank select + program change). Similarly, when a valid MIDI message is received at the MIDI IN connector, the G7.1ut will perform the corresponding patch switch action.

This makes it possible to have patches at the G7.1ut switched automatically under control of a MIDI sequencer, or link operation of the G7.1ut to patch switching at other MIDI enabled devices.

- Send and receive pedal/switch/key operation information via MIDI

When you operate specific keys and foot switches of the G7.1ut, or operate the built-in or an external expression pedal, the MIDI OUT connector carries the corresponding MIDI messages (control change). Similarly, when a valid MIDI message is received at the MIDI IN connector, the G7.1ut will vary the corresponding parameter.

This makes it possible to use the G7.1ut as a real-time controller for other MIDI enabled devices, or alter effect parameters and module on/off status under control of a MIDI sequencer, synthesizer, or other MIDI enabled device.

- Exchange patch data between two G7.1ut units via MIDI

The patch data of the G7.1ut can be output as MIDI messages (system exclusive), for copying to another G7.1ut.

### Selecting the MIDI channel

To enable correct sending and receiving of program change, control change and other MIDI messages, the MIDI channel (1 – 16) setting of the G7.1ut and the other MIDI device must be matched. To set the MIDI channel of the G7.1ut, proceed as follows.

- In play mode, press the [AMP SELECT/SYSTEM] key.

The AMP SELECT/SYSTEM menu for parameters that apply to all patches appears.



- Turn the [TYPE] knob to select the “MIDI Rx Ch” (MIDI receive channel) parameter.

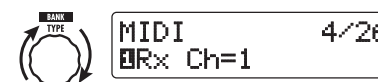

- Turn parameter knob 1 to select the MIDI channel (1 – 16) on which the G7.1ut will receive MIDI messages.

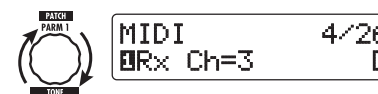

- Turn the [TYPE] knob to select the “MIDI Tx Ch” (MIDI transmit channel) parameter.

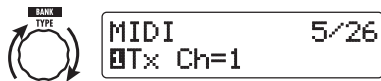

5. Turn parameter knob 1 to select the MIDI channel (1 – 16) on which the G7.1ut will send MIDI messages.

6. When the setting is complete, press the [EXIT] key to exit the AMP SELECT/SYSTEM menu.

The indication “Store...?” appears on the display, to allow you to store the changes.



7. Press the [STORE/SWAP] key to save the changes.



The MIDI channel setting is accepted, and the unit returns to play mode.

In the above condition (while “Store...?” is shown), only the [STORE/SWAP], [EXIT], and [PAGE] keys are active. By pressing the [EXIT] key, you can abort the changes and return to play mode without saving.

## Sending and receiving patch switching information via MIDI (program change)

You can send and receive patch changing information of the G7.1ut via MIDI as program change or bank select + program change messages.

There are two ways (program change modes) for doing this, as described below.

### ● Direct mode

With this method, you use a combination of MIDI bank select and program change messages to specify the patch. In the factory default condition, all patches of the G7.1ut are assigned a MIDI bank number and MIDI program change number. These can be used to directly specify each patch.

### HINT

- Bank select is a MIDI message type for specifying the sound category of a synthesizer or similar. It is used in combination with program change messages.
- Normally, bank select is specified in two parts, using the MSB (most significant bit) and LSB (least significant bit) value.

### ● Mapping mode

With this method, you use only the MIDI program change messages to specify the patch. A program change map is used to assign program change numbers 0 – 127 to patches, and patches are then selected using the mapping information. With this method, a maximum of 128 patches can be specified.

### ■ Enable program change send/receive

The procedure for enabling send/receive of program change (+ bank select) messages is described below.

1. In play mode, press the [AMP SELECT/SYSTEM] key.



2. To enable the G7.1ut to receive program change (+ bank select) messages, turn the [TYPE] knob to bring up the “MIDI PC Rx” (receive program change) parameter and turn parameter knob 1 to select the “ON” setting.

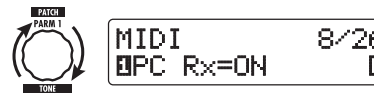

3. To enable the G7.1ut to send program change (+ bank select) messages, turn the [TYPE] knob to bring up the “MIDI PC Tx” (send program change) parameter and turn parameter knob 1 to select the “ON” setting.

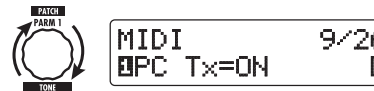

4. When the setting is complete, press the [EXIT] key to exit the AMP SELECT/SYSTEM menu.

The indication “Store...?” appears on the display, to allow you to store the changes.



5. Press the [STORE/SWAP] key to save the changes.

The setting is accepted, and the unit returns to play mode.

In the above condition (while “Store...?” is

shown), only the [STORE/SWAP], [EXIT], and [PAGE] keys are active. By pressing the [EXIT] key, you can abort the changes and return to play mode without saving.

### ■ Using direct mode

By using a combination of MIDI bank select and program change messages, you can specify a patch directly.

### NOTE

Before carrying out the following steps, verify that the send/receive MIDI channel setting of the G7.1ut is as required (→ p. 37), and that send/receive of program change messages is enabled (→ p. 39).

1. In play mode, press the [AMP SELECT/SYSTEM] key.



2. Turn the [TYPE] knob to bring up the “MIDI PCMODE” (program change mode) parameter.



3. Verify that “DIRECT” is selected as program change mode.

If not, turn parameter knob 1 to change the indication to “DIRECT”. This enables direct selection of patches using bank select and program change messages.

### HINT

For information on which bank number/program change number is assigned to each patch, see the list at the end of this manual (→ p. 71).

4. When the setting is complete, press the [EXIT] key to exit the AMP

**SELECT/SYSTEM menu.**

If any setting on the AMP SELECT/SYSTEM menu has been changed, the indication “Store...?” appears on the display, to allow you to store the changes.

**5. Press the [STORE/SWAP] key to save the changes.**

The setting is accepted, and the unit returns to play mode.

In the above condition (while “Store...?” is shown), only the [STORE/SWAP], [EXIT], and [PAGE] keys are active. By pressing the [EXIT] key, you can abort the changes and return to play mode without saving.

**6. To send and receive program change (+ bank select) messages, connect the G7.1ut and the other MIDI device as follows.**

**■ Example for sending program change (+ bank select) messages**

(2) Program change (+ bank select) message is sent

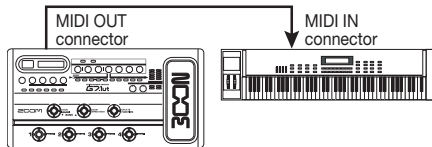

(1) When a patch at the G7.1ut is switched...

**■ Example for receiving program change (+ bank select) messages**

(1) When a program change (+ bank select) message is received...

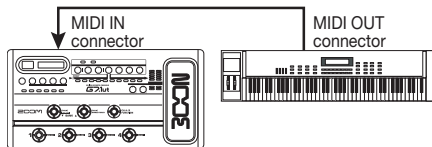

(2) Patch at the G7.1ut is switched.

**HINT**

- When the program change mode of the G7.1ut is set to “DIRECT”, and the external MIDI device sends only the MSB or LSB of the bank select message, the most recently received complete bank select instruction (initial values: MSB = 0, LSB = 0) will be used.
- When the external MIDI device sends only the program change message without bank select MSB and LSB, the same as above applies, namely the most recently received complete bank select instruction (initial values: MSB = 0, LSB = 0) will be used.

**NOTE**

When the external MIDI device sends only a bank select message to the G7.1ut, no change occurs. The next time the G7.1ut receives a program change, the most recent bank select instruction will be used.

**■ Using mapping mode**

In this mode, a program change map is used to assign patches, allowing patches to be specified by using program change messages only.

**NOTE**

Before carrying out the following steps, verify that the send/receive MIDI channel setting of the G7.1ut is as required (→ p. 37), and that send/receive of program change messages is enabled (→ p. 39).

**1. In play mode, press the [AMP SELECT/SYSTEM] key.**

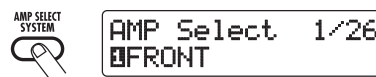

**2. Turn the [TYPE] knob to bring up the “MIDI PCMODE” (program change mode) parameter.**



**3. Turn parameter knob 1 to bring up the indication “MAPPING”.**

Patches can now be specified using program change messages according to the program change map.



**4. Turn the [TYPE] knob to bring up the “PC MAP” (program change map) parameter.**

Using this display, you can assign any patch of the G7.1ut to a program change number from 0 – 127.

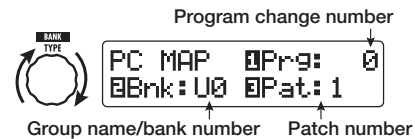

**5. To assign a patch to a program change number, proceed as follows.**

- (1) Turn parameter knob 1 until the program change number to use is shown on the top line of the display.

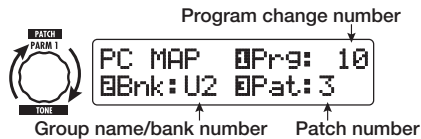

- (2) Use parameter knobs 2 and 3 to select the group name/bank number and patch number to assign to the program change number.



- (3) Repeat these steps to for other program change numbers.

**6. When the setting is complete, press the [EXIT] key to exit the AMP SELECT/SYSTEM menu.**

The indication “Store...?” appears on the display, to allow you to store the changes.

**7. Press the [STORE/SWAP] key to save the changes.**

The setting is accepted, and the unit returns to play mode.

In the above condition (while “Store...?” is shown), only the [STORE/SWAP], [EXIT], and [PAGE] keys are active. By pressing the [EXIT] key, you can abort the changes and return to play mode without saving.

**8. To send and receive program change messages, proceed as described in step 6 of “Using direct mode” (→ p. 39).**

**Sending and receiving pedal/switch/key operation information via MIDI (control change)**

The G7.1ut allows sending and receiving control change messages via MIDI. These messages govern actions such as operating the built-in or an external expression pedal and switching modules or bypass/mute on and off with keys and foot switches. Each action can be assigned its own control change number (CC#).

## ■ Enable control change send/receive

The procedure for enabling send/receive of control change messages is described below.

1. In play mode, press the [AMP SELECT/SYSTEM] key.



2. To enable the G7.1ut to receive control change messages, turn the [TYPE] knob to bring up the "MIDI CTRL Rx" (receive control change) parameter and turn parameter knob 1 to select the "ON" setting.



3. To enable the G7.1ut to send control change messages, turn the [TYPE] knob to bring up the "MIDI CTRL Tx" (send control change) parameter and turn parameter knob 1 to select the "ON" setting.



4. When the setting is complete, press the [EXIT] key to exit the AMP SELECT/SYSTEM menu.

The indication "Store...?" appears on the display, to allow you to store the changes.



5. Press the [STORE/SWAP] key to save the changes.

The setting is accepted, and the unit returns to play mode.

In the above condition (while "Store...?" is shown), only the [STORE/SWAP], [EXIT], and [PAGE] keys are active. By pressing the [EXIT] key, you can abort the changes and return to play mode without saving.

## ■ Assigning control change numbers

You can assign control change numbers to the expression pedal and keys of the G7.1ut as follows.

### NOTE

Before carrying out the following steps, verify that the send/receive MIDI channel setting of the G7.1ut is as required (→ p. 37), and that send/receive of control change messages is enabled (→ p. 41).

1. In play mode, press the [AMP SELECT/SYSTEM] key.



2. Turn the [TYPE] knob to bring up the display for assigning a control change number.

Operations to which a control change number can be assigned are listed in the table on the next page.

For example, to assign a control change number to the built-in expression pedal, the following display is used.

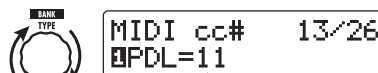

Control change number to be assigned

Display	Control target	Default CC#	CC# setting range
CTRL IN	External expression pedal operation	7	OFF, 1 – 5, 7 – 31, 64 – 95
PDL	Built-in expression pedal operation	11	OFF, 1 – 5, 7 – 31, 64 – 95
COMP	COMP module on/off	64	OFF, 64 – 95
WAH/EFX1	WAH/EFX1 module on/off	65	OFF, 64 – 95
ZNR	ZNR module on/off	66	OFF, 64 – 95
PRE-AMP	PRE-AMP module on/off	67	OFF, 64 – 95
EQUALIZER	EQ module on/off	68	OFF, 64 – 95
MOD/EFX2	MOD/EFX2 module on/off	69	OFF, 64 – 95
DELAY	DELAY module on/off	70	OFF, 64 – 95
REVERB	REVERB module on/off	71	OFF, 64 – 95
MUTE	Mute mode on/off	72	OFF, 64 – 95
BYPASS	Bypass mode on/off	73	OFF, 64 – 95
CH A/B	Pre-amp section channel A/B switching	74	OFF, 64 – 95

### HINT

The control change number assignment always applies both for sending and receiving.

3. Turn parameter knob 1 to specify a control change number.

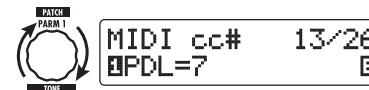

4. Assign control change numbers to other operations in the same way.

5. When the setting is complete, press the [EXIT] key to exit the AMP SELECT/SYSTEM menu.

The indication "Store...?" appears on the display, to allow you to store the changes.

6. Press the [STORE/SWAP] key to save the changes.

The setting is accepted, and the unit returns to play mode.

In the above condition (while "Store...?" is shown), only the [STORE/SWAP], [EXIT], and [PAGE] keys are active. By pressing the [EXIT] key, you can abort the changes and return to play

mode without saving.

7. To send and receive control change messages, connect the G7.1ut and the other MIDI device as follows.

### ■ Example for sending control change messages

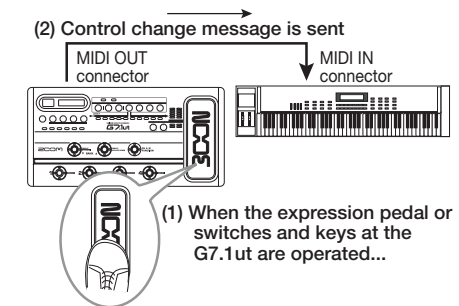

Control change values sent from the G7.1ut change as follows.

### ● When the built-in or external expression pedal is operated

The value of the assigned control change number is varied continuously over the range of 0 – 127.

### ● When module on/off switching is performed

When the module is set to on, the value 127 of the control change number is sent. When the module is set to off, the value 0 of the control change number is sent.

### ● When bypass/mute on/off switching is performed

When bypass/mute is set to on, the value 127 of the control change number is sent. When bypass/mute is set to off, the value 0 of the control change number is sent.

### ● When pre-amp section channel A/B switching is performed

When switching to channel A, the value 0 of the control change number is sent. When switching to channel B, the value 127 of the control change number is sent.

### ■ Example for receiving control change messages

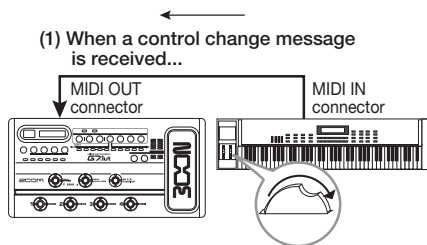

(2) The same operation as when the respective expression pedal or switch or key at the G7.1ut is operated occurs.

According to the control change value received, the G7.1ut status and parameter values change as follows.

### ● When control change for built-in/external expression pedal is received

The value of the parameter assigned to the pedal changes according to the control change value (0 – 127).

### ● When control change for module on/off is received

If control change value is between 0 and 63, the module is switched off. If control change value is between 64 and 127, the module is switched on.

### ● When control change for bypass/mute on/off is received

If control change value is between 0 and 63, bypass/mute is switched off. If control change value is between 64 and 127, bypass/mute is switched on.

### ● When control change for pre-amp section channel A/B switching is received

If control change value is between 0 and 63, the G7.1ut switches to channel A. If control change value is between 64 and 127, the G7.1ut switches to channel B.

## Sending and receiving G7.1ut internal data via MIDI

The patch data stored in a G7.1ut can be sent and received as MIDI messages (system exclusive). When two G7.1ut units are connected via a MIDI cable, this allows copying of patch data from the sending unit to the receiving unit.

### NOTE

When patch data are received, all existing patch data in the G7.1ut will be overwritten. Perform the following steps with care, to avoid accidentally overwriting important data.

1. Using two MIDI cables, connect the MIDI OUT and MIDI IN connectors on the source G7.1ut to the MIDI IN and MIDI OUT connectors on the target G7.1ut.

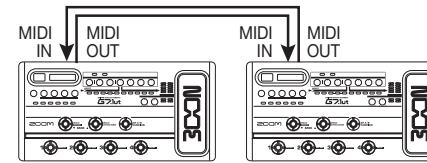

The steps at the source G7.1ut and target G7.1ut are explained separately below.

### ■ Source G7.1ut

2. Set the G7.1ut to play mode and press the [AMP SELECT/SYSTEM] key.



3. Use the [TYPE] knob to bring up the "BulkDumpTX" (bulk dump transmit) parameter on the display.



4. Press the [PAGE] key.

The G7.1ut is switched to bulk dump source operation. In this condition, the G7.1ut will automatically send patch data when it receives a MIDI message requesting data.

To return to the previous condition, press the [EXIT] key.

### ■ Target G7.1ut

5. Set the G7.1ut to play mode and press the [AMP SELECT/SYSTEM] key. Then use the [TYPE] knob to bring up the "BulkDumpRX" (bulk dump receive) parameter on the display.



6. Press the [PAGE] key.

The G7.1ut is switched to bulk dump target operation, and a MIDI message requesting data is sent to the source G7.1ut.

When the source G7.1ut receives this message, it automatically sends patch data from the MIDI OUT connector. The data are received by the target G7.1ut, and the display changes as follows.



### HINT

If you press the [EXIT] key before the indication "Receiving..." appears, the patch data send/receive operation is aborted and the previous display returns.

When the patch data send/receive process is completed, both G7.1ut units return to the AMP SELECT/SYSTEM menu.

### HINT

The web site of ZOOM CORPORATION (<http://www.zoom.co.jp>) has editor/librarian software available for download. Using this software, you can store patch data of the G7.1ut on a computer.



# Other Functions

## Using the ARRM function

The G7.1ut incorporates an innovative feature called ARRM (Auto-Repeat Real-time Modulation) which uses various internally generated control waveforms to cyclically modify effect parameters. You can select for example a triangular waveform and apply it to the wah frequency as a control target. The resulting effect is shown below.

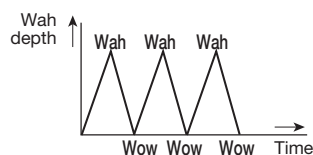

This section explains the use of the ARRM feature.

### 1. In play mode, select the patch.

#### HINT

The ARRM settings can be made separately for each patch.

### 2. Press the [TOTAL/FUNCTION] effect module key to switch to edit mode, and then turn the [TYPE] knob to bring up the indication "ARRM" on the display.

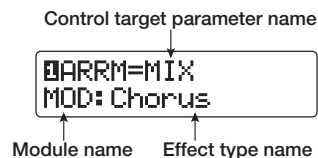

### 3. Turn parameter knob 1 to select the control target parameter.



As you turn parameter knob 1, the effect parameter, effect type, and effect module change.

#### HINT

- The parameters that can be selected as control targets are the same as can be selected for operation by the expression pedal. See the section "Effect Types and Parameters" on page 54 – 67.
- When "NOT Assign" is displayed, no parameter is assigned as control target and the ARRM function is disabled.

### 4. To set the adjustment range for the parameter to be controlled, use parameter knob 2 (minimum value) and parameter knob 3 (maximum value).

The settings selected with parameter knobs 2 and 3 determine the value when the control waveform reaches minimum value and maximum value.

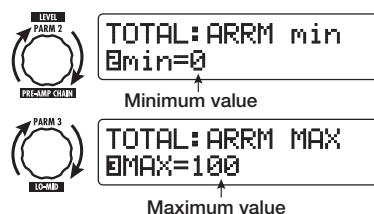

The difference between a parameter setting range of 0 (minimum) – 100 (maximum) and 20 (minimum) – 80 (maximum) is evident from the graph on the next page.

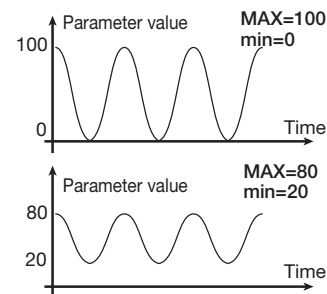

#### HINT

- The available range setting depends on the parameter.
- It is also possible to set "min" to a higher value than "MAX". In that case, the control change direction will be reversed.

### 5. To select the control waveform type and cycle, press the [PAGE] key once to switch the page.



The ARRM function has a total of five parameters. To set parameters 4 and 5, press the [PAGE] key first and then use parameter knobs 1 and 2. (To return to adjusting parameters 1 - 3, press the [PAGE] key once more.)

### 6. Turn parameter knob 1 to select the control waveform.

The display changes as follows.



Available waveforms are shown below.

1		Rising sawtooth (Up Saw)
2		Rising fin (Up Curve)
3		Falling sawtooth (Down Saw)
4		Falling fin (Down Curve)
5		Triangle (Triangle)
6		Square triangle (Square Tri)
7		Sine wave (Sine)
8		Square wave (Square)

### 7. Turn parameter knob 2 to select the control waveform cycle.

When you press the [PAGE] key and then turn parameter knob 2, the display changes as follows.



The control waveform cycle uses the patch specific tempo (→ p. 35) as reference and is displayed as eighth note, quarter note, or quarter note x numeral (see table on page 36).

The numeral after x (2 – 20) indicates the duration of a cycle in multiple quarter notes. When "2" is selected, the control waveform changes in a cycle interval that corresponds to half a note of the patch specific tempo. When "4" is selected, the cycle is 4 beats (1 measure of a 4/4 beat).

### 8. When the ARRM setting is complete, press the [EXIT] key.



The unit returns to play mode. Store the patch as necessary.

When you play your guitar in this condition, the selected effect parameter will be modified cyclically by the internally generated control waveform.

**NOTE**

Any changes in ARRM settings will be lost when you select a new patch. Be sure to store the patch if you want to keep the changes (→ p. 27).

## Using the G7.1ut as audio interface for a computer

By connecting the USB port of the G7.1ut to a USB port on a computer, the G7.1ut can be used as an audio interface with integrated AD/DA converter and effects. The operating environment conditions for this type of use are as follows.

■ **Compatible operating system**

- Windows XP
- Mac OS X (10.2 and later)

■ **Quantization**

16-bit

■ **Sampling frequencies**

32 kHz / 44.1 kHz / 48 kHz

**HINT**

With each of the operating systems listed above, the G7.1ut will function as an audio interface simply by connecting the USB cable. There is no need to install any special driver software.

**NOTE**

The USB port of the G7.1ut only serves for sending and receiving audio data. For MIDI messages, use the MIDI IN/OUT connectors.

To use the G7.1ut as an audio interface for the computer, connect the USB port of the G7.1ut to a USB port on the computer. The G7.1ut will be recognized as an audio interface.

In this condition, the sound of a guitar connected to the INPUT jack of the G7.1ut can be processed with the effects of the G7.1ut and then be recorded on the audio tracks of a DAW (Digital Audio Workstation) software application on the computer (see Figure 1 below).

When performing playback with the DAW application, the playback sound from the audio

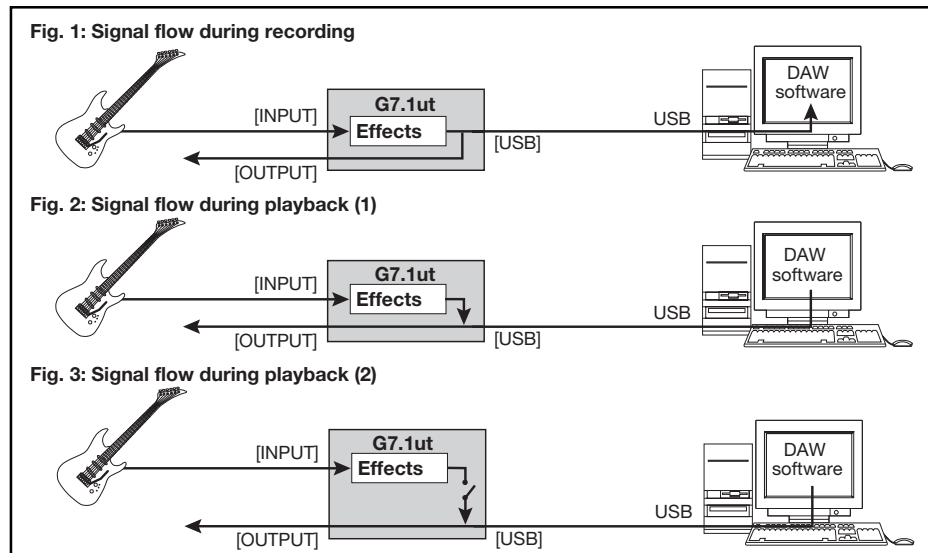

tracks is mixed with the guitar sound processed by the effects of the G7.1ut and appears at the OUTPUT jack of the G7.1ut (see Figure 2 on the previous page).

If required, the guitar signal after effect processing can be muted during playback (see Figure 3 on the previous page). For details, see next section.

For details on recording and playback, refer to the documentation of the DAW application.

**NOTE**

- If the DAW application has an echo back function (input signal during recording is supplied directly to an output), this must be disabled when using the G7.1ut with the direct output enabled. If recording is carried out with the echo back function on, the output signal may sound as if processed by a flanger effect, or the direct output signal may sound delayed.
- Use a high-quality USB cable and keep the connection as short as possible.

## Muting the direct output when using a USB connection

When the G7.1ut is connected to a computer and used as an audio interface, the signal appearing at the OUTPUT jack after effect processing may be muted if you want to monitor the sound from the DAW software only. To do this, proceed as follows.

**HINT**

The following procedure is only valid when the G7.1ut is connected to a computer via USB.

**1. In play mode, press the [AMP SELECT/SYSTEM] key.**

The AMP SELECT/SYSTEM menu for parameters that apply to all patches appears.



**2. Turn the [TYPE] knob to bring up the indication “USB Monitor” (output mode when USB connection is used) on the display.**

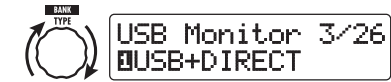

**3. Turn parameter knob 1 to select one of the following settings.**

● **USB+DIRECT**

The signal after effect processing appears at the OUTPUT jack also when USB connection is used.

● **USB Only**

The signal after effect processing at the OUTPUT jack is muted when USB connection is used.

**4. When the setting is complete, press the [EXIT] key.**

The indication “Store...?” appears on the display, to allow you to store the changes.



**5. Press the [STORE/SWAP] key to save the changes.**



In the above condition (while “Store...?” is shown), only the [STORE/SWAP] key, [EXIT] key, and [PAGE] key are active. By pressing the [EXIT] key, you can abort the changes and return to play mode without saving.

## About the editor/librarian software

ZOOM CORPORATION makes an editor/librarian software application available for download on its web site.

To use the software, the computer must have a MIDI interface, and a connection must be established between the MIDI IN/MIDI OUT connectors of the computer and the MIDI OUT/MIDI IN connectors of the G7.1ut. The software then makes it possible to store patch data of the G7.1ut on the computer, edit the data, and copy edited patch data back to the G7.1ut.

- Web site of ZOOM CORPORATION  
<http://www.zoom.co.jp>

## Adjusting the display contrast

If required, you can adjust the display contrast as follows.

1. In play mode, press the [AMP SELECT/SYSTEM] key.

The AMP SELECT/SYSTEM menu for parameters that apply to all patches appears.



2. Turn the [TYPE] knob to bring up the indication "Contrast" (display contrast) on the display.

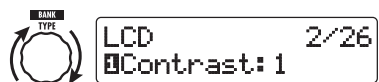

3. Turn parameter knob 1 to adjust the contrast in the range from 1 – 3.

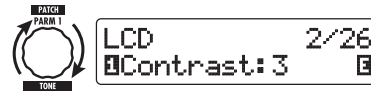

4. When the setting is complete, press the [EXIT] key to exit the AMP SELECT/SYSTEM menu.

The indication "Store...?" appears on the display, to allow you to store the changes.



5. Press the [STORE/SWAP] key to save the changes.



The contrast setting is accepted, and the unit returns to play mode.

In the above condition (while "Store...?" is shown), only the [STORE/SWAP] key, [EXIT] key, and [PAGE] key are active. By pressing the [EXIT] key, you can abort the changes and return to play mode without saving.

## Linking Effects

The patches of the G7.1ut can be thought of as nine serially linked effect modules, as shown in the illustration below. You can use all effect modules together or selectively set certain modules to off to use just specific effect modules.

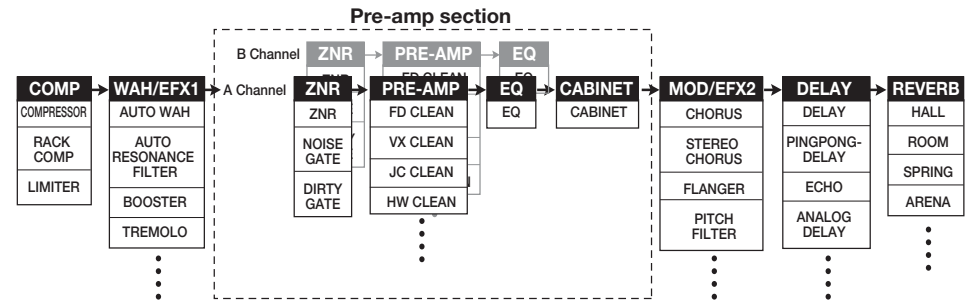

For some effect modules, you can select an effect type from several possible choices. For example, the MOD/EFX2 module comprises CHORUS, FLANGER, and other effect types from which you can choose one.

The four-module series ZNR, PRE-AMP, EQ, and CABINET functions as a virtual preamplifier with two channels. The ZNR, PRE-AMP, and EQ modules can have different settings for channels A and B, allowing channel switching also within the same patch.

the PRE-AMP module. This algorithm optimizes the sound for playing through a guitar amp. When the G7.1ut is connected to a guitar amp, this setting is recommended.

- When CABINET module is on

The direct recording algorithm is selected for the PRE-AMP module. This algorithm optimizes the sound for reproduction via a system with flat response. When the G7.1ut is connected to a recorder or hi-fi audio system, this setting is recommended.

## Switching between live performance sound and direct recording sound

The PRE-AMP module of the G7.1ut comprises a total of 36 effect types. In addition, each of these effect types has two algorithms, one for live playing and one for direct recording. This amounts to having access to 72 effect types.

The respective algorithm is selected automatically, depending on the status of the CABINET module, as described below.

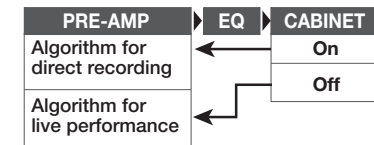

### NOTE

When the CABINET module is off, the AMP SELECT function for matching the G7.1ut to the amplifier in use is also available. For details, see the next page.

- When CABINET module is off

The live performance algorithm is selected for

## Using the Amp Select Function

The G7.1ut incorporates an Amp Select function that optimizes the frequency response to match a the type of amplifier in use. When starting to use the G7.1ut or when changing the guitar amp, you should choose a suitable Amp Select setting as described below.

### NOTE

The Amp Select feature is disabled for patches where the CABINET module is set to on. This is because the PRE-AMP module algorithm for direct recording will be automatically selected when the CABINET module is on.

1. In play mode, press the [AMP SELECT/SYSTEM] key.



2. Turn parameter knob 1 to select one of the following settings.

### ● FRONT

This is the standard setting for using the GUITAR INPUT on the front of the guitar amp.

### ● COMBO R1

This setting is suitable when using the POWER INPUT on the rear panel of a Roland JC-120 guitar amp.

### ● COMBO R2

This setting is suitable when using the POWER INPUT on the rear panel of a Fender combo amp.

### ● STACK R

This setting is suitable when using the POWER INPUT on the rear panel of a Marshall stack amp.

3. When the setting is complete, press the [EXIT] key.

The indication "Store...?" appears on the display, to allow you to store the changes.

4. Press the [STORE/SWAP] key to save the changes.

In the above condition (while "Store...?" is shown), only the [STORE/SWAP], [EXIT], and [PAGE] keys are active. By pressing the [EXIT] key, you can abort the changes and return to play mode without saving.

## Changing the insert position of the pre-amp section and WAH/EFX1 module

The G7.1ut allows you to change the insert position of the four modules making up the pre-amp section (ZNR, PRE-AMP, EQ, CABINET) and the WAH/EFX1 module. This will result in changes to the effect action and tone.

### ■ Changing the insert position of the WAH/EFX1 module

To change the insert position of the WAH/EFX1 module, call up the Position parameter and set it to "Befr" (before pre-amp section) or "Afr" (after pre-amp section). The Position parameter can be used when the Booster, Tremolo, or Octave effect type is not selected.

1. In play mode, manual mode, or edit mode, press the [WAH/EFX1] key.

2. Turn the [TYPE] knob and select an effect type other than Booster, Tremolo, or Octave.

3. Turn parameter knob 1 to select "Befr" (before pre-amp section) or "Afr" (after pre-amp section).

4. When the setting is complete, press the [EXIT] key.

The unit returns to the previous mode. To enable the changed setting, be sure to store the patch (→ p. 27).

### ■ Changing the insert position of the pre-amp section

To change the insert position of the pre-amp section, call up the Chain parameter and set it to "Pre" (before MOD/EFX2 module) or "Post" (after DELAY module). The Chain parameter can be used with all effect types of the PRE-AMP module.

1. In play mode, manual mode, or edit mode, press the [PRE-AMP] key.

The display changes as follows.

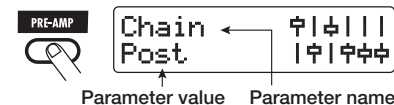

Fig. 1 Pre-amp section = PRE, WAH/EFX1 = Befr



Fig. 2 Pre-amp section = PRE, WAH/EFX1 = Afr



Fig. 3 Pre-amp section = POST, WAH/EFX1 = Befr

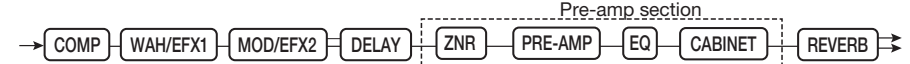
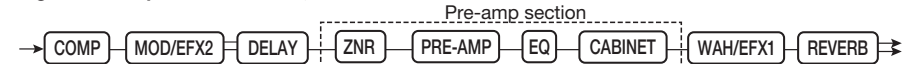

Fig. 4 Pre-amp section = POST, WAH/EFX1 = Afr



# Effect Types and Parameters

## How to read the parameter table

**Effect parameters 1 – 4**  
 When this effect type is selected, the four parameters listed here can be adjusted with parameter knobs 1 - 4. The setting range for each parameter is also shown. Some effect parameters are adjusted with the knobs of the pre-amp section.

Effect module  
 Effect type

**Tempo sync**  
 The note symbol (♪) in the table indicates that the parameter can be synchronized to the patch specific tempo. If you select the note symbol as value for the parameter when making the setting at the G7.1ut, the parameter value will be synchronized to the patch specific tempo in note units (→ p. 35).

**Expression pedal**  
 The pedal symbol (👣) in the table indicates that the parameter can be controlled with the built-in expression pedal. If you select the parameter as control target when making the setting at the G7.1ut (→ p. 30), the expression pedal will adjust the parameter in real time when the patch is selected. Parameters with the pedal symbol can also be selected as control targets for the ARRM function.

**Delay tap/hold delay/delay mute**  
 The tap (**TAP**), hold (**HOLD**), and mute (**MUTE**) symbols in the table indicate that the respective foot switch can be used to specify the delay time (TAP), toggle hold delay on and off (HOLD), or toggle mute between on and off (MUTE). This applies only to the DELAY module.

To use these functions, the respective function must be assigned to the foot switch (→ p. 34) and the respective effect type must be enabled.

### COMP module

Attenuates high-level signal components and boosts low-level signal components, to keep the overall signal level within a certain range.

Compressor							
This is an MXR Dynacomp type compressor.							
PARM1		PARM2		PARM3		PARM4	
<b>Sense</b>	0 – 10	<b>Attack</b>	Fast, Slow	<b>Tone</b>	0 – 10	<b>Level</b>	2 – 100
Adjusts the compressor sensitivity. Higher setting values result in higher sensitivity.		Selects compressor attack speed in two levels: Fast or Slow.		Adjusts the tonal quality of the sound.		Adjusts the signal level after passing the module.	

RackComp							
This effect type allows more detailed adjustment than "Compressor".							
PARM1		PARM2		PARM3		PARM4	
<b>Threshold</b>	0 – 50	<b>Ratio</b>	1 – 10	<b>Attack</b>	1 – 10	<b>Level</b>	2 – 100
Adjusts the reference signal level for the compressor action.		Adjusts the compression ratio.		Adjusts the compressor attack speed.		Adjusts the signal level after passing the module.	

Limiter							
This is a limiter that suppresses signal peaks above a certain reference level.							
PARM1		PARM2		PARM3		PARM4	
<b>Threshold</b>	0 – 50	<b>Ratio</b>	1 – 10	<b>Release</b>	1 – 10	<b>Level</b>	2 – 100
Adjusts the reference signal level for the limiter action.		Adjusts the compression ratio of the limiter.		Adjusts the delay between the point where the signal level falls below the threshold level and the limiter release.		Adjusts the signal level after passing the module.	

### WAH/EFX1 module

This module comprises wah and filter effects as well as special effects such as ring modulator and octave.

**AutoWah**  
 This effect varies wah in accordance with picking intensity.

**A-Resonance**  
 This effect varies the resonance filter frequency in accordance with picking intensity.  
 The above two effect types have the same parameters.

PARM1		PARM2		PARM3		PARM4	
<b>Position</b>	Befr, Afr	<b>Sense</b>	-10 – -1, 1 – 10	<b>Resonance</b>	0 – 10	<b>Level</b>	2 – 100
Selects the connection position of the WAH/EFX1 module. Available settings are "Befr" (before pre-amp section) or "Afr" (after pre-amp section).		Adjusts the effect sensitivity.		Adjusts the intensity of the resonance sound.		Adjusts the signal level after passing the module.	

Booster							
This is a booster for increasing signal gain.							
PARM1		PARM2		PARM3		PARM4	
<b>Range</b>	1 – 5	<b>Tone</b>	0 – 10	<b>Gain</b>	0 – 10	<b>Level</b>	2 – 100
Adjusts the frequency range to boost		Adjusts the tonal quality of the sound.		Adjusts the amount of boost.		Adjusts the signal level after passing the module.	



<b>Tremolo</b>			
This effect periodically varies the volume level.			
PARAM1	PARAM2		PARAM3
<b>Depth</b>	0 – 100	<b>Rate</b>	0 – 50
Adjusts the modulation depth.		Adjusts the modulation rate.	
		Controls the modulation waveform. Available waveform types are "UP" (rising sawtooth), "DWN" (falling sawtooth), and "TRI" (triangular). Higher numerical values result in stronger clipping, which emphasizes the effect.	
		<b>Level</b>	
		2 – 100	
Adjusts the signal level after passing the module.			

<b>Phaser</b>			
This effect produces a swooshing sound.			
PARAM1	PARAM2		PARAM3
<b>Position</b>	Befr, Afr	<b>Rate</b>	0 – 50
Selects the connection position of the WAH/EFX1 module. Available settings are "Befr" (before pre-amp section) or "Afr" (after pre-amp section).		Adjusts the modulation rate.	
		Adjusts the sound color.	
		<b>Level</b>	
		2 – 100	
Adjusts the signal level after passing the module.			

<b>Ring Modulate</b>			
This effect produces a metallic ringing sound. Adjusting the "Freq" parameter results in a drastic change of sound character.			
PARAM1	PARAM2		PARAM3
<b>Position</b>	Befr, Afr	<b>Frequency</b>	1 – 50
Selects the connection position of the WAH/EFX1 module. Available settings are "Befr" (before pre-amp section) or "Afr" (after pre-amp section).		Adjusts the modulation frequency.	
		Adjusts the balance between original sound and effect sound.	
		<b>Level</b>	
		2 – 100	
Adjusts the signal level after passing the module.			

<b>Slow Attack</b>			
This effect slows down the attack rate of the sound, resulting in a violin playing style sound.			
PARAM1	PARAM2		PARAM3
<b>Position</b>	Befr, Afr	<b>Time</b>	1 – 50
Selects the connection position of the WAH/EFX1 module. Available settings are "Befr" (before pre-amp section) or "Afr" (after pre-amp section).		Adjusts the rise time.	
		Adjusts the rising volume change curve.	
		<b>Level</b>	
		2 – 100	
Adjusts the signal level after passing the module.			

**Pedal Vox**  
Simulation of the vintage Vox pedal wah.

**Pedal Cry**  
Simulation of the vintage Crybaby pedal wah.

The above two effect types have the same parameters.

PARAM1	PARAM2		PARAM3		PARAM4
<b>Position</b>	Befr, Afr	<b>Frequency</b>	1 – 50	<b>Dry Mix</b>	0 – 10
Selects the connection position of the WAH/EFX1 module. Available settings are "Befr" (before pre-amp section) or "Afr" (after pre-amp section).		Adjusts the frequency that is emphasized. When the expression pedal is not used, the effect is similar to a half open pedal.		Adjusts the level of the original sound mixed to the effect sound.	
				2 – 100	
Adjusts the signal level after passing the module.					

<b>P-Resonance</b>			
Pedal wah with a strong character.			
PARAM1	PARAM2		PARAM3
<b>Position</b>	Befr, Afr	<b>Frequency</b>	1 – 50
Selects the connection position of the WAH/EFX1 module. Available settings are "Befr" (before pre-amp section) or "Afr" (after pre-amp section).		Adjusts the modulation frequency.	
		Adjusts the resonance intensity.	
		<b>Level</b>	
		2 – 100	
Adjusts the signal level after passing the module.			

<b>Octave</b>			
This effect adds a one-octave lower component to the original sound.			
PARAM1	PARAM2		PARAM3
<b>OctLevel</b>	0 – 100	<b>DryLevel</b>	0 – 100
Adjusts the level of the one-octave lower sound component.		Adjusts the level of the original sound.	
		Adjusts the tonal quality of the sound.	
		<b>Level</b>	
		2 – 100	
Adjusts the signal level after passing the module.			

		<b>ZNR module</b>
		This module serves for reducing noise during playing pauses. It offers a choice between noise reduction and noise gate (muting during pauses).
<b>ZNR (ZOOM NOISE REDUCTION)</b>		
ZOOM original noise reduction which reduces noise in playing pauses without affecting the overall tone.		













**Noise Gate**  
This is a noise gate which cuts off the sound during playing pauses.

**Dirty Gate**  
This is a vintage type gate with special closing characteristics.



The above three effect types have the same parameter.



PARAM1	
<b>Threshold</b>	1 – 16
Adjusts the ZNR sensitivity. For maximum noise reduction, set the value as high as possible without causing the sound to decay unnaturally.	

<b>PRE AMP module</b>	
	This module comprises 35 types of distortion and an acoustic simulator. In edit mode, the module is adjusted using the [GAIN] and [LEVEL] knobs of the pre-amp section and the parameter knobs 1 and 2. For each effect type in this module, there are 2 algorithms (for live playing and direct recording). The algorithms are automatically selected according to the on/off status of the CABINET module (→ p. 51).
<b>FD Clean</b> Clean sound of a Fender Twin Reverb ('65 model) favored by guitarists of many music styles.	<b>VX Clean</b> Clean sound of the combo amp VOX AC-30 operating in class A.
<b>JC Clean</b> Clean sound of the Roland JC series which gives a wide, clear tone.	<b>HW Clean</b> Clean sound of the legendary all-tube Hiwatt Custom 100 from Britain.
<b>MS Crunch</b> Crunch sound of a Marshall stack amp JCM800 that varies from clean to crunch.	<b>UK Blues</b> Crunch sound of the 30-watt combo amp Marshall 1962 Bluesbreaker.
<b>US Blues</b> Crunch sound of a Fender Tweed Deluxe '53.	<b>Tweed Bass</b> Crunch sound of the Fender Bassman, a bass amp with a strong presence.
<b>BG Crunch</b> Crunch sound of the Mesa Boogie MkIII combo amp.	<b>VX Crunch</b> Crunch sound of class A combo amp Vox AC30TBX.
<b>Z Combo</b> Zoom original combo amp crunch sound.	<b>MS Drive</b> High gain sound of the Marshall stack amp JCM2000.
<b>BG Drive</b> High gain sound of the Mesa Boogie Dual Rectifier channel 2 (vintage mode).	<b>PV Drive</b> High gain sound of a Peavey 5150 developed in cooperation with a world-famous hard rock guitarist.
<b>HK Drive</b> High gain sound of the Hughes & Kettner flagship model Triamp MKII.	<b>DZ Drive</b> High gain sound of the hand-made German guitar amp Diezel Herbert with three separately controllable channels.
<b>Z Stack</b> Zoom original head amp high gain sound.	<b>OverDrive</b> Simulation of the Boss OD-1 that first created the "overdrive" concept.
<b>TS808</b> Simulation of the often copied Ibanez TS808 used by many guitarists as a booster.	<b>Centaur</b> Simulation of the KLON Centaur favored by many pros.
<b>Guv'nor</b> Simulation of the Guv'nor distortion effect from Marshall.	<b>RAT</b> Simulation of the PROCO Rat famous for its edgy distortion sound.
<b>DS-1</b> Simulation of the Boss distortion DS-1, a long-time favorite.	<b>dist +</b> Simulation of MXR distortion+ that made distortion popular worldwide.
<b>HotBox</b> Simulation of the compact Matchless HotBox preamp with built-in tubes.	<b>FuzzFace</b> Simulation of the Fuzz Face that made rock history with its zany look and smashing sound.
<b>BigMuff</b> Simulation of the Electro-Harmonix Big Muff preferred by famous artists for its fat, sweet fuzz sound.	<b>MetalZone</b> Simulation of the Boss Metal Zone with long sustain and dynamic lower mid range.





<b>TS+F_Cmb</b> Combination of Fender combo amp and Ibanez TS-9 sound.	<b>SD+M_Stk</b> Combination of Marshall stack amp and Boss SD-1 sound.																																																
<b>FZ+M_Stk</b> Combination of Fuzz Face and Marshall stack amp sound.	<b>Z OD</b> Zoom original overdrive with natural distortion.																																																
<b>Extreme DS</b> High gain sound with the highest gain of any distortion effect in the world.	<b>DigiFuzz</b> High gain fuzz sound with strong character.																																																
<b>Z Clean</b> Zoom original straightforward clean sound. The above 35 effect types have the same parameters.																																																	
<table border="1"> <thead> <tr> <th colspan="2">GAIN</th> <th colspan="2">LEVEL</th> </tr> </thead> <tbody> <tr> <td> <b>Gain</b></td> <td>0 – 100</td> <td> <b>Level</b></td> <td>1 – 100</td> </tr> <tr> <td colspan="2">Adjusts the preamp gain (distortion depth).</td> <td colspan="2">Adjusts the signal level after passing the module.</td> </tr> <tr> <th colspan="2">PARAM1</th> <th colspan="2">PARAM2</th> </tr> <tr> <td><b>Tone</b></td> <td>0 – 30</td> <td><b>Chain</b></td> <td>Pre, Post</td> </tr> <tr> <td colspan="2">Adjusts the tonal quality of the sound.</td> <td colspan="2">Selects the connection position of the pre-amp section. Available settings are "Pre" (before MOD/EFX2 module) or "Post" (after DELAY module).</td> </tr> </tbody> </table>		GAIN		LEVEL		 <b>Gain</b>	0 – 100	 <b>Level</b>	1 – 100	Adjusts the preamp gain (distortion depth).		Adjusts the signal level after passing the module.		PARAM1		PARAM2		<b>Tone</b>	0 – 30	<b>Chain</b>	Pre, Post	Adjusts the tonal quality of the sound.		Selects the connection position of the pre-amp section. Available settings are "Pre" (before MOD/EFX2 module) or "Post" (after DELAY module).																									
GAIN		LEVEL																																															
 <b>Gain</b>	0 – 100	 <b>Level</b>	1 – 100																																														
Adjusts the preamp gain (distortion depth).		Adjusts the signal level after passing the module.																																															
PARAM1		PARAM2																																															
<b>Tone</b>	0 – 30	<b>Chain</b>	Pre, Post																																														
Adjusts the tonal quality of the sound.		Selects the connection position of the pre-amp section. Available settings are "Pre" (before MOD/EFX2 module) or "Post" (after DELAY module).																																															
<b>Aco. Sim</b> This effect makes an electric guitar sound like an acoustic guitar.																																																	
<table border="1"> <thead> <tr> <th colspan="2">GAIN</th> <th colspan="2">LEVEL</th> </tr> </thead> <tbody> <tr> <td> <b>Top</b></td> <td>0 – 10</td> <td> <b>Level</b></td> <td>1 – 100</td> </tr> <tr> <td colspan="2">Adjusts the characteristic strings sound of an acoustic guitar.</td> <td colspan="2">Adjusts the signal level after passing the module.</td> </tr> <tr> <th colspan="2">PARAM1</th> <th colspan="2">PARAM2</th> </tr> <tr> <td><b>Body</b></td> <td>0 – 10</td> <td><b>Chain</b></td> <td>Pre, Post</td> </tr> <tr> <td colspan="2">Adjusts the characteristic body sound of an acoustic guitar.</td> <td colspan="2">Selects the connection position of the pre-amp section. Available settings are "Pre" (before MOD/EFX2 module) or "Post" (after DELAY module).</td> </tr> </tbody> </table>		GAIN		LEVEL		 <b>Top</b>	0 – 10	 <b>Level</b>	1 – 100	Adjusts the characteristic strings sound of an acoustic guitar.		Adjusts the signal level after passing the module.		PARAM1		PARAM2		<b>Body</b>	0 – 10	<b>Chain</b>	Pre, Post	Adjusts the characteristic body sound of an acoustic guitar.		Selects the connection position of the pre-amp section. Available settings are "Pre" (before MOD/EFX2 module) or "Post" (after DELAY module).																									
GAIN		LEVEL																																															
 <b>Top</b>	0 – 10	 <b>Level</b>	1 – 100																																														
Adjusts the characteristic strings sound of an acoustic guitar.		Adjusts the signal level after passing the module.																																															
PARAM1		PARAM2																																															
<b>Body</b>	0 – 10	<b>Chain</b>	Pre, Post																																														
Adjusts the characteristic body sound of an acoustic guitar.		Selects the connection position of the pre-amp section. Available settings are "Pre" (before MOD/EFX2 module) or "Post" (after DELAY module).																																															
	<b>EQ module</b> This is a 6-band equalizer. In edit mode, the module is adjusted using the [BASS], [MIDDLE], [TREBLE], and [PRESENCE] knobs of the pre-amp section and the parameter knobs 3 and 4.																																																
<table border="1"> <thead> <tr> <th colspan="2">BASS</th> <th colspan="2">MIDDLE</th> <th colspan="2">TREBLE</th> <th colspan="2">PRESENCE</th> </tr> </thead> <tbody> <tr> <td><b>Bass</b></td> <td>±12 160Hz</td> <td><b>Middle</b></td> <td>±12 800Hz</td> <td><b>Treble</b></td> <td>±12 3.2kHz</td> <td><b>Presence</b></td> <td>±12 6.4kHz</td> </tr> <tr> <td colspan="2">Adjusts boost/cut in the low frequency range.</td> <td colspan="2">Adjusts boost/cut in the middle frequency range.</td> <td colspan="2">Adjusts boost/cut in the high frequency range.</td> <td colspan="2">Adjusts boost/cut in the very high frequency range.</td> </tr> <tr> <th colspan="4">PARAM3</th> <th colspan="4">PARAM4</th> </tr> <tr> <td colspan="2"><b>Low-Mid</b></td> <td colspan="2">±12 400Hz</td> <td colspan="2"><b>Harmonics</b></td> <td colspan="2">±12 12kHz</td> </tr> <tr> <td colspan="4">Adjusts boost/cut in the lower-middle frequency range.</td> <td colspan="4">Adjusts boost/cut in the harmonics frequency range.</td> </tr> </tbody> </table>		BASS		MIDDLE		TREBLE		PRESENCE		<b>Bass</b>	±12 160Hz	<b>Middle</b>	±12 800Hz	<b>Treble</b>	±12 3.2kHz	<b>Presence</b>	±12 6.4kHz	Adjusts boost/cut in the low frequency range.		Adjusts boost/cut in the middle frequency range.		Adjusts boost/cut in the high frequency range.		Adjusts boost/cut in the very high frequency range.		PARAM3				PARAM4				<b>Low-Mid</b>		±12 400Hz		<b>Harmonics</b>		±12 12kHz		Adjusts boost/cut in the lower-middle frequency range.				Adjusts boost/cut in the harmonics frequency range.			
BASS		MIDDLE		TREBLE		PRESENCE																																											
<b>Bass</b>	±12 160Hz	<b>Middle</b>	±12 800Hz	<b>Treble</b>	±12 3.2kHz	<b>Presence</b>	±12 6.4kHz																																										
Adjusts boost/cut in the low frequency range.		Adjusts boost/cut in the middle frequency range.		Adjusts boost/cut in the high frequency range.		Adjusts boost/cut in the very high frequency range.																																											
PARAM3				PARAM4																																													
<b>Low-Mid</b>		±12 400Hz		<b>Harmonics</b>		±12 12kHz																																											
Adjusts boost/cut in the lower-middle frequency range.				Adjusts boost/cut in the harmonics frequency range.																																													

<b>CABINET module</b>			
 <p>This effect simulates the sound obtained when recording an amp cabinet with a microphone. The simulated mic type and position can be selected. The on/off status of this module controls the automatic algorithm selection in the PRE-AMP module (→ p. 51).</p>			
PARAM1		PARAM2	
<b>Mic Type</b>	Dyna, Cond	<b>Mic Posi</b>	0 – 2
Selects the microphone type. "Dyna" simulates the frequency response of a dynamic mic and "Cond" that of a condenser mic.		Lets you select different characteristics according to the mic position. The following settings are available. 0: Mic pointed at speaker center 1: Mic pointed halfway between speaker edge and center 2: Mic pointed at speaker edge	
		PARAM3	
		<b>Depth</b>	0 – 2
		Adjusts the effect depth	

<b>MOD/EFX2 module</b>			
 <p>This module comprises modulation effects such as chorus and flanger, delay effects, and pitch shifter effects.</p>			
<b>Chorus</b>			
This effect mixes a variable pitch-shifted component to the original signal, resulting in full-bodied resonating sound.			
PARAM1		PARAM2	
<b>Depth</b>	0 – 100	 <b>Rate</b>	1 – 50
Adjusts the effect depth.		<b>Tone</b>	0 – 10
		PARAM4	
		 <b>Mix</b>	0 – 100
		Adjusts the level of the effect sound mixed to the original sound.	

<b>ST-Chorus</b>			
This is a clear sounding stereo chorus.			
PARAM1		PARAM2	
 <b>Depth</b>	0 – 100	 <b>Rate</b>	1 – 50
Adjusts the effect depth.		<b>Tone</b>	0 – 10
		PARAM4	
		 <b>Mix</b>	0 – 100
		Adjusts the level of the effect sound mixed to the original sound.	





<b>Ensemble</b>			
This is a chorus ensemble with three-dimensional movement.			
PARAM1		PARAM2	
<b>Depth</b>	0 – 100	<b>Rate</b>	1 – 50
Adjusts the effect depth.		<b>Tone</b>	0 – 10
		PARAM4	
		 <b>Mix</b>	0 – 100
		Adjusts the level of the effect sound mixed to the original sound.	





<b>Flanger</b>			
This effect produces a resonating and strongly undulating sound.			
PARAM1		PARAM2	
 <b>Depth</b>	0 – 100	 <b>Rate</b>	0 – 50 
Adjusts the effect depth.		 <b>Resonance</b>	-10 – -1, 0, 1 – 10
		PARAM4	
		 <b>Manual</b>	0 – 100
		Adjusts the frequency range on which the effect operates.	





<b>Pitch Shift</b>			
This effect shifts the pitch up or down.			
PARAM1		PARAM2	
<b>Shift</b>	-12 – -1, 0, 1 – 12, 24	<b>Tone</b>	0 – 10
Sets the pitch shift amount in semitones.		Adjusts the tonal quality of the sound.	
		PARAM3	
		<b>Fine</b>	-25 – 25
		Allows fine adjustment of pitch shift amount in Cent (1/100 semitone) steps.	
PARAM4			
		 <b>Balance</b>	0 – 100
		Adjusts the balance between original sound and effect sound.	

<b>Pedal Pitch</b>			
This effect allows using a pedal to shift the pitch in real time.			
PARAM1		PARAM2	
<b>Color</b>	1 – 8	<b>Mode</b>	Up, Down
Selects the type of pitch change caused by the pedal (see Table 1).		Sets the direction of the pitch change to Up or Down.	
		PARAM3	
		<b>Tone</b>	0 – 10
		Adjusts the tonal quality of the sound.	
PARAM4			
		 <b>PdlPosi</b>	0 – 100
		Sets the pitch shift amount. Depending on the "Color" setting, the balance between original sound and effect sound also changes accordingly.	

[Table 1]

Color	Mode	 Pedal minimum value	 Pedal maximum value	Color	Mode	 Pedal minimum value	 Pedal maximum value
1	Up Down	-100 cent Original sound only	Original sound only -100 cent	5	Up Down	-1 octave + DRY +1 octave + DRY	+1 octave + DRY -1 octave + DRY
2	Up Down	DOUBLING Detune + DRY	Detune + DRY DOUBLING	6	Up Down	-700 cent + DRY +500 cent + DRY	+500 cent + DRY -700 cent + DRY
3	Up Down	0 cent +1 octave	+1 octave 0 cent	7	Up Down	-∞ (0 Hz) + DRY +1 octave	+1 octave -∞ (0 Hz) + DRY
4	Up Down	0 cent -2 octaves	-2 octaves 0 cent	8	Up Down	-∞ (0 Hz) + DRY +1 octave + DRY	+1 octave + DRY -∞ (0 Hz) + DRY

<b>Vibe</b>			
This is an effect with automatic vibrato.			
PARAM1		PARAM2	
 <b>Depth</b>	0 – 100	 <b>Rate</b>	0 – 50 
Adjusts the effect depth.		<b>Tone</b>	0 – 10
		PARAM4	
		 <b>Balance</b>	0 – 100
		Adjusts the balance between original sound and effect sound.	

<b>Step</b>			
Special effect that changes the sound in a staircase pattern.			
PARAM1		PARAM2	
 <b>Depth</b>	0 – 100	 <b>Rate</b>	0 – 50 
Adjusts the modulation depth.		 <b>Resonance</b>	0 – 10
		PARAM4	
		 <b>Shape</b>	0 – 10
		Adjusts the effect sound envelope.	

Delay	
This is a delay with a maximum setting of 2000 ms.	

Tape Echo	
This effect simulates a tape echo.	

The above two effect types have the same parameters.

PARAM1		PARAM2		PARAM3		PARAM4	
<b>Time</b>	1 – 2000 mS	<b>FeedBack</b>	0 – 100	<b>HiDamp</b>	0 – 10	<b>Mix</b>	0 – 100
Sets the delay time.		Adjusts the amount of feedback. Higher setting values result in a higher number of delay sound repetitions.		Adjusts the treble attenuation of the delay sound. Lower setting values result in softer delay sound.		Adjusts the level of the effect sound mixed to the original sound.	

Dynamic Delay	
This is a dynamic delay where the effect volume varies according to the input signal level.	

PARAM1		PARAM2		PARAM3		PARAM4	
<b>Time</b>	1 – 2000 mS	<b>Amount</b>	0 – 100	<b>FeedBack</b>	0 – 100	<b>Sense</b>	-10 – -1, 1 – 10
Sets the delay time.		Adjusts the level of the effect sound mixed to the original sound.		Adjusts the amount of feedback.		Adjusts the effect sensitivity. With positive setting values, the effect sound level increases at higher input signal levels. With negative setting values, the effect sound level decreases at higher input signal levels.	

Dynamic Flang	
This is a dynamic flanger where the effect volume varies according to the input signal level.	

PARAM1		PARAM2		PARAM3		PARAM4	
<b>Depth</b>	0 – 100	<b>Rate</b>	0 – 50	<b>Resonance</b>	-10 – -1, 0, 1 – 10	<b>Sense</b>	-10 – -1, 1 – 10
Adjusts the modulation depth.		Adjusts the modulation rate.		Adjusts the resonance intensity.		Adjusts the effect sensitivity. With positive setting values, the effect sound level increases at higher input signal levels. With negative setting values, the effect sound level decreases at higher input signal levels.	

Mono Pitch	
This is a pitch shifter specifically for monophonic sound (single-note playing), with little sound fluctuation.	

PARAM1		PARAM2		PARAM3		PARAM4	
<b>Shift</b>	-24 – +24	<b>Tone</b>	0 – 10	<b>Fine</b>	-25 – 25	<b>Balance</b>	0 – 100
Adjusts the pitch shift amount in semitones.		Adjusts the tonal quality of the sound.		Allows fine adjustment of pitch shift amount in Cent (1/100 semitone) steps.		Adjusts the balance between original sound and effect sound.	

H.P.S (Harmonized Pitch Shifter)					
This is an intelligent pitch shifter that automatically generates harmonies according to a preset key and scale.					

PARAM1		PARAM2		PARAM3		PARAM4	
<b>Scale</b>	-6, -5, -4, -3, -m, m, 3, 4, 5, 6	<b>Key</b>	C, C#, D, D#, E, F, F#, G, G#, A, A#, B	<b>Tone</b>	0 – 10	<b>Mix</b>	0 – 100
Determines the interval for the pitch shifted sound (see Table 2).		Determines the tonic for the scale used for pitch shifting.		Adjusts the tonal quality of the sound.		Adjusts the level of the effect sound mixed to the original sound.	

[Table2]

Setting	Type of scale	Interval	Setting	Type of scale	Interval
-6	Major scale	Sixth down	3	Major scale	Third up
-5		Fifth down	4		Fourth up
-4		Fourth down	5		Fifth up
-3		Third down	6		Sixth up
-m	Minor scale	Third down			
m		Third up			

Pdl Mono Pitch	
This is a pitch shifter specifically for monophonic sound (single-note playing), which allows the pitch to be shifted in real time with the expression pedal.	

PARAM1		PARAM2		PARAM3		PARAM4	
<b>Color</b>	1 – 8	<b>Mode</b>	Up, Down	<b>Tone</b>	0 – 10	<b>PdlPosi</b>	0 – 100
Selects the type of pitch change caused by the pedal (see Table 1).		Sets the direction of the pitch change to Up or Down.		Adjusts the tonal quality of the sound.		Sets the pitch shift amount. Depending on the "Color" setting, the balance between original sound and effect sound also changes accordingly.	

Cry	
This effect varies the sound like a talking modulator.	

PARAM1		PARAM2		PARAM3		PARAM4	
<b>Range</b>	1 – 10	<b>Resonance</b>	0 – 10	<b>Sense</b>	-10 – -1, 1 – 10	<b>Balance</b>	0 – 100
Adjusts the frequency range processed by the effect.		Adjusts the resonance intensity.		Adjusts the effect sensitivity.		Adjusts the balance between original sound and effect sound.	

Reverse Delay	
This is a special delay where the effect sounds as if playing in reverse.	

PARAM1		PARAM2		PARAM3		PARAM4	
<b>Time</b>	10 – 1000	<b>FeedBack</b>	0 – 100	<b>HiDamp</b>	0 – 10	<b>Balance</b>	0 – 100
Sets the delay time.		Adjusts the amount of feedback.		Adjusts the treble attenuation of the delay sound.		Adjusts the balance between original sound and effect sound.	

Bend Chorus	
This effect provides pitch bending that uses the input signal as trigger and processes each note separately.	

PARAM1		PARAM2		PARAM3		PARAM4	
<b>Depth</b>	-50 – 50	<b>Attack</b>	1 – 10	<b>Release</b>	1 – 10	<b>Balance</b>	0 – 100
Adjusts the effect depth.		Adjusts the attack time for the bending effect. Higher setting values result in slower attack.		Adjusts the release time for the bending effect. Higher setting values result in slower release.		Adjusts the balance between original sound and effect sound.	

Comb Filter			
This effect uses the comb filter characteristics generated by using fixed modulation on the flanger as an equalizer.			
PARAM1	PARAM2	PARAM3	PARAM4
<b>Frequency</b>   1 – 50	<b>Resonance</b>   -10 – 10	<b>HiDamp</b>   0 – 10	<b>Mix</b>   0 – 100
Adjusts the frequency to be emphasized.	Adjusts the resonance intensity.	Adjusts the treble attenuation of the effect sound.	Adjusts the level of the effect sound mixed to the original sound.

Air			
This effect reproduces the ambience of a room, to create spatial depth.			
PARAM1	PARAM2	PARAM3	PARAM4
<b>Size</b>   1 – 100	<b>Reflex</b>   0 – 10	<b>Tone</b>   0 – 10	<b>Mix</b>   0 – 100
Adjusts the size of the simulated space.	Adjusts the amount of reflections from the wall.	Adjusts the tonal quality of the sound.	Adjusts the level of the effect sound mixed to the original sound.

DELAY module	
	This is a delay module that allows use of the hold function.

Delay	TAP HOLD MUTE
This is a long delay with a maximum setting of 5000 ms.	

PingPong Dly	TAP HOLD MUTE
This is a ping-pong type delay where the delay sound alternates between left and right.	

Echo	TAP HOLD MUTE
This effect simulates a tape echo with a long delay time of up to 5000 ms.	

AnalogDelay	TAP HOLD MUTE
This effect simulates an analog delay with a long delay time of up to 5000 ms.	

The above 4 effect types have the same parameters.

PARAM1	PARAM2	PARAM3	PARAM4
<b>Time</b>   1 – 5000	<b>FeedBack</b>   0 – 100	<b>Hi Damp</b>   0 – 10	<b>Mix</b>   0 – 100
Sets the delay time.	Adjusts the feedback amount.	Adjusts the treble attenuation of the effect sound.	Adjusts the level of the effect sound mixed to the original sound.

ReverseDelay	TAP HOLD MUTE
This is a reverse delay with a long delay time of up to 2500 ms.	

PARAM1	PARAM2	PARAM3	PARAM4
<b>Time</b>   10 – 2500	<b>FeedBack</b>   0 – 100	<b>Hi Damp</b>   0 – 10	<b>Balance</b>   0 – 100
Sets the delay time.	Adjusts the feedback amount.	Adjusts the treble attenuation of the effect sound.	Adjusts the balance between original sound and effect sound.

Air			
This effect reproduces the ambience of a room, to create spatial depth.			

PARAM1	PARAM2	PARAM3	PARAM4
<b>Size</b>   1 – 100	<b>Reflex</b>   0 – 10	<b>Tone</b>   0 – 10	<b>Mix</b>   0 – 100
Adjusts the size of the simulated space.	Adjusts the amount of reflections from the wall.	Adjusts the tonal quality of the sound.	Adjusts the level of the effect sound mixed to the original sound.

REVERB module	
	This module comprises various kinds of reverb, early reflections, and multi-tap delay.

Hall
This reverb effect simulates the acoustics of a concert hall.

Room
This reverb effect simulates the acoustics of a room.

Spring
This effect simulates a spring-type reverb.

Arena
This reverb effect simulates the acoustics of a large venue such as a sports arena.

TiledRoom
This reverb effect simulates the acoustics of a tiled room.

Modern Spring
This effect simulates a bright, transparent spring-type reverb.

The above six effect types have the same parameters.

PARAM1	PARAM2	PARAM3	PARAM4
<b>Decay</b>   1 – 30	<b>Pre Delay</b>   1 – 100	<b>Tone</b>   0 – 10	<b>Mix</b>   0 – 100
Sets the duration of the reverb.	Adjusts the delay between input of the original sound and start of the reverb sound.	Adjusts the tonal quality of the sound.	Adjusts the level of the effect sound mixed to the original sound.

E/Reflection			
This effect isolates only the early reflection components of the reverb.			

PARAM1	PARAM2	PARAM3	PARAM4
<b>Decay</b>   1 – 30	<b>Shape</b>   ±10	<b>Tone</b>   0 – 10	<b>Mix</b>   0 – 100
Sets the duration of the reverb.	Adjusts the envelope of the effect sound. In the negative range, the envelope is reversed. At 0, the effect is a gate reverb. In the positive range, the envelope is an attenuating envelope.	Adjusts the tonal quality of the sound.	Adjusts the level of the effect sound mixed to the original sound.

Multi TapDly			
This effect produces several components with different delay times.			

PARAM1	PARAM2	PARAM3	PARAM4
<b>Time</b>   1 – 3000	<b>Pattern</b>   1 – 8	<b>Tone</b>   0 – 10	<b>Mix</b>   0 – 100
Sets the basic delay time.	Selects the combination pattern for the taps. The selection ranges from rhythmical to random patterns.	Adjusts the tonal quality of the sound.	Adjusts the level of the effect sound mixed to the original sound.

Pan Delay			
This is a stereo delay with a delay time of up to 3000 ms.			

PARAM1	PARAM2	PARAM3	PARAM4
<b>Time</b>   1 – 3000	<b>FeedBack</b>   0 – 100	<b>Hi Damp</b>   0 – 10	<b>Pan</b>   L50 – L2, 0, R2 – R50
Sets the delay time.	Adjusts the feedback amount.	Adjusts the treble attenuation of the effect sound.	Adjusts the panning (left/right) position of the sound.



<b>Ping Pong Dly</b>			
This is a ping-pong delay with a delay time of up to 3000 ms.			
PARM1	PARM2		PARM3
<b>Time</b>	1 – 3000	<b>FeedBack</b>	0 – 100
Sets the delay time.	Adjusts the feedback amount.		Adjusts the treble attenuation of the effect sound.
PARM4			
<b>Mix</b>	0 – 100		
Adjusts the level of the effect sound mixed to the original sound.			

<b>Auto Pan</b>			
This effect cyclically moves the panning position of the sound.			
PARM1	PARM2		PARM3
<b>Width</b>	L50 – L2, 0, R2 – R50	<b>Rate</b>	0 – 50
Adjusts the range of sound position movement.	Adjusts the modulation rate.		Adjusts the modulation depth.
PARM4			
<b>Wave</b>	0 – 10		
Selects a waveform for modulation. Higher setting values result in stronger clipping, which emphasizes the auto-panning effect.			

<b>TOTAL/FUNCTION</b>		<b>TOTAL module</b>	
	This module comprises parameters that affect the entire patch.		
<b>TOTAL</b>			
Specifies the patch specific tempo and the action of the function foot switch.			
PARM1	PARM2		
<b>TEMPO</b>	40 – 250	<b>Function</b>	See page 34
Specifies the patch specific tempo (→ p. 35).	Selects the action of the [FUNCTION] (CH A/B) foot switch.		
<b>NAME</b>			
Specifies a name for the patch (→ p. 26).			
<b>ARRM</b>			
Makes settings for the ARRM function (→ p. 46). Use the [PAGE] key to switch between parameters 1 - 3 and 4, 5.			
<b>PAGE1</b>			
PARM1	PARM2	PARM3	
<b>ARRM control target</b>	<b>min (minimum value)</b>	See page 46	<b>MAX (maximum value)</b>
Selects the ARRM control target. When "NOT Assign" is selected, the ARRM function is disabled.	Specifies the parameter value that is set when the control waveform reaches its lowest point.	Specifies the parameter value that is set when the control waveform reaches its highest point.	
<b>PAGE2</b>			
PARM4	PARM5		
<b>Wave</b>	See page 47	<b>Sync</b>	See page 47
Selects the control target waveform.	Specifies control waveform synchronization using the patch specific tempo as reference.		

<b>PDL1</b>
Specifies control target 1. For details on expression pedal settings, see page 30.
<b>PDL2</b>
Specifies control target 2.
<b>PDL3</b>
Specifies control target 3.
<b>PDL4</b>
Specifies control target 4.

The above four effect types have the same parameters.

PARM1	PARM2	PARM3	PARM4
<b>Expression pedal control target</b>	<b>min (minimum value)</b>	<b>MAX (maximum value)</b>	<b>Module on/off function</b>
Specifies the expression pedal control target.	Specifies the parameter value that is set when the pedal is fully raised.	Specifies the parameter value that is set when the pedal is fully pushed down.	Enables or disables the module on/off function.

## Troubleshooting

### ■ No sound or very low volume

- Make sure that the POWER switch is on.
- Try adjusting the LEVEL knob.
- Make sure that the INPUT jack and the guitar, and the OUTPUT L/MONO (or OUTPUT R) jack and the guitar amp are connected properly.
- Make sure that the shielded cable is not defective.
- Try adjusting the patch level (→ p. 16).
- Make sure that the G7.1ut is not in mute mode (→ p. 20).
- For some patches, the volume can be adjusted with the expression pedal. Make sure that a suitable volume setting has been selected with the pedal.

### ■ Sound is distorted

- Try lowering the Gain and Level parameters of the PRE-AMP module.
- Try lowering the setting of the [TUBE] control and [BOOST] control.

### ■ Foot switches do not operate properly

- Check the setting of the function foot switch (→ p. 34).
- Check the current operation mode. The foot switch action is different in play mode and manual mode.

### ■ Sound in bypass condition is strange

- Try lowering the setting of the [TUBE] control and [BOOST] control.  
The Energizer operates also in the bypass condition.

### ■ Noise is noticeable

- Make sure that only a ZOOM AC adapter is used.
- Adjust the ZNR setting.

- Move around the room to check for RF noise in relation to the pick ups, etc.
- Try lowering the Gain and Level parameters of the PRE-AMP module.
- Check the settings of the built-in expression pedal (→ p. 30).  
Depending on the parameter assigned to the expression pedal, a pedal action causing drastic parameter change may result in noise.

### ■ Cannot send or receive MIDI messages

- Make sure that the MIDI IN connector of the G7.1ut and the MIDI OUT connector of the other MIDI device, and the MIDI OUT connector of the G7.1ut and the MIDI IN connector of the other MIDI device are connected properly.
- Check the MIDI channel setting (→ p. 37).
- Check whether send/receive of the respective type of MIDI message is enabled (→ p. 39, 42).

### ■ On/off switching with expression pedal does not work properly

- Verify that the module on/off function (parameter knob 4) is set to "Enable" for PDF1 - PDL4 in the TOTAL module (→ p. 31).

## Specifications

<b>Number of effect types</b>	92
<b>Number of effect modules</b>	9 simultaneously usable modules
<b>Patch memory</b>	User area : 4 patches x 20 banks = 80 (read/write enabled) Preset area : 4 patches x 20 banks = 80 (read only) Total: 160 patches
<b>Sampling frequency</b>	96 kHz
<b>A/D conversion</b>	24-bit, 64-times oversampling
<b>D/A conversion</b>	24-bit, 128-times oversampling
<b>Signal processing</b>	32-bit
<b>Frequency response</b>	20 Hz - 40 kHz +1.0 dB, -3.0 dB (10 kilohm load)
<b>Display</b>	2-digit 7-segment LED display 16-digit 2-line backlit LCD
<b>Inputs</b>	
<b>Guitar input</b>	Standard monaural phone jack Rated input level: -10 dBm Input impedance: 1 megohm
<b>AUX input</b>	Mini phone jack (stereo) Rated input level: -10 dBm Input impedance: 10 kilohms
<b>Outputs</b>	
<b>Line output</b>	Standard monaural phone jack x 2 Rated output level: -10 dBm/+4 dBm (switchable) Maximum output level: +19 dBm (into load impedance of 10 kilohms or more) Output impedance: 1 kilohm or less
<b>Headphone output</b>	Standard stereo phone jack Rated output: 60 m W (into 32-ohm load), 20 m W (into 300-ohm load) Output impedance: 47 kilohm
<b>Tube circuitry</b>	12AX7 x 1
<b>Control input</b>	FP01/FP02 input
<b>Control connectors</b>	MIDI OUT, MIDI IN
<b>USB interface</b>	
<b>PC interface</b>	16-bit (record/play, stereo)
<b>Sampling frequencies</b>	32 kHz, 44.1 kHz, 48 kHz
<b>Power requirements</b>	15 V AC, 1.5 A (from supplied AC adapter AD-0012)
<b>Dimensions</b>	235 (D) x 460 (W) x 81 (H) mm
<b>Weight</b>	4.0 kg
<b>Optional accessory</b>	Expression pedal FP02

## MIDI implementation chart

[EFFECTOR Model G7.lut ] MIDI Implementation Chart Date : 08.Oct.,2005 Version :1.00

Function ...	Transmitted	Recognized	Remarks
Basic Channel	Default Changed 1-16,OFF 1-16,OFF	1-16,OFF 1-16,OFF	
Mode	Default Messages Altered 3 x *****	3 x	
Note Number	x *****	x	
Velocity Note ON Note OFF	x x	x x	
After Touch	Key's Ch's x x	x x	
Pitch Bend	x	x	
Control Change	o 0,32 1-5,7-31,64-95  64-95	o 0,32 1-5,7-31,64-95  64-95	Bank select Expression Pedal, CONTROL IN Effect module on/off, Signal mute,Bypass, Channel A/B (See Note 1)
Prog Change	o 0-79 *****	o 0-127	
System Exclusive	o	o	
System Common	Song Pos Song Sel Tune x x x	x x x	
System Real Time	Clock Commands x x	x x	
Aux Messages	Local ON/OFF All Notes OFF Active Sense Reset x x x x	x x x x	
Notes	1. Control # 1-5,7-31,64-95 is assignable. 2. Transmit Control # and Recognized Control # that used in some function are same.		

Mode 1 : OMNI ON, POLY      Mode 2 : OMNI ON, MONO      o : Yes  
Mode 3 : OMNI OFF, POLY    Mode 4 : OMNI OFF, MONO    x : No

## ■ G7.1ut patch/bank number + program number assignment table

GROUP	BANK	PATCH NO.									
		1		2		3		4			
		Bank No. MSB LSB	Program No.	Bank No. MSB LSB	Program No.	Bank No. MSB LSB	Program No.	Bank No. MSB LSB	Program No.		
U	0	0	0	0	0	0	0	2	0	0	3
	1	0	0	4	0	0	5	0	0	6	7
	2	0	0	8	0	0	9	0	0	10	11
	3	0	0	12	0	0	13	0	0	14	15
	4	0	0	16	0	0	17	0	0	18	19
	5	0	0	20	0	0	21	0	0	22	23
	6	0	0	24	0	0	25	0	0	26	27
	7	0	0	28	0	0	29	0	0	30	31
	8	0	0	32	0	0	33	0	0	34	35
u	9	0	0	36	0	0	37	0	0	38	39
	0	0	0	40	0	0	41	0	0	42	43
	1	0	0	44	0	0	45	0	0	46	47
	2	0	0	48	0	0	49	0	0	50	51
	3	0	0	52	0	0	53	0	0	54	55
	4	0	0	56	0	0	57	0	0	58	59
	5	0	0	60	0	0	61	0	0	62	63
	6	0	0	64	0	0	65	0	0	66	67
	7	0	0	68	0	0	69	0	0	70	71
A	8	0	0	72	0	0	73	0	0	74	75
	9	0	0	76	0	0	77	0	0	78	79
	0	1	0	0	1	0	1	1	0	2	3
	1	1	0	4	1	0	5	1	0	6	7
	2	1	0	8	1	0	9	1	0	10	11
	3	1	0	12	1	0	13	1	0	14	15
	4	1	0	16	1	0	17	1	0	18	19
	5	1	0	20	1	0	21	1	0	22	23
	6	1	0	24	1	0	25	1	0	26	27
b	7	1	0	28	1	0	29	1	0	30	31
	8	1	0	32	1	0	33	1	0	34	35
	9	1	0	36	1	0	37	1	0	38	39
	0	1	0	40	1	0	41	1	0	42	43
	1	1	0	44	1	0	45	1	0	46	47
	2	1	0	48	1	0	49	1	0	50	51
	3	1	0	52	1	0	53	1	0	54	55
	4	1	0	56	1	0	57	1	0	58	59
	5	1	0	60	1	0	61	1	0	62	63
	6	1	0	64	1	0	65	1	0	66	67
	7	1	0	68	1	0	69	1	0	70	71
	8	1	0	72	1	0	73	1	0	74	75
	9	1	0	76	1	0	77	1	0	78	79

### **The FCC regulation warning (for U.S.A.)**

This equipment has been tested and found to comply with the limits for a Class B digital device, pursuant to Part 15 of the FCC Rules. These limits are designed to provide reasonable protection against harmful interference in a residential installation. This equipment generates, uses, and can radiate radio frequency energy and, if not installed and used in accordance with the instructions, may cause harmful interference to radio communications. However, there is no guarantee that interference will not occur in a particular installation. If this equipment does cause harmful interference to radio or television reception, which can be determined by turning the equipment off and on, the user is encouraged to try to correct the interference by one or more of the following measures:

- Reorient or relocate the receiving antenna.
- Increase the separation between the equipment and receiver.
- Connect the equipment into an outlet on a circuit different from that to which the receiver is connected.
- Consult the dealer or an experienced radio/TV technician for help.



ZOOM CORPORATION  
ITOHPIA Iwamotocho 2chome Bldg. 2F, 2-11-2, Iwamoto-cho,  
Chiyoda-ku, Tokyo 101-0032, Japan  
Web Site: <http://www.zoom.co.jp>

# G7.1ut Patch List

## DEMO

\*The grayed grid indicates the channel that will be selected when the patch is called up.  
 \*The pedal setting item indicates the module name (effect type name) and the parameter name.

Name of patches for Live   for Rec	PRE-AMP CHANNEL	PRE-AMP CHANNEL	Key effect	Function SW setting	Pedal setting
	A	B			
<b>LoudGain</b>	MS Crunch	DZ Drive	PdIMonoPitch	A/B	■ MOD (PdIMonoPitch) PdIPosi
U0-1   U0-1	This patch simulates the Deep setting of the Diezel amp known for its hard, high-gain tone, used extensively by bands such as Tool and Metallica. It is best suited to playing guitar with drop tuning. Combination with Gate produces a dramatic and startling sound. Channel A is a Marshall crunch sound.				
<b>CleanCMB</b>	FD Clean	VX Clean	ModernSpring	A/B	■ Volume
U0-2   U0-2	This ultra clean tone reproduces the saturation of a tube amplifier. Enjoy a choice of American Fender sound (channel A) or British Vox combo sound (channel B). For an even smoother tone, combine the patch with Energizer tube processing.				
<b>XOver</b>	OverDrive	OverDrive	TiledRoom	A/B	■ REV (TiledRoom) Mix ■ MOD (Chorus) Mix ■ DLY (Delay) Mix
U0-3   U0-3	Highly versatile overdrive sound great for the fusion and crossover genres popular in the eighties. When playing a guitar solo, make it soar by pushing the function switch to select channel B with higher gain.				
<b>TalkPDL</b>	UK Blues	HK Drive	CombFilter	A/B	■ REV (Hall) Mix ■ MOD (CombFilter) Frequency
U0-4   U0-4	Unique sound simulating a talk box. No need for a hose or a microphone. Make your guitar talk and make it sing simply by using the pedal and your playing skills. Channel A is a combo sound simulating the Marshall Bluesbreaker amp.				
<b>AcoJazz</b>	Aco.Sim	FD Clean	Hall	A/B	■ Volume
U1-1   U1-1	This patch uses the acoustic effect to modify the sound of an electric guitar in electroacoustic style. The beautiful ambience creates a Jazzy feel. Recommended for use with single-coil front pickups. Channel B provides the Fender Twin Reverb clean sound.				
<b>ModDIST</b>	BG Drive	BG Drive	Chorus	A/B	■ MOD (Chorus) Mix ■ REV (Arena) Mix
U1-2   U1-2	A combination of Mesa Boogie Rectifier and chorus, for playing those really fast passages. Make an arena reverberate with solid riffs or demonstrate daring feats of technique. Channel A is a variation with lower gain.				
<b>Morphing</b>	Z Clean	MS Drive	ReverseDelay	A/B	■ DLY (ReverseDelay) Balance ■ MOD (Ensemble) Mix ■ REV (Arena) Mix
U1-3   U1-3	Psychedelic morphing sound using reverse delay. Let the pedal take you from the real world (Arena) to the world of fantasy (Reverse Delay), and back again. Channel B gives a heavily distorted Marshall sound.				
<b>BlueNote</b>	FD Clean	US Blues	Delay , Tremolo	A/B	■ DLY (Delay) Mix ■ WAH (Tremolo) Depth ■ WAH (Tremolo) Rate
U1-4   U1-4	Crunch sound with a spatial feel that is perfect for Jazz and Fusion. Depending on your instrument and your preference, you can select Fender Twin Reverb '65 (channel A) or Fender Tweed Deluxe '53 (channel B).				
<b>Flange</b>	VX Clean	HotBox	Flanger	Flanger on	■ PRE-AMP (HotBox) Gain
U2-1   U2-1	This flanger based jet sound is the signature sound of hard rock. Moving the pedal in the recording patch (u2-1) gives you two fighter planes that cross the stage from right and left. Channel A is a clean sound suitable for arpeggios.				
<b>FazeFunk</b>	FD Clean	VX Clean	Phaser	Step on	■ REV (E/Reflection) Mix ■ WAH (Phaser) Rate
U2-2   U2-2	Compressor + phaser effect great for funky cutting. Besides the normal phaser, you can call up the step effect with the function switch. Create that funky groove by alternating between brushing and single-note riffs. Channel A provides a clean sound variation using the Fender Twin Reverb simulation.				
<b>HarmonyC</b>	VX Clean	VX Crunch	H.P.S	Delay TAP	■ MOD (H.P.S) Mix
U2-3   U2-3	A patch that adds harmony in C major and delay to lead crunch sound. Why not try your hand at guitar orchestration using delay tap and harmonized pitch shifter. Channel A is a similar clean sound based on the Vox AC30TBX.				
<b>Big 0</b>	JC Clean	HK Drive	Octave	A/B	■ WAH (Octave) OctLevel
U2-4   U2-4	Octaver sound with the powerful low end of a bass guitar. Choose between clean (channel A) and drive (channel B) according to the song. Great for home recording, too, or when the bassist happens to be late.				
<b>Rotary</b>	Z Clean	UK Blues	ST-Chorus , AutoPan	A/B	■ WAH (Tremolo) Rate ■ MOD (ST-Chorus) Rate ■ REV (AutoPan) Rate ■ WAH (Tremolo) Depth
U3-1   U3-1	Spectacular rotary speaker simulation using three types of modulation. Use the function switch to change to the drive sound of channel B modeled on the Marshall Bluesbreaker amp, and modify the rotation speed with the pedal.				

## MODELING

\*The grayed grid indicates the channel that will be selected when the patch is called up.  
 \*The pedal setting item indicates the module name (effect type name) and the parameter name.

Name of patches for Live   for Rec	PRE-AMP CHANNEL	PRE-AMP CHANNEL	Key effect	Function SW setting	Pedal setting
	A	B			
<b>Rectify</b>	JC Clean	BG Drive	BG Drive	A/B	■ Volume
U3-2   U3-2	Simulates the high-gain sound of the Mesa Boogie Rectifier, a world-wide standard for heavy music. Warm sound with a strong presence provides a mighty buildup whether playing riffs or lead. Channel A is a clean sound with a standard combination.				
<b>J-Chorus</b>	JC Clean	JC Clean	ST-Chorus	ST-Chorus on	■ Volume
U3-3   U3-3	A simulation of the Roland JazzChorus sound with its beautiful chorus-based clean tone. Every guitarist needs a transparent clean sound with a wide range of uses, for cutting, arpeggios and many other situations. Stereo chorus can be turned on and off with the function switch, and channel A offers a tone variation of the same JazzChorus.				
<b>800/2000</b>	MS Crunch	MS Drive	Hall	A/B	■ Volume
U3-4   U3-4	This patch recreates both the Marshall JCM800 and JCM2000. Channel A is modeled on the characteristically solid crunch sound of the JCM800, while channel B brings you the higher gain sound of the JCM2000. Toggle between A and B with the function switch, for quick access to two types of Marshall sound.				
<b>Diezel</b>	DZ Drive	Z Stack	PdIMonoPitch	A/B	■ MOD (PdIMonoPitch) PdIPosi
U4-1   U4-1	A simulation of the Diezel Herbert high gain sound popular among guitarists who want that extra heavy impact. Dry and penetrating distortion not available with other amps sharply etches the outlines also of a heavily down-tuned guitar. Channel B is a Z Stack with super powerful midrange.				
<b>HiWatt</b>	HW Clean	HW Clean	Booster	Booster on	■ Volume
U4-2   U4-2	This patch is modeled on the clean tone of the Hiwatt Custom 100 with its lively midrange. The typical saturation characteristics of a tube amp are faithfully preserved, resulting in confident, responsive sound. Immerse yourself in the sultry clean tone of a British amp. Channel B is a tonal variation.				
<b>AC30TBX</b>	VX Clean	VX Crunch	TiledRoom	A/B	■ WAH (Tremolo) Rate
U4-3   U4-3	Simulation of the Vox AC30TBX crunch sound with the smooth high range typical of a class A amplifier, and its delicately detailed distortion. When you play a chord, the sound virtually jumps from the speaker in a way that is just not possible with other amps. Channel A gives the beautiful clean tone that is another hallmark of a class A amp.				
<b>TriAmp</b>	VX Clean	HK Drive	AnalogDelay	A/B	■ Volume
U4-4   U4-4	This patch simulates the smooth drive sound of the Hughes & Kettner Triamp MK II. Let the powerful low end and ample distortion propel your lead play. Channel A recreates the sound of the class A amp in the clean channel of the Triamp MK II, using VX Clean.				
<b>TweedDLX</b>	US Blues	US Blues	E/Reflection	A/B	■ REV (E/Reflection) Mix
U5-1   U5-1	Sound modeled on the Fender Tweed Deluxe beloved by many Blues greats. Dry crunch sound with just the right amount of sustain brings out those delicate shifts in dynamics that make all the difference. Lay your heart into your picking and let it flow. Channel B contains a variation of the Tweed Deluxe sound.				
<b>Breaker</b>	UK Blues	UK Blues	TiledRoom , Tremolo	A/B	■ WAH (Tremolo) Rate
U5-2   U5-2	The Marshall Bluesbreaker simulated by this patch is not an amp that provides heavy distortion like the Marshall JCM series. Its crunch sound faithfully follows each picking nuance and has the classic ring of British Blues in the vein of Eric Clapton. Channel B contains a variation with stronger drive feeling.				
<b>W Fender</b>	FD Clean	TweedBass	ModernSpring	A/B	■ MOD (ST-Chorus) Depth ■ MOD (ST-Chorus) Mix
U5-3   U5-3	Channel A of this patch contains the clean sound of a Fender Twin Reverb, while channel B recreates the crunch sound of the Fender Bassman. With these two great choices, you can make optimum use of chorus while playing a wide variety of styles.				

\* Please use patches "for Live" when you use guitar amp, and use patches "for Recording" when you connect your guitar directly to a recorder.

\* Banks A and B of the preset area contain the same patches as banks U and u.

\* We recommend you to adjust the parameter for the noise reduction according to your guitars and amps.

\* Such as product names and company names are all (registered) brand names or trade marks of each respective holders, and Zoom Corporation is not associated or affiliated with them. All product names, explanation and images are used for only purpose of identifying the specific products that were referenced during product development.

Continued overleaf >>



# G7.1ut Patch List

## ARTIST

\* The grayed grid indicates the channel that will be selected when the patch is called up.  
 \* The pedal setting item indicates the module name (effect type name) and the parameter name.

Name of patches for Live   for Rec	PRE-AMP CHANNEL	PRE-AMP CHANNEL	Key effect	Function SW setting	Pedal setting
	A	B			
<b>SalasWah</b> U5-4   U5-4	Z Clean	Guv'nor	AutoWah	A/B	■ Volume
This patch simulates the heavy auto wah sound of Stevie Salas. It uses the compressor + auto wah combination indispensable for true funk. Make free use of brushing and single-note cutting to play those groovy phrases. Channel A is a clean sound.					
<b>BeckOct</b> U6-1   U6-1	FD Clean	RAT	Octave	A/B	■ WAH (Octave) OctLevel
Simulates the octaver sound cherished by Jeff Beck. It's the ideal patch for playing passages in the fluid driving style of his famous song "Led Boots". Adjust the octaver level with the pedal. Channel A provides Fender Twin Reverb clean sound.					
<b>KingTone</b> U6-2   U6-2	FD Clean	UK Blues	Echo , ModernSpring	A/B	■ DLY (Echo) Mix ■ REV (ModernSpring) Mix
Clean tone like the choking guitar of the king of Blues, Mr. BB King. Recreate the moody solo from "The Thrill Is Gone", and use the pedal to control the ambience. Channel B has a drive sound modeled on the Marshall Bluesbreaker.					
<b>Hendrix</b> U6-3   U6-3	MS Crunch	FuzzFace	FuzzFace	A/B	■ MOD (Vibe) Rate ■ WAH (Phaser) Rate
The wild and mighty fuzz sound of guitar god Jimi Hendrix. Push the pedal down and be transported to Woodstock in 1969. Shake the earth with your thundering riffs. Channel A simulates the Marshall crunch sound.					
<b>Cream</b> U6-4   U6-4	Z Clean	UK Blues	ST-Chorus , AutoPan	A/B	■ WAH (Tremolo) Rate ■ MOD (ST-Chorus) Rate ■ REV (AutoPan) Rate
The Cream hit "Badge" which they also played at their reunion concert is driven by its beautiful melody and an enchanting combination of crunch and rotary speaker sound. That is the sound contained in this patch. By assigning multiple effects to the pedal, even the speed control of the rotary speaker is convincingly reproduced. Channel A is a clean sound variation.					
<b>ZZ Drive</b> U7-1   U7-1	FZ+M_Stk	FZ+M_Stk	Room	A/B	■ WAH (Booster) Gain
Simulates the special drive sound of Billy Gibbons who gained fame as the guitarist of ZZ Top. You can further boost the effect by pushing the pedal down. Hold your guitar way down low and start the hard boogie. Channel B is high-gain variation.					
<b>SRV</b> U7-2   U7-2	FD Clean	TS+F_Cmb	Vibe	A/B	■ MOD (Vibe) Rate ■ WAH (PedalVox) Frequency ■ MOD (Vibe) Balance
This patch is modeled on the definitive clean tone of Stevie Ray Vaughan. Great for fast chord cutting and dynamic stroking. Use heavy-gauge strings to play some Texas Blues. Channel B contains TS+F_Cmb drive sound.					
<b>SatchDST</b> U7-3   U7-3	DS-1	MS Drive	Flanger , PedalCry	A/B	■ WAH (PedalCry) Frequency
Simulates the lead tone of super guitarist Joe Satriani. The sound of the orange Boss DS-1, the proverbial distortion pedal, is a good match for phrases that require real mastery of technique. Channel B features high-gain Marshall sound.					
<b>LukeCLN</b> U7-4   U7-4	Z Clean	BG Drive	ST-Chorus	A/B	■ DLY (Delay) Mix ■ REV (Arena) Mix
Steve Lukather is largely responsible for the sophisticated sound of Toto that swept the world. In the eighties, he was using the clean tone that is simulated by this patch. Channel B will let you produce the flashy lead sound of the Mesa Boogie Rectifier. Classic rock'n roll has never sounded better.					
<b>Santana</b> U8-1   U8-1	BG Crunch	BG Crunch	PedalVox	A/B	■ WAH (PedalVox) Frequency
The Santana sound is popular among rock fans the world over, but the band also often collaborated with major Jazz artists. That sweet and drawn out Santana lead tone is simulated by this patch. Choke your guitar at the upper end and immerse yourself in "Europe". Channel A contains a variation with reduced drive.					
<b>B.Setzer</b> U8-2   U8-2	TweedBass	TweedBass	ModernSpring	A/B	■ REV (ModernSpring) Decay ■ REV (ModernSpring) Mix
The Rockabilly sound of Brian Setzer who became instantly famous for his "Dirty Boogie" album. The patch has a quality feel to it which will have you swinging in a heartbeat. The TweedBass sound in channel A has reduced gain and a less pronounced tone.					
<b>BrianDly</b> U8-3   U8-3	VX Crunch	PV Drive	PingPongDelay	A/B	■ DLY (PingPongDly) Mix
Simulates the sound of guitar magician Brian May who created the dramatic allure of Queen. The alternating right/left delay produces a highly unusual effect, turning your guitar into the Red Special. Channel A is a Vox crunch sound suitable for backing.					
<b>KurtDRV</b> U8-4   U8-4	Z Clean	BigMuff	Ensemble , Delay	A/B	■ MOD (Ensemble) Mix ■ DLY (Delay) Mix
In the nineties, Kurt Cobain of Nirvana changed the music scene forever, with his dramatic use of distortion and modulation. The crunch sound simulated by this patch will make you want to play those riffs from "Smells Like Teen Spirit". Channel A recreates the clean sound for the intro.					

## SPECIAL FX

\* The grayed grid indicates the channel that will be selected when the patch is called up.  
 \* The pedal setting item indicates the module name (effect type name) and the parameter name.

Name of patches for Live   for Rec	PRE-AMP CHANNEL	PRE-AMP CHANNEL	Key effect	Function SW setting	Pedal setting
	A	B			
<b>Bend4T</b> U9-1   U9-1	Z Clean	JC Clean	Bend Chorus	BPM TAP	■ MOD (Bend Chorus) Balance ■ DLY (Delay) Mix
Clean sound featuring the traditional ZOOM bend chorus. Play a solo with a Pop style bend, a great match for bands with alluring female vocals. Channel B is a clean sound variation using JazzChorus.					
<b>SFX5000</b> U9-2   U9-2	FD Clean	BigMuff	SlowAttack , Step	A/B	■ DLY (Echo) FeedBack ■ WAH (SlowAttack) Time ■ DLY (Echo) Mix
The 5-second delay time creates a cave-like echo. Play chords with a soft touch, or play artificial harmonics that enchants and elevates the listener. In a drastic change, channel B offers BigMuff fuzz sound.					
<b>ARRM Pit</b> U9-3   U9-3	FD Clean	HK Drive	Pedal Pitch	BPM TAP	■ Volume
A novelty sound that uses ARRM (Auto-Repeat Real-time Modulation) like an overturned toy box. In combination with ping-pong delay, you can enhance your guitar sound even further. Channel A provides Fender Twin Reverb clean sound.					
<b>Rvs&amp;Hold</b> U9-4   U9-4	FD Clean [off]	FD Clean [off]	ReverseDelay	Hold	■ DLY (ReverseDelay) Balance ■ WAH (Octave) OctLevel ■ MOD (ST-Chorus) Mix
This patch lets you hold a mysterious reverse sound. This can work effectively when used for the opening and ending during a live performance. Channel A is a tonal variation.					

\* Please use patches "for Live" when you use guitar amp, and use patches "for Recording" when you connect your guitar directly to a recorder.  
 \* Banks A and b of the preset area contain the same patches as banks U and u.  
 \* We recommend you to adjust the parameter for the noise reduction according to your guitars and amps.

\* Such as product names and company names are all (registered) brand names or trade marks of each respective holders, and Zoom Corporation is not associated or affiliated with them. All product names, explanation and images are used for only purpose of identifying the specific products that were referenced during product development.

## Setting recommendation on popular guitar amps

### Marshall JCM-2000

In case of patches for LIVE (U0~U9, A0~A9)

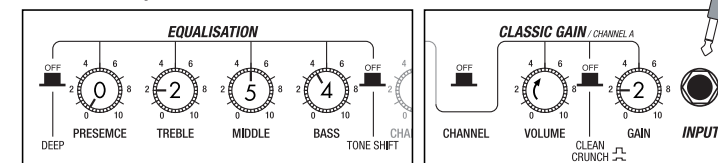

In case of patches for Recording (u0~u9, b0~b9)

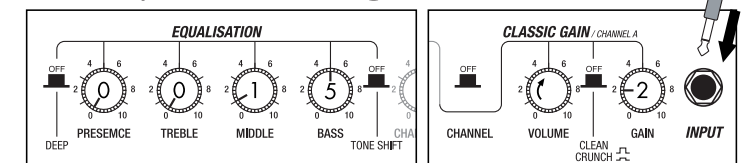

### Fender TWIN Reverb

In case of patches for LIVE (U0~U9, A0~A9)

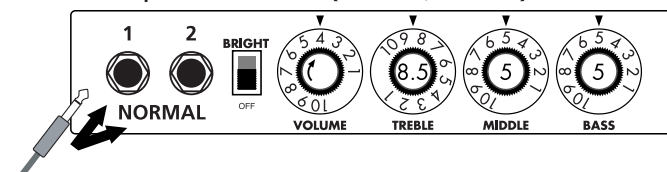

In case of patches for Recording (u0~u9, b0~b9)

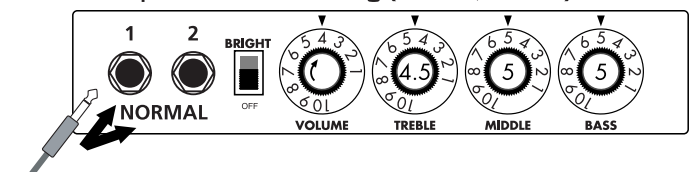

### Roland JC-120

In case of patches for LIVE (U0~U9, A0~A9)

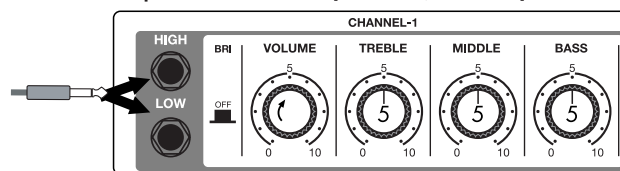

In case of patches for Recording (u0~u9, b0~b9)

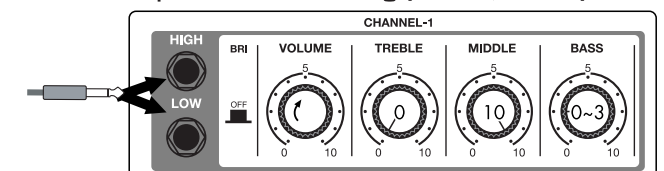

\* These are the recommended settings when the amp select setting is FRONT.  
 \* When you use guitar amp for recording patches, not only intended modeling sound will not existing, but also you hear harsh-sounding sometimes. Please adjust guitar amp setting as above reference.  
 \* The recommended settings shown above may have to be fine-tuned depending on the operating mode of the amplifier in use.



# G7.1 ut Modeling Description ①



## 35 AMP/STOMP BOX MODELS

Reference for drive effect types and its original models.

### ● Roland JAZZ CHORUS

EFFECT TYPE : JC Clean

Simply put, the Roland "JC-120" is the most familiar guitar amplifier among both professionals and amateurs. Released in 1975 from Roland, this amp became known as "portable", "loud" and "almost trouble-free" (which are the very characteristics Japanese products are known for!). You are pretty sure to find one in any live houses or studios all over the world. The key to that sound of "JC-120" is its unique chorus effect: the slightly delayed vibrato sound comes from one of two 12" loudspeakers and the dry sound from another and both sounds are combined in the air, which creates that distinctive spacey mood. This effect became very popular which is why Roland decided to release the chorus circuit independently as the "CE-1" pedal. Incidentally, the chorus effect on the G series is modeled after its follower "CE-2". Another unique feature of JC-120 is its "Bright" switch. This function is not included in this modeling program but you can approximate the effect of this switch by tweaking the "Harmonics" parameter in the "6 band EQ" section.

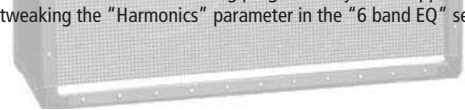

### ● Fender Tweed Deluxe '53

EFFECT TYPE : US Blues

The very first Fender amplifier was developed by Leo Fender and his trusty partner, the engineer Doc Kaufman in 1945-46. Actually, the earliest models were not made under the "Fender" brand but the "K&F Manufacturing Corporation" named after the initials of the two. The first amplifier using the "Fender" brand was the "Model 26" in 1947. In 1949, the entry models called "Champion 400/600" series followed. The so-called "Tweed Amps" covered literally with tweeds all over were developed during the 1950s and the 1960s. In these years, the company put out various tweed models like the "Bassman" or the "Bandmaster". The program of this G series is modeled after, among others, the most representative "Tweed Deluxe" aka the "Wide Panel" from 1953. This amplifier has a 12AX7 and a 12AX7 pre-tubes, two 6V6GT power-tubes, a 5Y3GT rectifier tube and a 12" Jensen loudspeaker and its output power is 10w. Recently the original amplifier is priced quite highly and is very difficult to find in good condition. This amp has two inputs but one is the input for a microphone. It has just one tone knob for treble control. Therefore, it is advisable to use this program on the G series with a flat tone setting except for the treble parameter so that you can enjoy the characteristic sound in the lower registers and the unique sound in the higher registers of the original Fender amp.



### ● MESA/BOOGIE Dual Rectifier

EFFECT TYPE : BG Drive

The "Rectifier" model has the improved simul-power circuitry (see the "Mark III" section) and the increased gain in the preamp section. This amp puts out 100w power and has five 12AX7 tubes for the pre-amp and four 6L6GC tubes for the power-amp. As opposed to the "Mark" series, the Rectifier has its tone control circuit after the volume circuit for better effect on the sound. Since this amp had been introduced, the brand image of MESA/BOOGIE has changed from being the premiere amp manufacturer for fusion music to that for heavy metal music. The most prominent feature of this amp is its rectifier circuitry after which it was named. The "Dual Rectifier" employs, as its name suggests, two different rectifier circuits: one uses silicon diodes and another uses tubes. When the diodes are selected, the amp gives you tight and highly powerful sound. When the tube rectifier circuit is selected, you will get a warmer sound. This program is modeled after the combination of a four-12" BOOGIE cabinet and the Dual Rectifier head using the vintage channel and the silicon-diode rectifier circuit.



### ● Fender Twin Reverb '65

EFFECT TYPE : FD Clean

In the later half of 1963, a reverb unit was added to the "Twin" amp, which was the birth of the "Twin Reverb" model. In 1965, Fender company was sold to CBS because of Leo Fender's health problem. The program on this Zoom G series is modeled after the pre-CBS "Twin Reverb" from 1965 aka "Black Panel". This amp has four 7025 (12AX7), a 12AX7 and two 12AT7 pre-tubes, four 6L6GC power-tubes and silicon diodes for the rectifier circuit. The diode rectifier is believed to give a tighter sound to the amplifier than the tube rectifier does, which should be the key to the characteristic glittering sound of this "Twin Reverb". This guitar amplifier has two 12" loudspeakers by Jensen and pus out 80w power. On the program in this G series, you can have the sound with the "Bright" switch on by tweaking the "Harmonics" parameter in the "6 band EQ" section. When you turn the reverb effect on, you will get that "Twin Reverb" sound you have been longing for.



### ● HIWATT Custom 100

EFFECT TYPE : HW Clean

The Custom 100 was the flagship amp from Hiwatt, a British manufacturer that ranks with Marshall among the British legends. Vintage Hiwatt amplifiers made before the mid-1980s use high-grade military-spec parts and hand-soldered point-to-point wiring. This is the reason why production was limited to about 40 units per month. Because of their solid construction, these amplifiers have been likened to tanks. Their sound, in a word, is the epitome of clean. The pre-stage tubes are ECC83, while the power tubes are the same EL34 as used by Marshall. Unlike the glittering clean sound of a Fender amp, the clean sound of a Hiwatt is darker, having that characteristic British tone. Especially in the "normal" channel, turning up the volume to maximum will simply increase the sound pressure, without breakup or loss of detail. In the high-gain "brilliant" channel, slight distortion is possible by connecting a guitar with a high-output pickup such as a Les Paul. But the sound always remains detailed and transparent, allowing the listener to clearly pick out the individual notes that make up a chord. The "normal" and "brilliant" channel inputs can be linked with a short shielded cable, for even higher sound pressure output. This effect type simulates the linked sound as described above, much favored by Pete Townshend of The Who and Pink Floyd's David Gilmour.



### ● Fender BASSMAN

EFFECT TYPE : TweedBass

Among the many famous Fender amps, the Bassman has earned a special place. When Jim Marshall developed his original amplifier, he is said to have used the Bassman circuit as a reference. When it first came out in 1951, the Bassman had an output of 26 watts and used a single Jensen 15-inch speaker. After various modifications, it reemerged in 1959 with a 50-watt output and four Jensen 10-inch drivers. The simulation of the Zoom G series is modeled on the "bright" channel of the '59 Bassman. Introduced at the 1951 NAMM show along with the Precision Bass, this amp was originally intended for use with bass guitars. But its reedy distortion made it a favorite with some of the early blues giants, and later with many rock guitarists. Of course, the amp continues to be used by musicians to this day.



### ● PEAVEY 5150 STACK

EFFECT TYPE : PV Drive

The "5150" and the "5150 MkII" were very famous guitar amplifiers originally developed as the signature models for Eddie Van Halen. Unfortunately, he doesn't use it anymore because of the expiration of the endorsement contract. The program on this G series is modeled after the first version of the "5150". This amplifier has two (Rhythm and Lead) channels and puts out 120w power using five 12AX7 pre-tubes and four 6L6GC power-tubes. The rectifier circuit employs silicon diodes. The uniqueness of the sound of this amplifier is characterized by its sharp attack, deep and smooth tone, fine distortion and fat and clinging low registers. The program is modeled after the combination of the Lead channel of the 5150 head and a "5150SL", a four-12" cabinet. Just crank up the gain and play one of Van Halen's hit "Top Of The World"!



### ● VOX AC30TBX (clean)

EFFECT TYPE : VX Clean

The long history of the VOX company harks back to the foundation of "Jennings Musical Instruments" (JMI) in 1958. Originally, this company made amplifiers with 10-15w output power but the musical trend required more powerful amplification, which resulted in the birth of the revered "AC30" guitar amp. The very original AC30 had two Celestion 12" loudspeakers using alnico magnets, EF86 pre-tubes, EL84 power-tubes and a GZ34 rectifier tube. The Shadows and the Beatles used this model and their influence helped this amp become popular among many guitarists. Later, as the musical trend required amplifiers with even more gain, the company developed an add-on device called "Top Boost Unit". The "AC30TBX", which this program in our G series is modeled after, is the later version of the AC30 with an integrated "Top Boost Unit". After the JMI had sold the VOX brand, the sales of the amplifier regrettably began to decline. However, the KORG Inc. acquired the VOX name recently and rejuvenated the brand by starting to manufacture truthful reissue models. In this G series, the program is modeled after the sound using the Hi input of the normal channel that will give you that clean guitar sound of the Beatles and the Shadows, which are the best examples of the distortion-free sound of the class-A operated amplifiers.



### ● Marshall JCM800

EFFECT TYPE : MS Crunch

Marshall has continued to produce great amplifiers for up-to-date musical trends in cooperation with the musicians. This brand started with its "JTM-45 (stands for Jim&Terry Marshall)" in 1962 and now its products are indispensable items in the modern Rock scene. Marshall seems to have been experimenting with different circuit designs of amplifiers but 1981 was the most prolific year for the brand because it released many new models like the "1959" and "1987" with four inputs, "2203" and "2204" with master volumes. In 1983, Marshall added the "2210" and "2205" with two (Normal and Boost) channels as well as effect send/return connectors to its lineup. These models also carried the collective designation "JCM (stands for Jim&Charles Marshall) 800". They had three ECC83 pre-tubes and four EL34 power-tubes. The tone control circuit was placed after the pre-amp section and this design seems to have become the standard for the modern Marshall amplifiers. For the modeling on this G series, we selected the "2203" with a master volume and it is quite easy to get the distortion. By today's standards, the amplifier's distortion is rather moderate, but the sound is very fat, the low-end is quite tight and, above all, the sound cuts through very well. When higher gain is required, this amplifier is often combined with overdrive or booster pedals. For the modeling, we used the head with a "1960A" cabinet that has four 12" loudspeakers and works very well with the "2203".

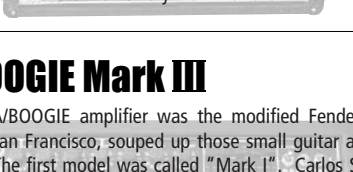

### ● MESA/BOOGIE Mark III

EFFECT TYPE : BG Crunch

The origin of the MESA/BOOGIE amplifier was the modified Fender Princeton. Randall Smith, an amp tech in San Francisco, souped up those small guitar amps to put out 100w power and sold them. The first model was called "Mark I!". Carlos Santana tried one and said, "Shit man, that little thing really Boogies!" -which gave the amplifier the brand name "BOOGIE." The second model "Mark II" had lead and rhythm channels and a 4-band equalizer to give wider variety to the guitar tone. The special feature of this model was an accomplished simul-power circuitry (the operation could be switched between class A and class AB). The power amplifier section had six power tubes. When the class A operation is selected, two EL34 power tubes are activated and the amp puts out a really smooth sound. When the class AB operation is selected, these two EL34s and other four 6L6GC power tubes are all activated and the amplifier puts out its full potential power. Until the model Mark II, MESA/BOOGIE amps were quite expensive, hand-made amplifiers, but the next model "Mark III" was more affordable. It has one 10" loudspeaker and 60w output power but retains all of the classic BOOGIE features; simul-power circuitry, the graphic EQ, and three (Rhythm1, Rhythm2 and Lead) separate channels. With this Zoom G series, you can select the modeling of the combo type of this "Mark III."



### ● Hughes & Kettner TriAmp MK2

EFFECT TYPE : HK Drive

Using a total of 13 tubes in the pre and power amp stages, and A and B settings in each of the three channels, this is a monster of an amplifier offering the equivalent of six channels to play with. AMP1 is a Fender type clean channel with bright and uncluttered sound. AMP2 is a classic British drive channel which covers the overdrive range from crunch to distortion. Both of these channels have fairly high gain, but they are surpassed by AMP3, which can be seen as the true highlight of this model. While allowing deep distortion, the sound has a solid core and remains wonderfully detailed. The simulation of the Zoom G series recreates the A channel of AMP3 which is distinguished by its bright character.



### ● VOX AC30TBX (Crunch)

EFFECT TYPE : VX Crunch

This legendary British amp is famous for its transparent clean tone, stemming from the Class A circuit designed by Dick Denney. But it also can produce impressively smooth drive sound with raised volume such as heard on the "Taxman" recording by the Beatles. The simulation is modeled on the "brilliant" channel of the AC30TBX to recreate the drive sound. Rory Gallagher and Brian May of Queen liked to boost the sound of this amp with a Rangemaster TrebleBooster made by Dallas-Arbitr, resulting in even more dramatic impact. With the Zoom G series, a similar result can be achieved by using the boost effect type of the WAH/EFX module.

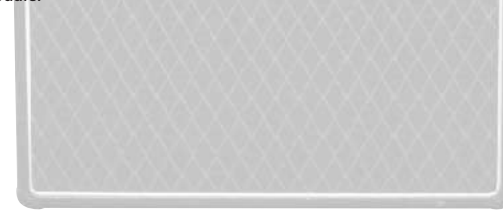

### ● Marshall 1962 Bluesbreaker

EFFECT TYPE : UK Blues

Since it was used by Eric Clapton when recording the album "John Mayall and the Blues Breakers with Eric Clapton" (commonly known as the "Beano" album), this amp has acquired the moniker "Bluesbreaker". Up to then, guitar amps aimed for a clean sound with minimal distortion, but the fat and sweet tone of this amp driven by Eric Clapton's Les Paul fascinated guitarists the world over. They liked it so much that it has become the defining sound of the rock guitar. While different from the distortion produced by modern high-gain amps, the long sustain and distortion following each picking nuance is ideal for playing the blues. The creamy sound of this amplifier with its four ECC83 pre-stage tubes, two 5881 power tubes, and a GZ34 tube in the rectifier circuit is perfectly captured by the simulation.



### ● Marshall JCM2000

EFFECT TYPE : MS Drive

"JCM2000" is based on the reputed "Plexi" amp (aka Old Marshall) whose rich overtones and powerful sound were legendary. It has very flexible sound and can produce the traditional Marshall sound, modern heavy metal sound or sounds suitable for any musical genre. It has the modern Marshall's standard circuit with four ECC83 pre-tubes and four EL34 power-tubes. It is an all-tube amplifier that can produce clean or heavily distorted sound and you can use it in all kinds of music. The sound is rather grainy but the response is fast and the guitar sound cuts through very well. "JCM2000" series has two different models: the TSL and the DSL. The program on the G series is modeled after the simply designed "DSL-100". As with the modeling of the "JCM800", we combined the head with a "1960A" cabinet and used the Lead channel that has more distortion.



### ● Diezel Herbert

EFFECT TYPE : DZ Drive

This modern three-channel amp features great tonal versatility, ranging from clean tone to distortion. Channel 1 is an ultra clean sound, but the amplifier is more famous for the extremely dry and gritty distortion produced by channel 3. This kind of drive sound that pierces the heart and rattles the ears is hard to get with any other amp. A DEEP control allows further boosting the low frequencies, a feature that is much in evidence in the modern heavy sound of bands such as Metallica or Limp Bizkit. The Zoom G series lets you produce a similar boost using the BASS EQ control.





# G7.1 ut Modeling Description ②

## BOSS OD-1

EFFECT TYPE : OverDrive

The "OD-1" released by BOSS in 1977 was originally developed for the simulation of the natural overdrive sound of tube amplifiers, but this stomp box turned out to be popular as the booster unit to connect to the input of the real tube amplifier to get tighter and more punchy sound with the increased gain. The "OD-1" employs the asymmetrical "clipper" section in its circuit design that uses three diodes to create the overdrive sound that is mild and rich in nuances. The pedal had been in production from 1977 to 1985, but now it is unexpectedly difficult to even find a used one. And if you could locate one, it would be astonishingly expensive. There have been many stomp boxes known as overdrive units. The most famous one is probably the "Tube Screamer" but we chose this very original overdrive pedal "OD-1". If you are lucky enough to use the real "OD-1", we invite you to try blind test to turn off all of the effect module except the "OD-1" on the Zoom G series and compare the sound of the modeling and that of the real one. We think that you will not hear any difference.

## Ibanez TS808

EFFECT TYPE : TS808

This is modeled on the early Tube Screamer introduced by Ibanez in 1979 for the non-US market. In Japan, it was sold under the Maxon name as the OD808. As the moniker implies, when using the pedal on its own, it produces natural distortion such as when driving a tube amp hard. But it often was used simply as a booster, with gain at 0 and volume at 10, to drive a full-up amp even further. Normally, this would not change the amplifier's sound, but a slight peak in the midrange results in a softer tone. This pedal is also famous for being used by blues guitar legend Stevie Ray Vaughan who tragically perished in a helicopter crash.

## KLON CENTAUR

EFFECT TYPE : Centaur

This pedal is well known for two things: its capability of producing pure distortion without impairing the original sound, and its high price. Being four-and-a-half years in the making, the Centaur distinguishes itself from other famous pedals such as the Ibanez TS808 or the Boss OD-1. It is also often used as a booster, but whereas these vintage pedals add their characteristics to the amp sound, the Centaur creates a tone as if it were driven by the amp.

## Marshall Guv'nor

EFFECT TYPE : Guv'nor

The initial sales talk for this serious distortion pedal "Guv'nor" bearing the Marshall brand was that you could get the distortion sound of the Marshall amps with this small stomp box. Depending on which guitar amps you combine, you can actually get the Marshall amps distortion. There are two different versions of the Guv'nor: the Britain-made ones from 1988 and the Korean-made ones from 1998. The program on this G series is modeled after the original version from 1988. The Guv'nor's characteristic feature is the frequency point you can tweak using the "TREBLE" control. Even if you lower this parameter value, the sound will get fat instead of getting dullish. As you raise the value, the sound will get sweeter and clearer.

## PROCO RAT

EFFECT TYPE : RAT

This is one of the most widely used pedals. It has only three knobs (Distortion, Filter, Volume), but each knob has a wide adjustment range, allowing various types of sound. With distortion fully turned up, the fat, up-front sound is close to a Fuzz pedal. At the twelve o'clock position, the crunch sound brings out those fine picking nuances, allowing the player to tweak the sound by varying the playing style. As opposed to a regular tone control, the filter knob cuts the treble when turned clockwise. This is the secret behind the typical "RAT" sound. In the Zoom G series, this effect is simulated by the TONE parameter, but operation is reversed (treble is cut when turned counterclockwise).

## BOSS DS-1

EFFECT TYPE : DS-1

This orange-colored pedal can be called the standard of distortion sound. Among the many distortion pedals from Boss, it is a real long-seller, along with the SD-1. In Japan, sales of the pedal ceased at one point (although production for the U.S. market continued), but as of 2005, the product is available again. This is the only Boss pedal to be reintroduced to the market in this fashion. The sound is trebly and very "distortion-like", but it can very well hold its own in a band. Favored by Joe Satriani and Nirvana's Kurt Cobain.

## MXR Distortion+

EFFECT TYPE : dist+

MXR, a company founded in the seventies by two high school students, is famous for stomp boxes such as the Dynacomp and Phase 90. In the early days, their products were actually built and painted in a garage and set out to dry in the garden. As the story goes, sometimes small insects would get stuck on the surface, and the lot would be shipped out as is. The pedals soon gained worldwide fame in the seventies, but eventually lost their market share to "Made in Japan" products from Boss and others that provided high performance at lower cost. MXR disappeared from the scene, but in the late eighties, Jim Dunlop bought the rights and is now producing a number of re-issue models.

This pedal much beloved by Randy Rhoads who made the "distortion" moniker and sound famous the world over. The hard-edged tone stays detailed also when playing fast solos or riffs with the lower strings muted. The world of heavy metal and hard rock wouldn't be the same without it.

## MATCHLESS HOT BOX

EFFECT TYPE : HotBox

The "HOT BOX" was released as a pedal preamp bearing the MATCHLESS brand. It uses two 12AX7A tubes for the truthful reproduction of the sound of the "MATCHLESS" guitar amplifiers. It has the compressed sound and the quick response, which are distinctive characteristics of tube amps. Its sound is fat and cuts through very well, too. Even if you crank up the gain to get a distorted sound, you will retain the nuances of the original guitar sound. Although it is categorized as preamp, the ideal way to get the best possible sound is to connect it, like usual stomp boxes, to the input of your guitar amp. Its design is also attractive: the case is polished like a mirror and the "MATCHLESS" logo lights up when you turn it on. This "Hot Box" is literally a magic box: you can get the signature sound of the "MATCHLESS" amps regardless of the guitar amplifier you connect it to.

## Dallas-Arbiter FUZZ FACE

EFFECT TYPE : FuzzFace

"FUZZ FACE" was originally released from the Dallas-Arbiter company in 1966 encased in a uniquely designed housing that literally looked like a face. It is also famous as legendary guitarist Jimi Hendrix's favorite gear. He combined this "FUZZ FACE" with his Marshall amps because it was hard to get distorted sound from them at that time, and created avant-garde tones. The heavy and fat low end and the fuzz sound with long sustain are the characteristics of this effective device. The earliest model used two PNP germanium transistors and was very different in sound from the later models using silicon transistors. The theory of creating distorted sound is simple. Have you tried to connect the guitar to a microphone input on your radio cassette recorder to emulate that sound? You cannot go too wrong if you think that the circuitry of this device is similar to that. The program on this G series is modeled after this earliest version most satisfactorily.

## Electro-Harmonix BIG MUFF

EFFECT TYPE : BigMuff

There are several versions of this pedal. The Zoom G series simulation is based on the so-called "Ram's Head" from the early seventies, characterized by very long sustain and rich distortion tapestry. Major names from the 70's associated with this sound are Carlos Santana and Robert Fripp of King Crimson. From the late eighties into the nineties, the grunge movement took over, with Nirvana's Cobain and J. Mascis of Dinosaur Jr. using the pedal to do their thing. Compared to an ordinary fuzz pedal, the BIG MUFF offers rich midrange and detailed distortion that maintain presence also when playing chords. The result is a wholly unique sound somewhere between distortion and fuzz.

## BOSS MT-2

EFFECT TYPE : MetalZone

The "MT-2" ("METAL ZONE") has the strongest distortion. Its unique distortion sound has very fat mid to low range and it has a parametric EQ in addition to the Hi and Low EQs, which is the key to the scooped metal sound. This stomp box is reputed for its flexibility in sound because you can not only get that scooped metal sound by cutting the mid range and boosting the high and low range but also the overdrive sound by reducing the gain and boosting the mid range. This is one of the best-selling stomp boxes among many of the popular line-ups of BOSS products. Once connected, the Strat or the Les Paul will have the "MT-2" sound regardless of the types of guitar pickups. It was first introduced in 1991 and is still in the BOSS's catalog; a truly a long-seller!

## Fender Combo + TS9

EFFECT TYPE : TS+F.Cmb

Opinion may be divided, but it can be argued that the most powerful and fat guitar sound ever was created by Stevie Ray Vaughan. He did this by putting extremely heavy-gauge strings that would fit an acoustic guitar on his old and battered Stratocaster. Add to this the full-up Fender amp and a small Ibanez pedal, and you are approaching magic territory. Just like this effect type does. Connect a Stratocaster and bend the third string near the 14th fret. Feel that smile appear on your face. If you want to express your feelings, give this one a go.

## Marshall Stack + SD-1

EFFECT TYPE : SD+M.Stk

Ever since the dawn of rock, Marshall has been recognized as the best brand of amp for this genre. With the JCM800 series that appeared in the eighties, Marshall again pulled ahead of the pack. Among the various models of the series, the most successful must be the 100-watt 2203 featuring a master volume control. With its crisp and solid sound, it makes the guitar stand out gloriously in a band even over the vocals, something that hard rock guitarists really appreciate. However, for dashing leads with heavy riffs or right-hand playing, gain with this amp alone was still not enough. Driving the Marshall JCM800 with an overdrive pedal was the answer. This effect type recreates the sound of those glitzy hairspray bands from the eighties, using the Boss SD-1 as overdrive pedal.

## Marshall Stack + FUZZ FACE

EFFECT TYPE : FZ+M.Stk

At the Monterey Pop Festival in 1967, a guitar was smashed and burnt on stage, helped along by Zippo lighter fluid. Just before this poor Stratocaster gave up the ghost, its psychedelic colors disintegrating, it had been played with furious intensity and produced a sound unlike anything heard before. And that is also what this effect type, combining a Marshall SuperLead 100 with the FUZZ FACE from Dallas-Arbiter, attempts to do. It produces a wildly deformed sound that is not destined for delicate chords but for audacious dramatic leads with heavy sustain. Such as those of the legendary Jimi Hendrix.

## Z Combo

EFFECT TYPE : Z Combo

The Bluesbreaker or Bassman are wonderful combo amps, but nowadays, their gain can seem a little low. Sometimes you just want to combine the transparency and dynamics of these combo amps with a more intense level of distortion and sustain. The Z Combo (great name!) is the answer to your prayers. You get a midrange sound like adding up a Marshall and a Fender and dividing them by two, plus distortion that equals notching up the volume from 10 to 15 (or from 12 to 17 on the Bassman). While not intended for jazz or heavy metal, the sound is great for a wide range of other blues and rock styles.

## Z Stack

EFFECT TYPE : Z Stack

Which amplifier has the strongest distortion in the world? Is it the Rectifier, the Herbert, the TriAmp? No, it is the Z Stack that you find right here. The distortion is so strong that simply touching the fingerboard with your left hand (or right hand if you're left-handed) will produce sound. (This makes right-hand playing a snap.) But amazingly, a 9th chord will remain clearly identifiable as such, because the sound does not lose its core. The biggest problem of this amplifier is that it does not exist—except in the Zoom G series, that is. Give it a try if you are after really heavy sound.

## Z OD

EFFECT TYPE : Z OD

When playing an electric guitar, distortion is of course one of the essential style elements, but different guitarists will have different preferences. What this effect type does is exemplify the preferences of the Zoom G series developers. The smooth overdrive sound should lend itself to many playing styles, allowing finely nuanced changes. Warmth is better than with any stomp box, and loud volume will not cause the sound to become unpleasant. Just the right amount of sustain ensures that attack dynamics remain vibrant. Tracking your fingerwork with uncanny accuracy, the effect reproduces even the final tinge of the pick when it leaves the string. We believe that many guitarists will find here what they were looking for.

## Extreme Distortion

EFFECT TYPE : ExtremeDS

This distortion program is developed especially for the G series. We deliberately made use of the characteristics of digital devices and even emphasized the edge of the digital sound to get the distortion to the maximum. The "TM-01" (Tri Metal) was the pedal that had the deepest distortion sound among the stomp boxes from ZOOM but was discontinued. It had as much as three diode-clipping stages and had very high gain. The "Extreme Distortion" is programmed to get the gain even higher. It raises the signal level to the maximum at the input stage and gets the wild distortion sound at the clipping stage. In fact, you won't change the distortion rate even if you lower the volume on your guitar! Its distortion is that deep. Contrary to the usual distortion effects whose sound gets thinner as you raise the gain, this "Extreme Distortion" won't lose the fatness and tightness of the sound.

## Digital Fuzz

EFFECT TYPE : DigIFuzz

Forty years ago, my fellow guitar player used to crank up his amp trying to distort his guitar sound and make other guys of the band virtually deaf at the end of the rehearsal. When it was difficult to get the distorted sound out of the amplifiers like in those days, some guys made cuts in the cone loudspeakers to make the sound distorted, which was the origin of the sound of fuzz effects. The fuzz pedals were developed to reproduce that distortion-like sound. In other words, the trick of fuzz effect is to simulate the dirty distortion and that "broken" feel. This "Digital Fuzz" has the very effect described above. Its drastic distortion, relentless cut-offs and noises in the decay are the characteristics that one could simply describe as "broken". Its fat and tight sound can be seriously recommended for the fuzz maniacs to try. This is literally the Digital Dirty Fuzz that is only possible in the digital domain (are you brave enough to make cuts in your loudspeakers?).

## Z Clean

EFFECT TYPE : Z Clean

This is a clean sound that makes the drive module virtually disappear. The bass is tight, and a very slight treble emphasis creates vigor. Why choose this effect type, then? Try it when creating patches for arpeggios and cutting. You should get smoother and more rounded sound. If you want to produce clean guitar sound via a line input, excessive bass may make it sound as if the pick got caught between the strings. This effect type should solve such problems.



## Cubase LE Installation

## Connections and Preparations

## Recording with Cubase LE

## Windows XP

To connect this unit to a computer running Windows XP and to enable audio input/output, proceed as follows.

### 1 Install Cubase LE on the computer.

When you insert the CD-ROM supplied with this product into the CD-ROM drive of the computer, the installer will start up automatically. Follow the on-screen instructions to install Cubase LE.

### 2 Connect this unit to the computer using a USB cable.

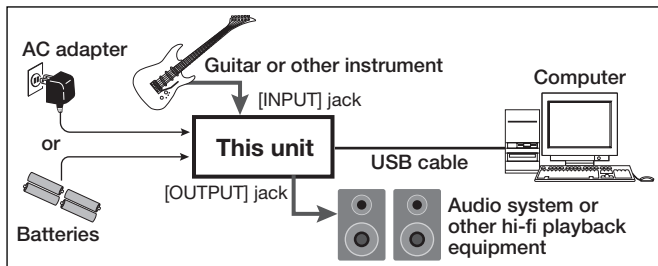

#### NOTE

- If you monitor the audio signal during recording via the audio output of the computer, there will be an audible latency. Be sure to use the [OUTPUT] jack of this unit to monitor the signal.
- When a device designed to use USB power is powered via the USB cable, insufficient power may result in unstable operation or error indications appearing on the display. In such a case, power the device from an AC adapter or batteries.
- Use a high-quality USB cable and keep the connection as short as possible. If power is supplied to a device designed to use USB power via a USB cable that is more than 3 meters in length, the low voltage warning indication may appear.

#### HINT

No special steps are necessary for canceling the USB connection. Simply disconnect the USB cable from the computer.

When you connect this unit for the first time to a computer running Windows XP, a message saying "New Hardware Found" will appear. Before proceeding, wait a while until this message disappears.

### 3 From the "Start" menu, select "Control Panel" and double-click "Sounds and Audio Devices".

The sounds and audio devices properties screen appears. Click the "Audio" tab and check whether "USB Audio CODEC" is selected as default device for audio playback and recording.



If another device is selected, use the "Default Device" pull-down menu to change the selection to "USB Audio CODEC". When the setting has been made, click the OK button to close the sounds and audio devices properties screen.

### 4 Start Cubase LE.

A window asking whether to check the audio input/output port appears. Click OK to perform the check.

### 5 After Cubase LE has started up, access the "Devices" menu, select "Device Setup..." and click "VST Multitrack" in the list of devices.



Check whether "ASIO Multimedia Driver" is selected as ASIO driver in the right part of the device setup window.

### 6 Click the "Control Panel" button in the device setup window. In the window that appears, click the "Advanced Options" button.

In the advanced options window, check whether "USB Audio CODEC" is selected as input port and output port.

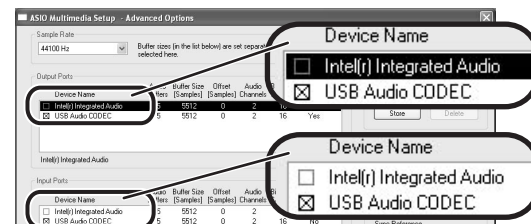

If not selected, click the respective box to place a check mark in it. When the setting has been made, click the OK buttons to close the windows and return to the normal post-startup Cubase LE screen.

#### HINT

- By clicking the Move up/Move down button in the advanced options window, you can change the priority sequence setting of the currently selected port. If you move "USB Audio CODEC" to the top of the list, it will also be at the top in the following VST input window.
- When you edit any of the settings in the advanced settings window, a window asking whether to check the audio input/output port appears. Click OK to perform the check.

### 7 Access the "Devices" menu and select "VST Inputs". The VST inputs window appears. Check whether the input port is active.



If the Active button is Off (grayed out), click the button to set it to On.

#### HINT

When multiple input ports are available for selection, you should scroll or enlarge the window and check the enable/disable settings for all ports.



## Cubase LE Installation

## Connections and Preparations

## Recording with Cubase LE

## MacOS X

To connect this unit to a computer running MacOS X and enable audio input/output, proceed as follows.

### 1 Insert the CD-ROM supplied with this product into the CD-ROM drive of the Macintosh computer.

The "Cubase LE" icon appears on the desktop.

### 2 Double-click the icon to open it, and use the "Cubase LE Installer" to install Cubase LE.

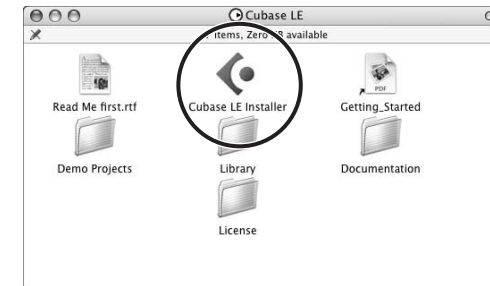

### 3 Connect this unit to the computer using a USB cable.

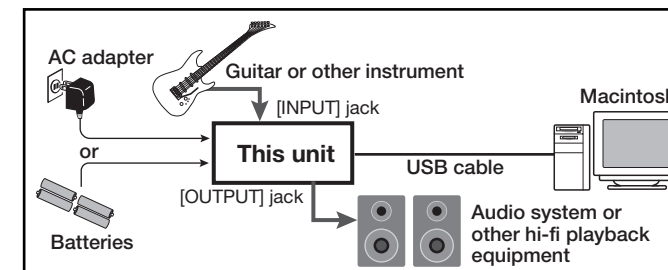

#### NOTE

- If you monitor the audio signal during recording via the audio output of the computer, there will be an audible latency. Be sure to use the [OUTPUT] jack of this unit to monitor the signal.
- When a device designed to use USB power is powered via the USB cable, insufficient power may result in unstable operation or error indications appearing on the display. In such a case, power the device from an AC adapter or batteries.
- Use a high-quality USB cable and keep the connection as short as possible. If power is supplied to a device designed to use USB power via a USB cable that is more than 3 meters in length, the low voltage warning indication may appear.

#### HINT

No special steps are necessary for canceling the USB connection. Simply disconnect the USB cable from the computer.

### 4 Open the "Applications" folder and then the "Utilities" folder, and double-click "Audio MIDI Setup".

The Audio MIDI Setup screen appears. Click "Audio Devices" and check whether "USB Audio CODEC" is selected as default input/default output.

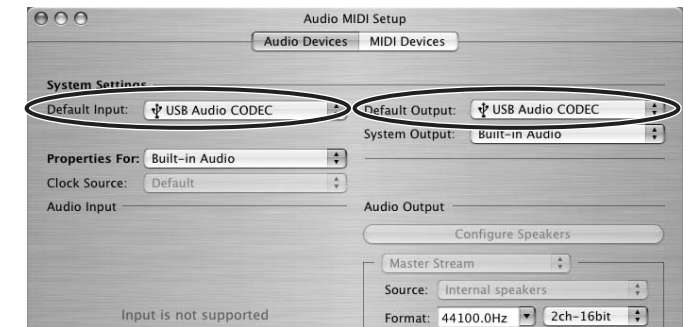

If another device is selected, use the pull-down menu to change the selection to "USB Audio CODEC". When the setting has been made, close Audio MIDI Setup.

### 5 Start Cubase LE.

#### HINT

The Cubase LE program is installed in the "Applications" folder.

### 6 When Cubase LE has started up, access the "Devices" menu, select "Device Setup...", and click "VST Multitrack" in the list of devices.

Check whether "USB Audio CODEC(2)" is selected as ASIO driver in the right part of the device setup window.

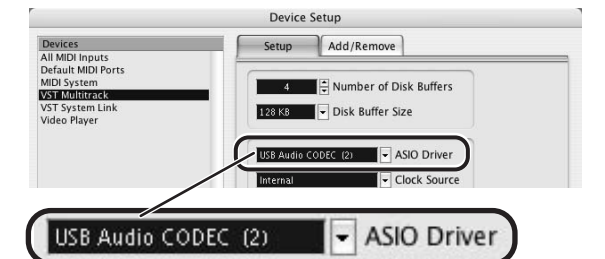

If another item is selected, use the pull-down menu to change the selection. When the setting has been made, click the OK button to close the window.

### 7 Access the "Devices" menu and select "VST Inputs". The VST inputs window appears. Check whether the input port is active.

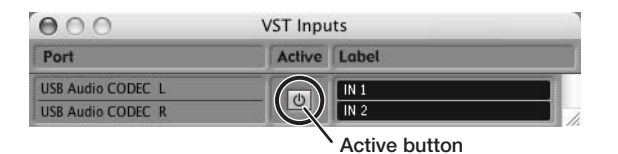

If the Active button is Off (grayed out), click the button to set it to On.



**8 Access the "File" menu and select "New Project".**

The new project window appears. Here you can select a project template.

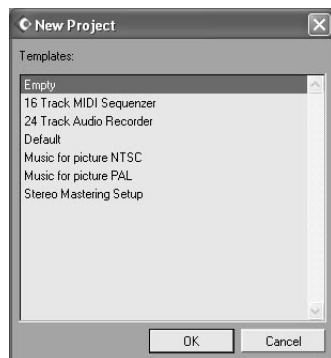
**9 Make sure that the "Empty" template is selected, and click the OK button.**

A window for selecting the project file save location appears.

**10 After specifying the project file save location (such as the desktop), click the OK button (Choose button in MacOS 10.4).**

A new project is created, and the project window for controlling most of the Cubase LE operations appears.

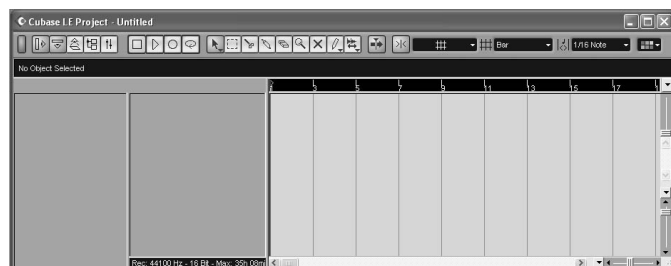

Project window

**11 To create a new audio track, access the "Project" menu and select "Add track". In the submenu that appears, select "Audio".**

A new audio track is added to the project window.

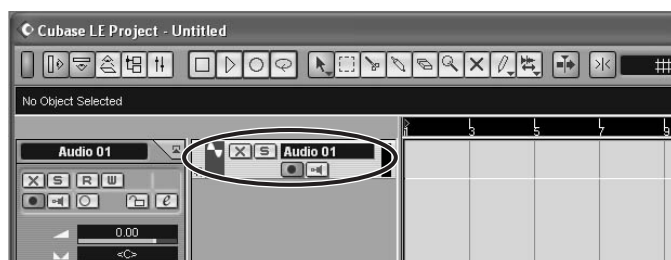
**HINT**

You can add several tracks at once by accessing the "Project" menu, selecting "Add track" and then selecting "Multiple..." in the submenu.

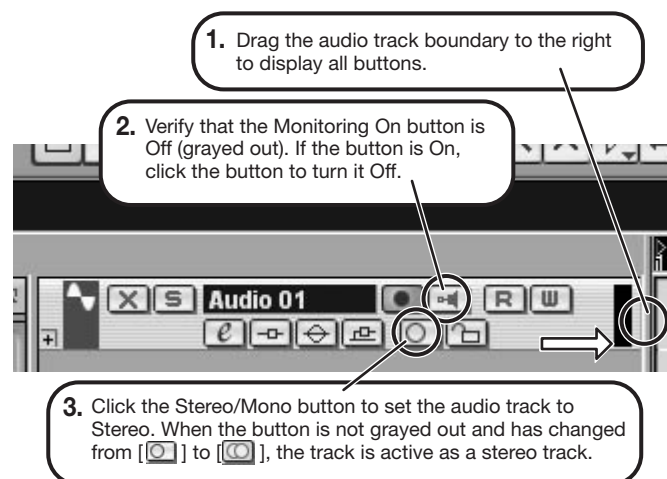
**12 Make the following settings for the new audio track.****13 Access the "Devices" menu and select "VST Inputs".**

The VST inputs window appears. This window shows the available input ports and their active/inactive status.

You can perform the following steps here.

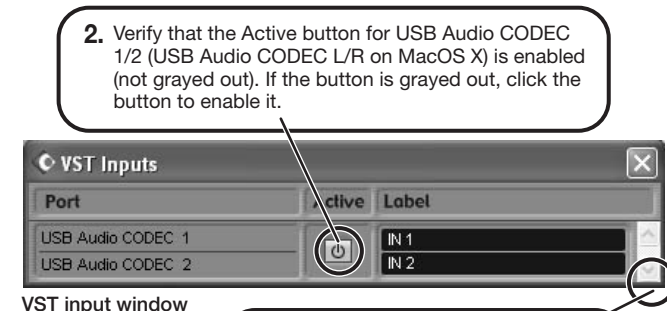

VST input window

**14 Connect the guitar or other instrument to the [INPUT] jack of this unit and select the desired patch.**

The sound selected here will be recorded on the computer via the [USB] port.

**15 Access the "Devices" menu and select "Mixer".**

The mixer window appears. This window shows the channels assigned to created tracks.

You can perform the following steps here.

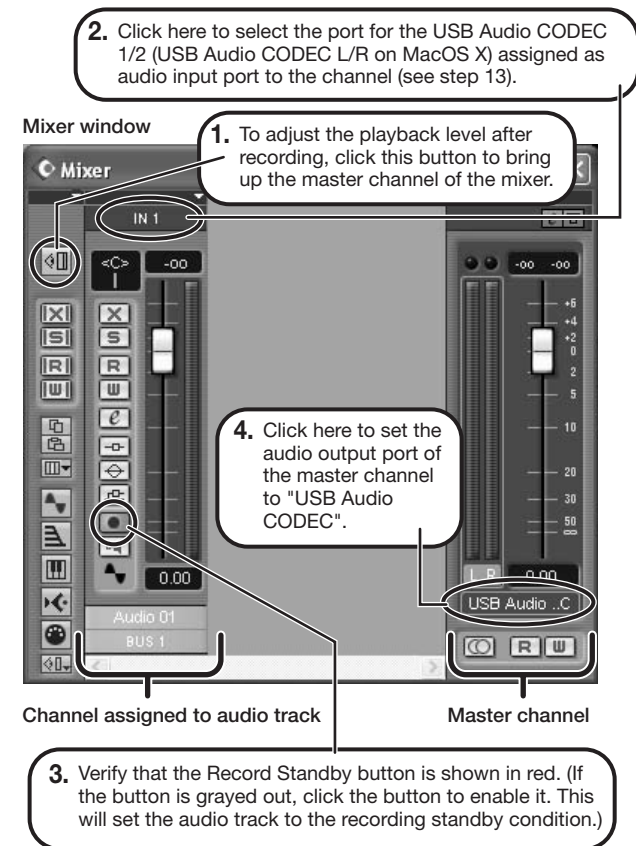

Channel assigned to audio track

Master channel

**HINT**

When the Record Standby button is enabled, the level meter next to the fader shows the input level for the audio track. When the button is disabled, the output level for the audio track is shown.

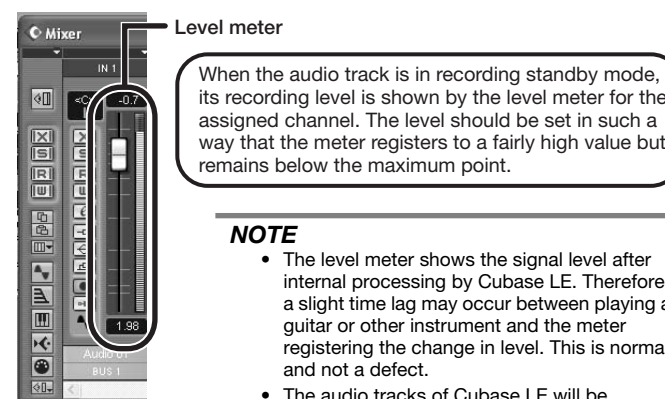
**16 While playing your instrument, adjust the output level of this unit to achieve a suitable recording level for Cubase LE.****NOTE**

- The level meter shows the signal level after internal processing by Cubase LE. Therefore a slight time lag may occur between playing a guitar or other instrument and the meter registering the change in level. This is normal and not a defect.
- The audio tracks of Cubase LE will be recorded with correct timing exactly matched to your instrument play. There will be no lag between already recorded tracks and newly added tracks.

**17 Verify that the transport panel is shown.**

Transport panel

If the transport panel is not shown, access the "Transport" menu and select "Transport Panel".

**18 To start recording, click the Record button in the transport panel.**

As you play your instrument, the waveform appears in real time in the project window.

**19 To stop recording, click the Stop button in the transport panel.**

Recording stops.

**20 Check the recorded content.**

To play the recording, perform the following steps.

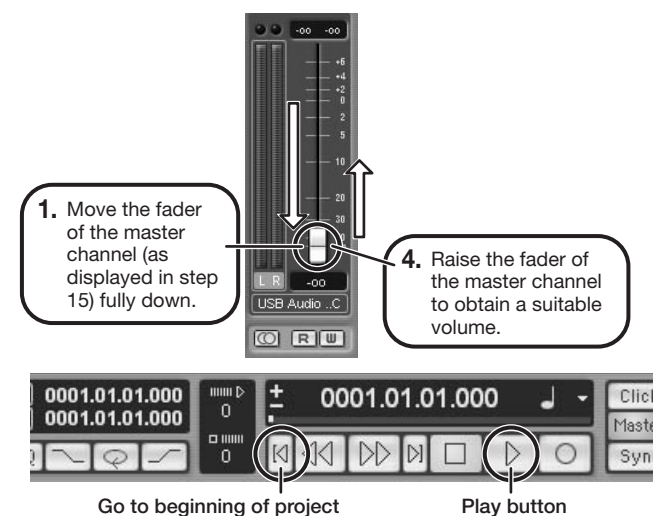

Go to beginning of project

Play button

**HINT**

If no sound is heard when you click the Play button after recording, check the settings in the VST input window (step 13) and the master channel output port setting (step 15) once more.

**For optimum enjoyment**

While using Cubase LE, other applications may slow down drastically or the message "Cannot synchronize with USB audio interface" may appear. If this happens frequently, consider taking the following steps to optimize the operation conditions for Cubase LE.

- (1) **Shut down other applications besides Cubase LE.**  
In particular, check for resident software and utilities.
- (2) **Reduce plug-ins (effects, instruments) used by Cubase LE.**  
When there is a high number of plug-ins, the computer's processing power may not be able to keep up. Reducing the number of tracks for simultaneous playback can also be helpful.
- (3) **Power the unit from an AC adapter**  
When a device designed to use USB power is powered via the USB port, the current supply may sometimes fluctuate, leading to problems. See if using an AC adapter improves operation.

If applications still run very slowly or the computer itself does not function properly, disconnect this unit from the computer and shut down Cubase LE. Then reconnect the USB cable and start Cubase LE again.



Cubase LE 4 installation    Connections and preparation    Use Cubase LE 4 to record    **Windows Vista / XP**

To connect this unit to a computer running Windows Vista (or Windows XP) and to enable audio input/output, proceed as follows. The installation description uses Windows Vista as an example.

**1** Download the latest ASIO driver from the web site of ZOOM Corporation (<http://www.zoom.co.jp>) and install the driver.

The ASIO driver software is required to enable use of Cubase LE 4 for audio input and output with a computer. Refer to the read\_me file included in the download package for instructions on how to install the driver correctly.

**2** Insert the supplied "Cubase LE 4" DVD-ROM into the DVD drive of the computer, and perform the installation steps.

When you insert the DVD-ROM, a screen asking what you want to do appears. Select "Open folder to view files". When the contents of the DVD-ROM are shown, open the "Cubase LE 4 for Windows" folder by double-clicking on it, and then double-click the executable "Setup" ("Setup.exe") file to start the installation process.



**HINT**

If nothing happens when you insert the DVD-ROM, open the Start menu and select "Computer" ("My Computer" in Windows XP). Then double-click the "Cubase LE 4" DVD-ROM icon to display the contents of the DVD-ROM.

**NOTE**

When the installation of Cubase LE 4 is complete, a screen asking about installation of activation (software license authentication) management software appears. Install this software, because it is required for registering Cubase LE 4.

**3** Connect this unit to the computer using a USB cable.

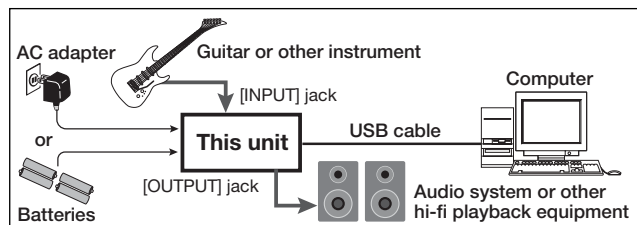

**NOTE**

- If you monitor the audio signal during recording via the audio output of the computer, there will be an audible delay. Be sure to use the [OUTPUT] jack of this unit to monitor the signal.
- When this unit is operated on USB bus power via the USB cable, insufficient power may result in unstable operation or error indications appearing on the display. In such a case, power the device from an AC adapter or batteries.
- Use a high-quality USB cable and keep the connection as short as possible. If USB bus power is supplied to this unit via a USB cable that is more than 3 meters in length, the low voltage warning indication may appear.

**HINT**

No special steps are necessary for canceling the USB connection. Simply disconnect the USB cable from the computer.

When you connect this unit for the first time to a computer running Windows Vista, a message saying "New Hardware Found" will appear. Before proceeding, wait a while until this message disappears.



**4** Bring up the "Sound" window from the Control Panel and make the input device setting for the computer.

To bring up the "Sound" window, select "Control Panel" from the Start menu and click "Hardware and Sound", then click "Sound".

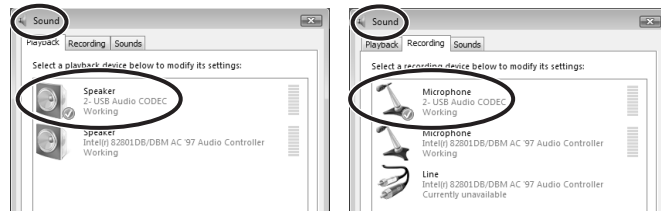

In the "Sound" window, verify that "USB Audio CODEC" is listed under the Play and Record devices and that the device is checked. (To switch between Play and Record, click the tabs at the top of the window.)

If the device is not checked, right-click on the icon for the device and click "Set as Default Device" so that a check mark appears.

**5** Start Cubase LE 4. Then access the "Devices" menu, select "Device Setup..." and click "VST Audio System".

To start Cubase LE 4, double-click the Cubase LE 4 shortcut icon that was created on the desktop. After startup, select "ZOOM ASIO Driver" as the ASIO driver in the right section of the Device Setup window. When you change the ASIO driver selection, a confirmation message appears. Click the "Switch" button.

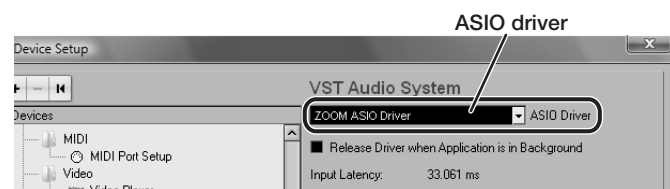

The device indication in the left section of the window now shows "ZOOM ASIO Driver" as the ASIO driver. Click on this indication to select it, and then click the "Control Panel" button in the right section of the Device Setup window.

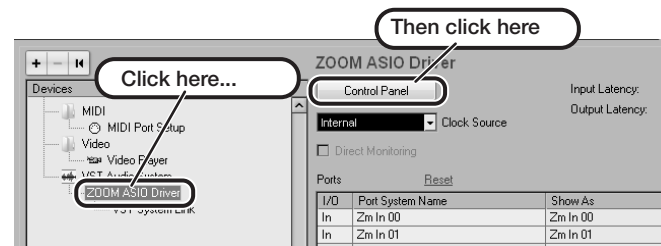

The window that appears lets you set the latency and sampling frequency for the ASIO driver. The latency should be set to a value that is as low as possible without causing sound dropouts during recording and playback.

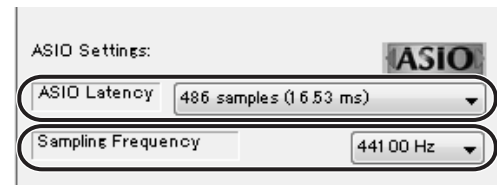

When the setting is complete, click the OK buttons in the respective windows to return to the startup condition of Cubase LE 4.

Cubase LE 4 installation    Connections and preparation    Use Cubase LE 4 to record    **MacOS X**

To connect this unit to a computer running MacOS X and enable audio input/output, proceed as follows.

**1** Insert the supplied "Cubase LE 4" DVD-ROM into the DVD drive of the Macintosh.

The contents of the DVD-ROM appear automatically. If nothing happens when you insert the DVD-ROM, double-click the "Cubase LE 4" icon shown on the desktop.

**2** Install Cubase LE 4 on the Macintosh.

When the contents of the DVD-ROM appear, open the "Cubase LE 4 for MacOS X" folder by double-clicking it, and then double-click the "Cubase LE 4.mpkg" file to start the installation process.

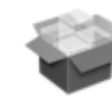

Cubase LE 4.mpkg

**3** Connect this unit to the computer using a USB cable.

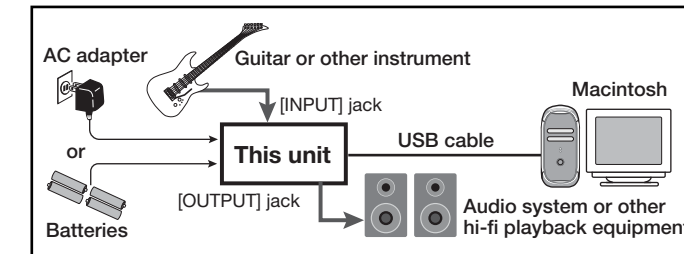

**NOTE**

- If you monitor the audio signal during recording via the audio output of the computer, there will be an audible delay. Be sure to use the [OUTPUT] jack of this unit to monitor the signal.
- When this unit is operated on USB bus power via the USB cable, insufficient power may result in unstable operation or error indications appearing on the display. In such a case, power the device from an AC adapter or batteries.
- Use a high-quality USB cable and keep the connection as short as possible. If USB bus power is supplied to this unit via a USB cable that is more than 3 meters in length, the low voltage warning indication may appear.

**HINT**

No special steps are necessary for canceling the USB connection. Simply disconnect the USB cable from the computer.

**4** Open the "Applications" folder and then the "Utilities" folder, and double-click "Audio MIDI Setup".

The Audio MIDI Setup screen appears. Click "Audio Devices" and check whether "USB Audio CODEC" is selected as default input/default output.

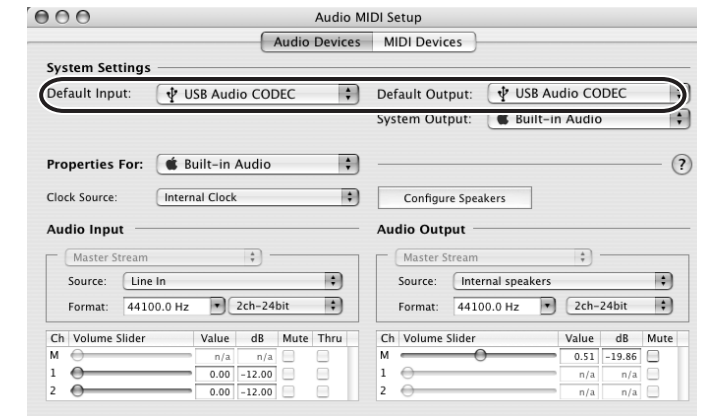

If another device is selected, use the pull-down menu to change the selection to "USB Audio CODEC". When the setting has been made, close Audio MIDI Setup.

**5** Start Cubase LE 4. Then access the "Devices" menu, select "Device Setup..." and click "VST Audio System".

To start Cubase LE 4, double-click on the Cubase LE 4 icon that was placed in the "Applications" folder during installation. After startup, be sure to verify that "USB Audio CODEC (2)" is selected as ASIO driver in the right section of the Device Setup window.

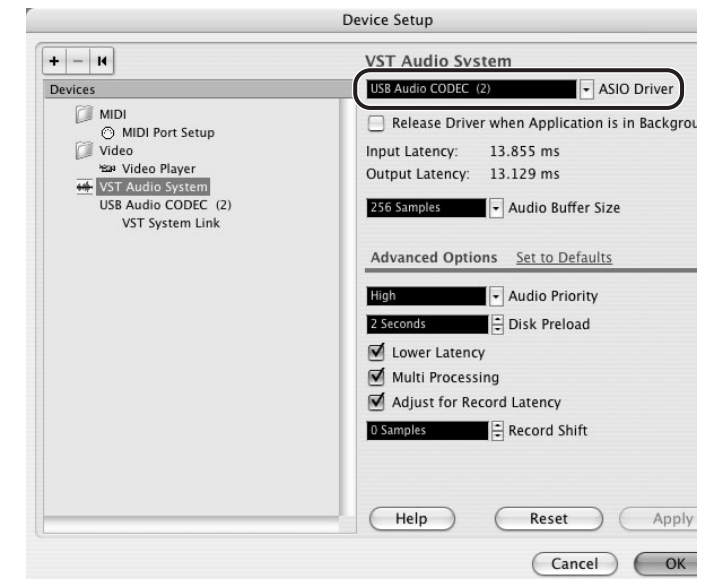

If another item is selected, use the pull-down menu to change the selection to "USB Audio CODEC (2)". When the setting has been made, click the OK button to close the window.



- 6** From the "Devices" menu of Cubase LE 4, select "VST Connections" and select the device containing the string "Zm In (Out)" ("USB Audio CODEC" for MacOS X) as input port and output port.

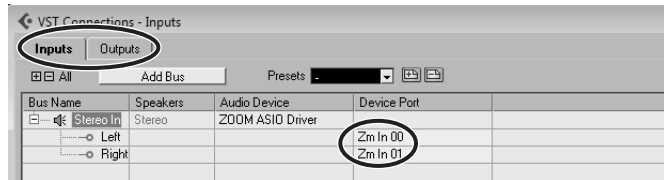

Use the tabs at top (top center for Mac OS X) left to switch between input and output, and verify that "Zm In (Out)" is selected as device port. If another device is selected, click the device port field and change the selection.

- 7** Access the "File" menu and select "New Project".

The new project window appears. Here you can select a project template.

- 8** Make sure that the "Empty" template is selected, and click the OK button.

A window for selecting the project file save location appears.

- 9** After specifying a suitable project file save location (such as the desktop), click the OK button (Choose button in MacOS X).

A new project is created, and the project window for controlling most of the Cubase LE 4 operations appears.

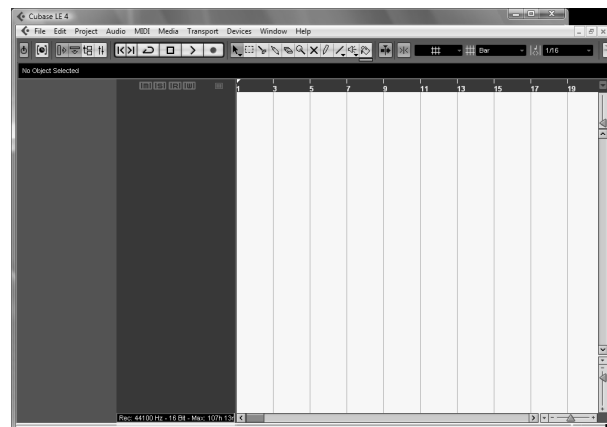

Project window

- 10** To create a new audio track, access the "Project" menu and select "Add track". In the submenu that appears, select "Audio".

The Add Track window for specifying the number of audio tracks and the stereo/mono setting appears.

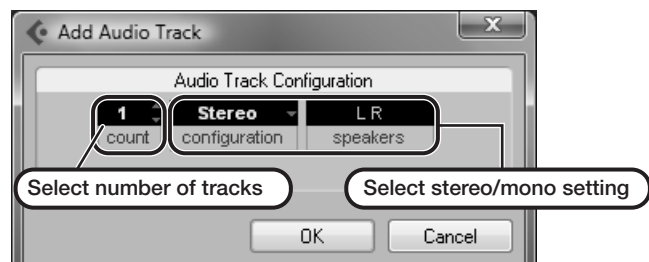

In this example, set the number of tracks to "1" and select stereo, then click the OK button.

A new stereo audio track is added to the project window.



- 11** Make the following settings for the newly created audio track.

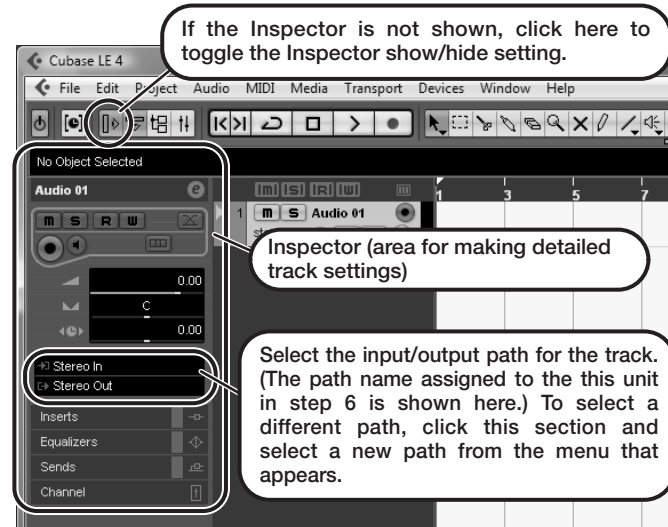

#### HINT

The Inspector shows information about the currently selected track. If nothing is shown, click on the track to select it.

- 12** Connect the guitar or other instrument to the [INPUT] jack of this unit and select the desired patch.

The sound selected here will be recorded on the computer via the [USB] port.

- 13** Access the "Devices" menu of Cubase LE 4 and select "Mixer".

The mixer window appears.

This window shows the channel assigned to the created track, and the master channel.

Perform the following steps here.

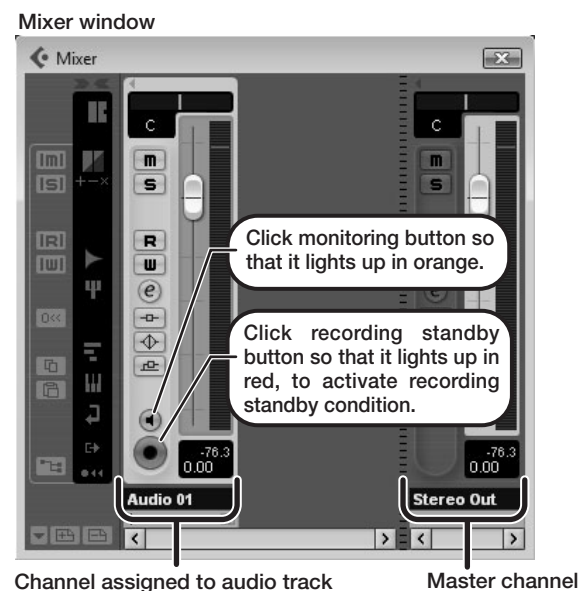

Channel assigned to audio track

Master channel

#### HINT

When the monitoring button is enabled, the level meter next to the fader shows the input level to the audio track. When the monitoring button is disabled, the meter fader shows the audio track output level.

- 14** While playing your instrument, adjust the output level of this unit to achieve a suitable recording level for Cubase LE 4.

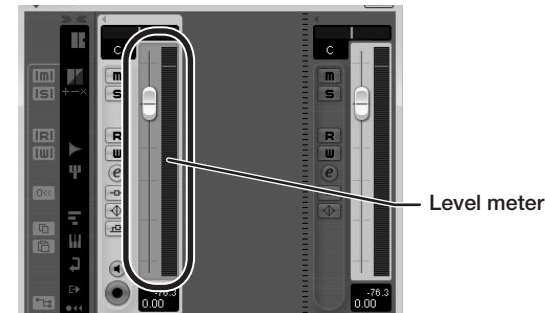

The recording level for Cubase LE 4 can be checked with the level meter for the channel that is assigned to the recording standby track. Set the level as high as possible without causing the meter to reach the end of the scale.

To adjust the level, do not use the fader of Cubase LE 4. Instead change the recording level and gain settings at this unit.

#### NOTE

- While the monitoring button is enabled, the direct signal input to this unit and the signal routed to the computer and then returned to this unit will be output simultaneously from this unit, causing a flanger-like effect in the sound. To accurately monitor the sound also while adjusting the recording level, temporarily set the output device port for the VST connection (step 6) to "Not Connected".
- The level meter as in the above illustration shows the signal level after processing in this unit. When you pluck a guitar string the meter may register with a slight delay, but this is not a defect.

- 15** When the recording level has been adjusted, click the monitoring button to disable it.

The input level is no longer shown on the meter, and the signal returned to this unit via the computer is muted. In this condition, only the signal before sending to the computer can be monitored via the [OUTPUT] jack of this unit.

- 16** Verify that the transport panel is being shown.



If the transport panel is not shown, access the "Transport" menu and select "Transport Panel".

- 17** To start recording, click the Record button in the transport panel.

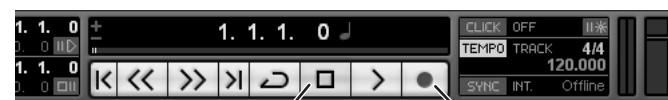

Stop button

Record button

Recording starts.

As you play your instrument, the waveform appears in real time in the project window.

To stop recording, click the Stop button in the transport panel.

- 18** Check the recorded content.

To play the recording, perform the following steps.

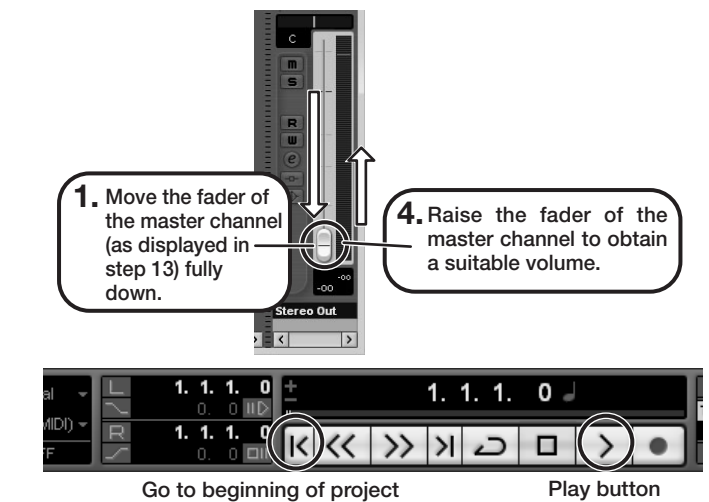

1. Move the fader of the master channel (as displayed in step 13) fully down.

4. Raise the fader of the master channel to obtain a suitable volume.

2. Use the button in the transport panel to move to the beginning of the project.

3. Click the Play button in the transport panel to start playback.

#### HINT

If no sound is heard when you click the Play button after recording, check the VST connection settings (step 6) once more.

#### NOTE

To continue using Cubase LE 4, a process called activation (license authentication and product registration) is necessary. When you start Cubase LE 4, a screen offering to register the product will appear. Select "Register Now". A web site for registration will open in your Internet browser. Follow the instructions on that page to register and activate the product.

#### For optimum enjoyment

While using Cubase LE 4, other applications may slow down drastically or a message such as "Cannot synchronize with USB audio interface" may appear. If this happens frequently, consider taking the following steps to optimize the operation conditions for Cubase LE 4.

- Shut down other applications besides Cubase LE 4. In particular, check for resident software and other utilities.
- Reduce plug-ins (effects, instruments) used by Cubase LE 4. When there is a high number of plug-ins, the computer's processing power may not be able to keep up. Reducing the number of tracks for simultaneous playback can also be helpful.
- Power the unit from an AC adapter. When a device designed to use USB power is powered via the USB port, the current supply may sometimes fluctuate, leading to problems. See if using an AC adapter improves operation.

If applications still run very slowly or the computer itself does not function properly, disconnect this unit from the computer and shut down Cubase LE 4. Then reconnect the USB cable and start Cubase LE 4 again.