

**ZOOM**®

# **F4** MultiTrack Field Recorder

Version 3.0 Supplementary Manual

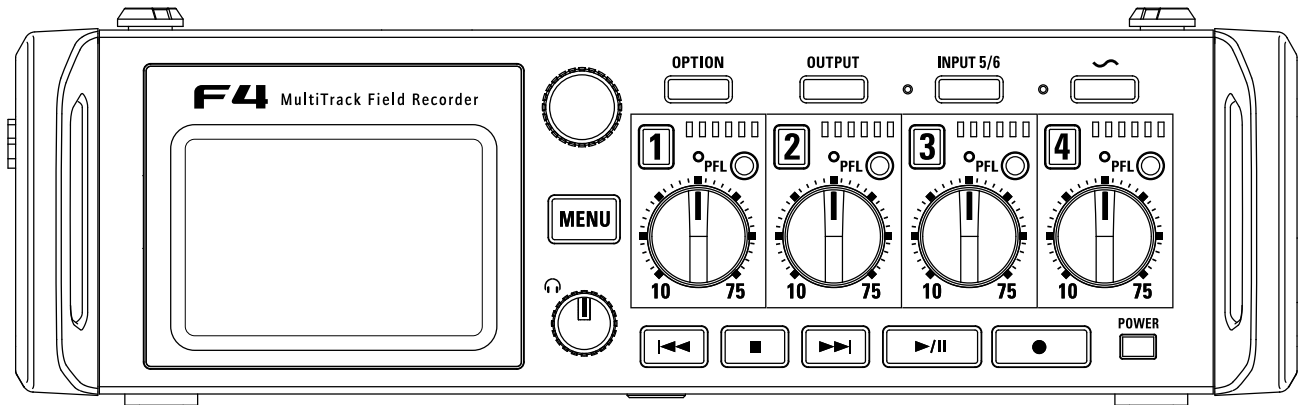

© 2019 ZOOM CORPORATION

Copying or reprinting this manual in part or in whole without permission is prohibited.

# Contents

## Functions added in Version 3.0

Monitoring the input signals of specific tracks (PFL/SOLO) . . . . .	03
Setting the input source (Input Source). . . . .	04
Input limiter . . . . .	05
Changing the automatic mixing setting (Auto Mix) . . . . .	11
Boosting headphone output to alleviate interference from recorded sound (HP Digital Boost) . . . . .	12
Setting signals sent to the output jacks (Routing) . . . . .	13
Correcting timecode errors after the power has been turned off . . . . .	17
Using SD card recording and audio interface functions at the same time (AIF with Rec). . . . .	19

## Appendix

Detailed product diagrams . . . . .	21
-------------------------------------	----

## Monitoring the input signals of specific tracks (PFL/SOLO)

In Version 3.0, setting the input source was added. You can monitor the input signals of specified tracks. Even tracks that have not been set to record can be input to the PFL screen and their input sounds monitored. This is convenient when using tracks as return inputs. You can also make various settings for these tracks.

### 1. Press PFL on the tracks that you want to monitor.

The selected track keys will light orange, and the PFL screen will open.

"PFL" or "SOLO" appears at the top of the display, and you will be able to monitor the input signal with headphones.

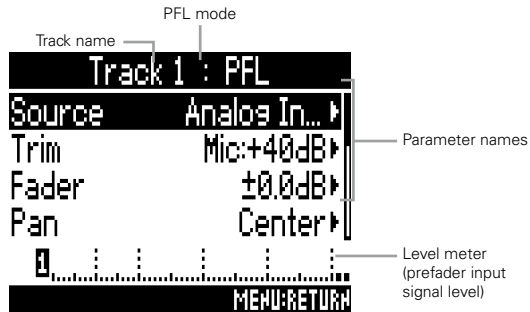

Parameter	Explanation
Source	This sets the input source. (→ P4 )
Trim	This sets the input level.
Fader	This sets the fader level.
Pan	This sets the panning.
Phantom	This sets phantom power.

Parameter	Explanation
HPF	This sets the high pass filter.
Input Limiter	This sets the limiter.
Phase Invert	This sets the phase.
Input Delay	This sets the input delay.
Stereo Link	This sets the stereo link.
PFL Mode	This sets the monitoring volume on the PFL screen.

#### NOTE

This does not change the signals output from MAIN OUT and SUB OUT.

#### HINT

Use  to select parameters and change setting values.



### 2. Press PFL or for the monitored tracks.

Open the Home Screen.



## Setting the input source (Input Source)

Follow these procedures to set the input source of each track.



1. Press .

2. Use  to select INPUT, and press .

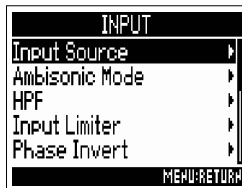

3. Use  to select Input Source, and press .



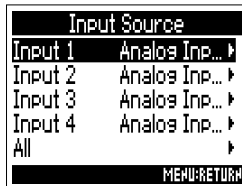

4. Use  to select a track, and press .



### HINT

Select ALL to set all the tracks at the same time.

5. Use  to select the input source, and press .

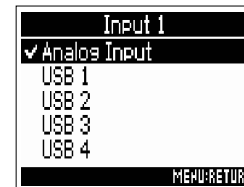

Setting value	Explanation
Analog Input	This treats signals input through INPUT 1–4 as input signals.
USB 1, USB 2, USB 3, USB 4	When AIF with Rec (→ P.19) is set to On, computer output signals are treated as input signals.

### NOTE

- The Input Source cannot be changed for Inputs 5 and 6.
- When dual channel recording is enabled the Input Source cannot be changed for the dual channel recording tracks.

## Input limiter

In Version 3.0, advanced limiter was added. The limiter can prevent distortion by controlling input signals that have excessively high levels.

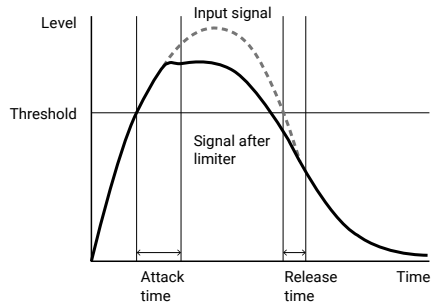

When the limiter is ON, if the input signal level exceeds the set threshold value, the signal level will be suppressed to prevent the sound from distorting.

The amount of time after the input signal exceeds the threshold until compression of the output signal is maximized is called the “attack time”. The amount of time after the input signal goes below the threshold until the limiter stops compressing the signal is called the “release time”. You can change these two parameters to adjust the sound quality.

### HINT

The **F4** has a newly designed limiter that provides 10 dB of headroom, allowing signals to be kept well below the set threshold, therefore more effectively preventing distortion.

1. Press .

2. Use to select INPUT,  
and press .



3. Use to select Input  
Limiter, and press .

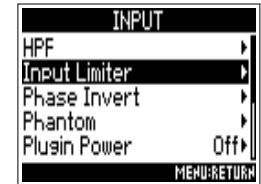

4. Use to select the input,  
and press .

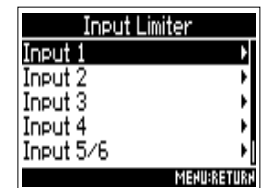

### HINT

Select ALL to set all the inputs at the same time.

## Input limiter (continued)

▶ Continue to one of the following procedures.

Using the limiter.....	P.06
Setting the type .....	P.07
Setting the threshold.....	P.08
Setting the attack time.....	P.08
Setting the release time .....	P.09
Setting the target level.....	P.10

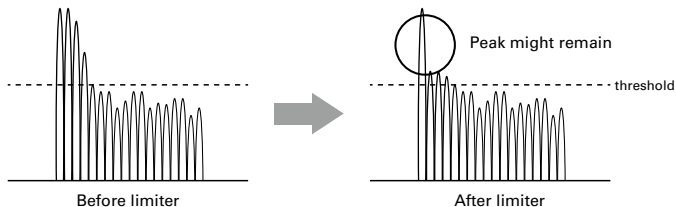

### On (Normal)



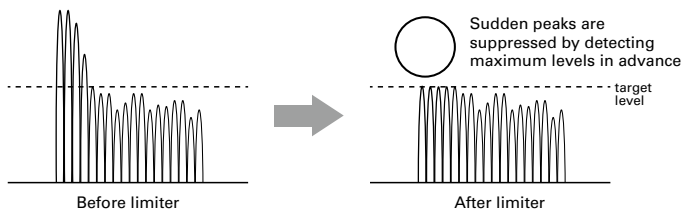

### On (Advanced)



## Using the limiter

5. Use  to select On/Off, and press .



6. Use  to select the setting, and press .

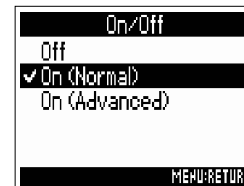

Setting value	Explanation
Off	This disables the limiter.
On (Normal)	This applies an ordinary limiter. The ratio is 20:1.
On (Advanced)	By detecting the maximum level in advance, this optimized limiter prevents distortion even more than ordinary limiter operation. The ratio is ∞:1, providing increased internal headroom.



### NOTE

When set to On (Advanced), the input latency of the **F4** increases 1 ms. When monitoring sounds being recorded with a mic in real-time, increased latency can cause interference between sound transmitted through the air from the source and the delayed monitored sound, possibly making accurate monitoring of the sounds difficult.



**NOTE**

- When set to On (Advanced), the Sample Rate cannot be set to 192 kHz. Moreover, when the Sample Rate is set to 192 kHz, the On (Advanced) setting cannot be selected.

**Setting the type**

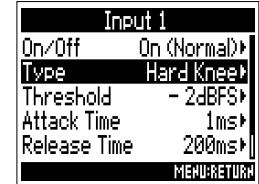
- 5.** Use  to select Type,  
and press .



- 6.** Use  to select the type,  
and press .



Setting value	Explanation
Hard Knee	Only peaks that exceed the threshold are attenuated. There is no effect below the threshold.
Soft Knee	The limiter gradually affects the signal about 6 dB below the threshold for a gentler effect.



**NOTE**

This setting can be made when On/Off is set to On (Normal).



## Input limiter (continued)

### Setting the threshold

This sets the level at which the limiter begins operating.

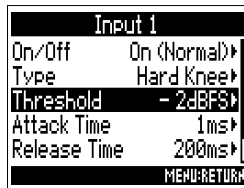
- 5.** Use  to select Threshold, and press .



- 6.** Use  to adjust the setting, and press .



#### HINT



This can be set from -16 to -2 dBFS.

#### NOTE

This setting can be made when On/Off is set to On (Normal).

### Setting the attack time

This sets the amount of time until limiting starts after the input signal exceeds the threshold.

- 5.** Use  to select Attack Time, and press .



- 6.** Use  to adjust the time, and press .



#### HINT

This can be set from 1 to 4 ms.

#### NOTE

This setting can be made when On/Off is set to On (Normal).



## Setting the release time

This sets the amount of time until limiting stops after the input signal goes below the threshold.

5. Use  to select Release

Time, and press .

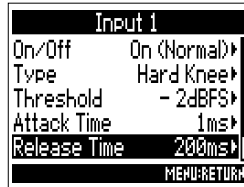

6. Use  to adjust the time,  
and press .



### HINT

- Limiter operation is linked for tracks that have stereo link or MS stereo link enabled. If the signal for either linked channel reaches the threshold, the limiter will operate on both tracks.
- When the limiter is operating, the right-most segment of the level meter and the mixer limiter indicator on the display light.



### NOTE

This setting can be made when On/Off is set to On (Normal).

## Input limiter (continued)

### Setting the target level

When the limiter On/Off setting is set to On (Advanced), use this to set the target output level for the signal.

- 5.** Use  to select Target Level, and press .



- 6.** Use  to adjust the setting, and press .



#### HINT

- This can be set from -16 to 0 dBFS.
- After a signal passes through the limiter, it will not exceed the set target level value.

#### NOTE



This setting becomes available when On/Off is set to On (Advanced).

## Changing the automatic mixing setting (Auto Mix)

When using multiple mics to capture audio during a meeting, for example, automatically attenuating the inputs of mics that are not in active use provides the following benefits.

- The likelihood of feedback is reduced.
- Background noise, including fans and crowds is suppressed to a certain level regardless of the number of people using mics.
- Sound quality degradation due to phase differences caused by variations in the distances of multiple mics is reduced.

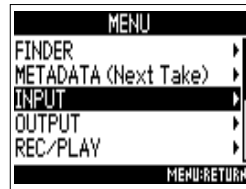

1. Press .

2. Use  to select INPUT, and press .



3. Use  to select Auto Mix, and press .



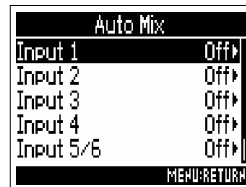

4. Use  to select a track, and press .



### HINT

Select ALL to set all the tracks at the same time.

5. Use  to select On, and press .



### NOTE

- The following functions and settings cannot be used with this function.
  - The sampling rate cannot be set to 192 kHz.
  - The Ambisonic Mode format cannot be set to any value other than Off.
- When the sampling rate is set to 44.1–48.048 kHz and Auto Mix is set to On, the **F4** latency will increase 2 ms.
- When monitoring sounds being recorded with a mic in real-time, increased latency can cause interference between sound transmitted through the air from the source and the delayed monitored sound, possibly making accurate monitoring of the sounds difficult.



## Boosting headphone output to alleviate interference from recorded sound (HP Digital Boost)

You can set the type of signal sent to the headphone output, MAIN OUT and SUB OUT to either prefader or postfader for each track.

1. Press .

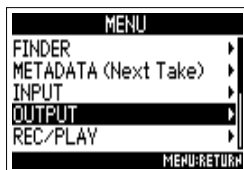
2. Use  to select OUTPUT, and press .



3. Use  to select HP Digital Boost, and press .

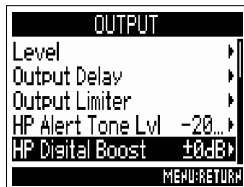

4. Use  to adjust the amount of boost, and press



### HINT

The amount of boost can be set from 0 to +24 dB.

### NOTE

- In situations where the sound being recorded can be heard at the headphone monitoring position, sound waves traveling through the air can interfere with the sound heard from the headphones, altering the monitored sound. The more the sound heard through the headphones is delayed and the lower its volume, the greater the impact of the sound waves.
- HP Digital Boost adds a set boost volume to the adjusted headphone volume level, reducing the impact of the sound waves that travel through the air.

## Setting signals sent to the output jacks (Routing)

In Version 3.0, advanced limiter was added. You can set the type of signal sent to the headphone output, MAIN OUT and SUB OUT to either prefader or postfader for each track.

1. Press .

2. Use  to select OUTPUT, and press .

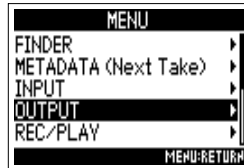

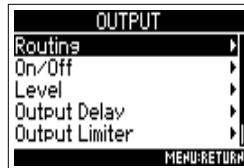

3. Use  to select Routing, and press .





► Continue to one of the following procedures.

Setting signals sent to the headphone output.....	P.13
Setting signals sent to the MAIN OUT.....	P.15
Setting signals sent to the SUB OUT.....	P.16

### Setting signals sent to the headphone output

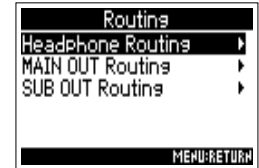
4. Use  to select Headphone Routing, and press .



5. Use  to select the tracks/outputs for routing, and press .

A screenshot of the Headphone Routing screen. It shows a grid of track routing options for 12 tracks (1-12, L, R, M1, 2, S1, 2). Below the grid are checkboxes for MS (Mid-side stereo monitoring), MONO MIX, PRE (Prefader selected), POST (Postfader selected), and ALL CLEAR (Clear all settings). A legend on the right explains the checkboxes: Prefader selected (checked), Postfader selected (checked), and Off (unchecked). Arrows point from the legend to the corresponding checkboxes on the screen.

Press to cycle through settings

- Change tracks 1-6 to postfader (cancel others)
- Change L/R to postfader (cancel others)
- Change M1/M2 to postfader (cancel others)
- Change S1/S2 to postfader (cancel others) (cancel MS)
- Change track U1-U4 to postfader (cancel other) (cancel MS)

Press to set tracks 1-6 to prefader (cancel MS)



## Setting signals sent to the output jacks (Routing) (continued)

### NOTE



- You cannot set the L/R, MAIN OUT 1/2, SUB OUT 1/2 or U1-U4 tracks to prefader.
- You cannot select the 1-6, L/R, MAIN OUT 1/2, SUB OUT 1/2 or U1-U4 tracks at the same time. Selecting one will deselect any other.

### HINT

Press  to cycle through the options:  
 Prefader → Postfader → Off.

- 6.** To make the headphone output mono, use  to select **MONO MIX**, and press .



- 7.** To monitor a mid-side stereo signal, use  to select **MS**, and press .



### NOTE

- Mid-side stereo monitoring is disabled for stereo-linked tracks that have Stereo Link Mode set to MS Stereo Link.
- When mid-side stereo monitoring is enabled, the pre-fader tracks will be routed automatically to the headphone channels, with odd to the left and even to the right. In this case, the routing cannot be changed manually.

### HINT

Signals from a mid-side stereo mic can be converted to an ordinary stereo signal for monitoring (MS stereo monitoring).

- 8.** Press .

### Setting signals sent to the MAIN OUT

4. Use to select MAIN OUT Routing, and press .

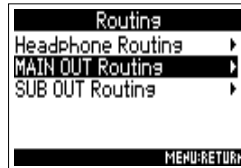

5. Use to select the track for MAIN OUT 1 or MAIN OUT 2 routing and press .

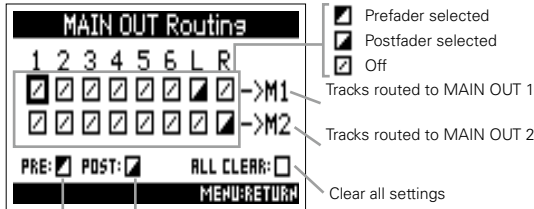

- Prefader selected
- Postfader selected
- Off
- Tracks routed to MAIN OUT 1
- Tracks routed to MAIN OUT 2
- Clear all settings

- Press to cycle through settings
- Change tracks 1–6 to postfader (cancel others)
  - Change L/R tracks to postfader (cancel others)
  - Change track U1-U4 to postfader (cancel other) (cancel MS)

Press to set tracks 1–6 to prefader

#### HINT

Press to cycle through the options:  
Prefader → Postfader → Off.



#### NOTE

- Tracks 1–6 can be set to Prefader or Postfader.
- L/R tracks and tracks U1-U4 can only be set to Postfader.
- The 1-6, L/R and U1-U4 tracks cannot be selected at the same time. Selecting one type will deselect the other.

6. Press .

## Setting signals sent to the output jacks (Routing) (continued)

### Setting signals sent to the SUB OUT

- 4.** Use  to select SUB OUT Routing, and press .

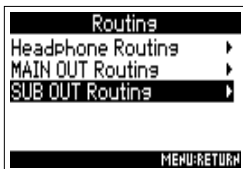

#### NOTE

- Tracks 1–6 can be set to Prefader or Postfader.
- L/R tracks and tracks U1-U4 can only be set to Postfader.
- The 1-6, L/R and U1-U4 tracks cannot be selected at the same time. Selecting one type will deselect the other.

- 5.** Use  to select the track for SUB OUT 1 or SUB OUT 2 routing and press .

The screenshot shows the 'SUB OUT Routing' menu. At the top, it says 'SUB OUT Routing'. Below that are two rows of checkboxes for tracks 1-6, L, and R. The first row is labeled '->S1' and the second row is labeled '->S2'. Below the checkboxes are three options: 'PRE:' with a checked box, 'POST:' with a checked box, and 'ALL CLEAR:' with an unchecked box. At the bottom is a 'MENU:RETURN' button. To the right of the screenshot, there are three legend items: a checked box for 'Prefader selected', a checked box for 'Postfader selected', and an unchecked box for 'Off'. Lines connect these legend items to the corresponding checkboxes in the screenshot. Below the screenshot, there is a list of instructions: 'Press to cycle through settings', 'Change tracks 1–6 to postfader (cancel others)', 'Change L/R tracks to postfader (cancel others)', and 'Change track U1-U4 to postfader (cancel other) (cancel MS)'. A line connects the 'ALL CLEAR:' option to the 'Clear all settings' text.

Press again to set tracks 1–6 to prefader

#### HINT

Press  to cycle through the options:  
 Prefader → Postfader → Off.

- 6.** Press .



## Correcting timecode errors after the power has been turned off

When the mode of Start TC is set to RTC, turning the power off lowers the timecode precision, but this function can improve the error to the value close to 0.2 ppm when the power has been turned off.

1. Press .



2. Use  to select TIMECODE (TC), and press .



3. Use  to select Start TC, and press .



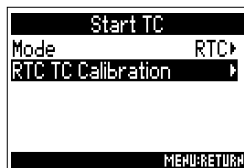

### Setting how timecode is initialized at startup

4. Use  to select RTC TC Calibration, and press .



5. Use  to select Recalib., and press .



6. Use  to select Yes, and press .

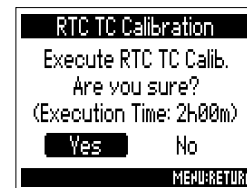

## Correcting timecode errors after the power has been turned off (continued)

### 7. Calibration completes.



### 8. To cancel calibration, press

 and use  to select

Yes, and press .



#### NOTE



- After calibrating once, the result will be retained.
- If the **F4** is moved to and used in an extremely hot or cold location, timecode precision could change slightly when the power is turned off. In such cases, we recommend calibrating it again.
- Calibration is not possible when AIF with Rec is set to On.
- Calibration is only possible when StartTC mode is set to RTC.
- Calibration is not possible when an **FRC-8** is connected.

## Using SD card recording and audio interface functions at the same time (AIF with Rec)

In addition to the two SD cards, a computer can also be used for recording backup.

### Connecting

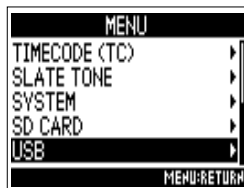

1. Press .

2. Use  to select USB, and press .



3. Use  to select AIF with Rec, and press .



4. Use  to select On, and press .



5. Use a USB cable to connect the **F4** and the computer.



## Using SD card recording and audio interface functions at the same time (AIF with Rec) (continued)

### NOTE

- The **F4** cannot operate on USB bus power. Use the internal batteries, the dedicated AC adapter or an external DC power supply to power it.
- AIF with Rec cannot be used with the following settings and functions.
  - Sampling rate settings other than 44.1/48 kHz
  - The format of Ambisonic Mode other than Off, FuMa, AmbiX, and Ambisonics A.
  - SD Card Reader
  - Audio Interface
- **FRC-8**
- A driver is necessary for use with Windows. Download the driver from the ZOOM website ([www.zoom.co.jp/](http://www.zoom.co.jp/)). Driver not required for Mac.
- When AIF with Rec is set to On, the sampling rate cannot be changed.
- When AIF with Rec is set to On, files with sampling rates that differ from the **F4** setting cannot be played.
- Set the input source to USB1-4 (→P4) or set USB1-4 to the output routing (→P13) to monitor sound played back from the computer.
- When AIF with Rec is set to On, the **F4** latency will increase 2 ms. When monitoring sounds being recorded with a mic in real-time, increased latency can cause interference between sound transmitted through the air from the source and the delayed monitored sound, possibly making accurate monitoring of the sounds difficult.

### Disconnecting

1. Press .

2. Use  to select Off, and press .



3. Disconnect the cable from the computer and the **F4**.

### NOTE

Specification of AIF with Rec

- Class: USB2.0 High Speed
- Sampling rate: 44.1/48 kHz
- Bit rate: 16/24-bit
- 8IN/4OUT

# Detailed product diagrams

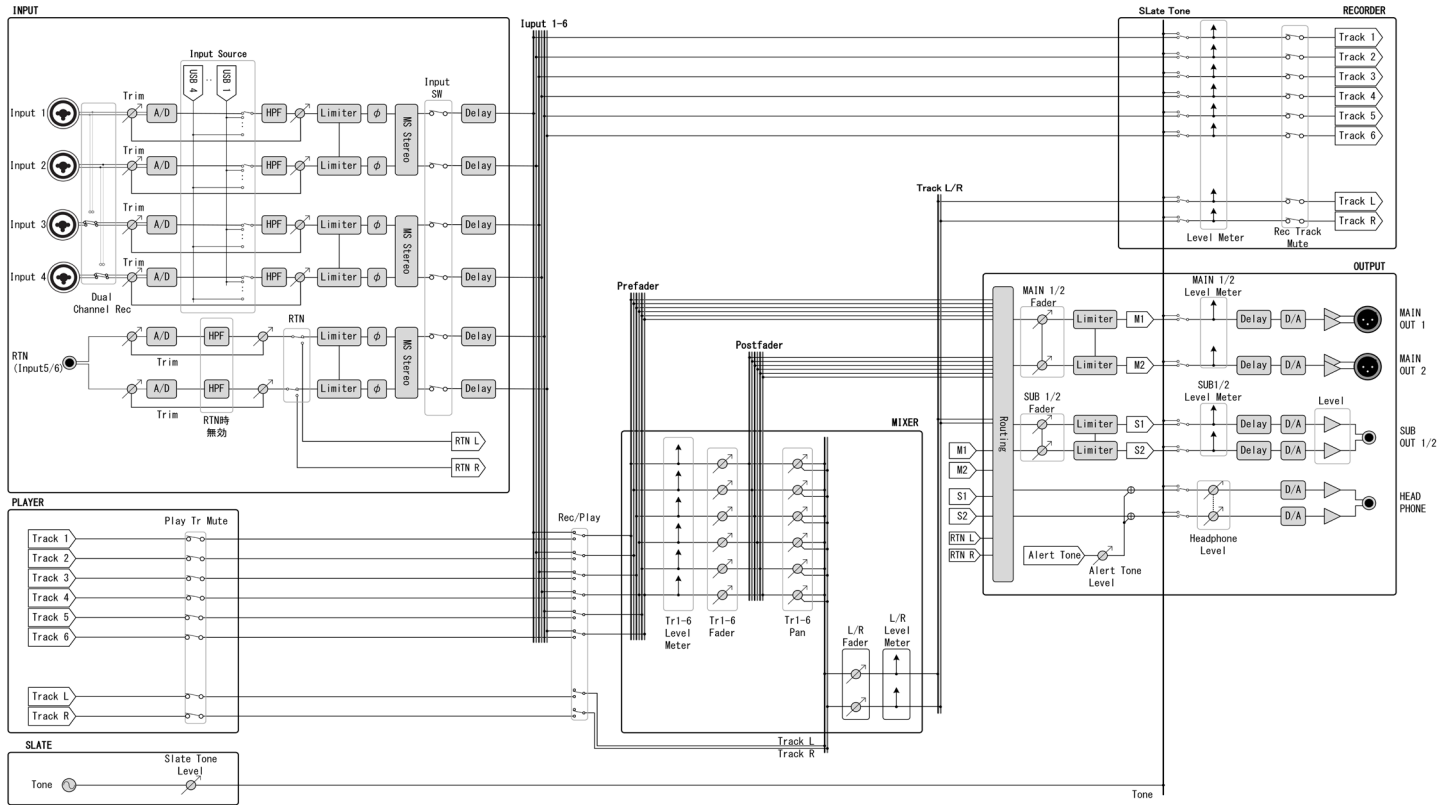

# Detailed product diagrams (continued)

## Routing

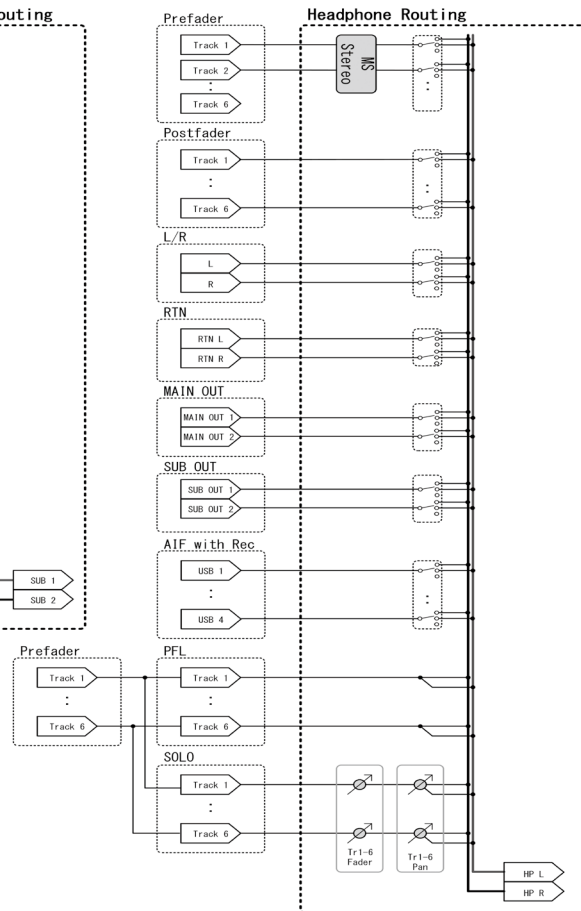
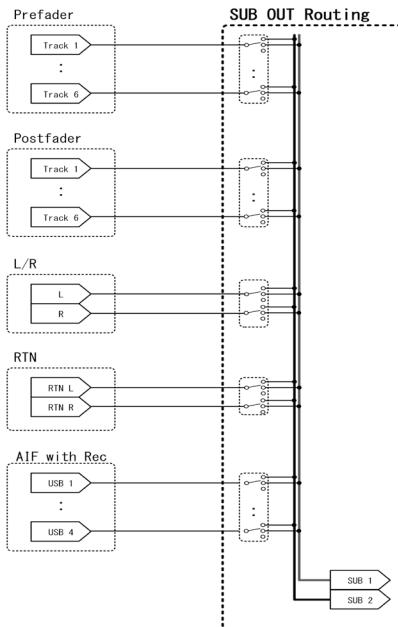
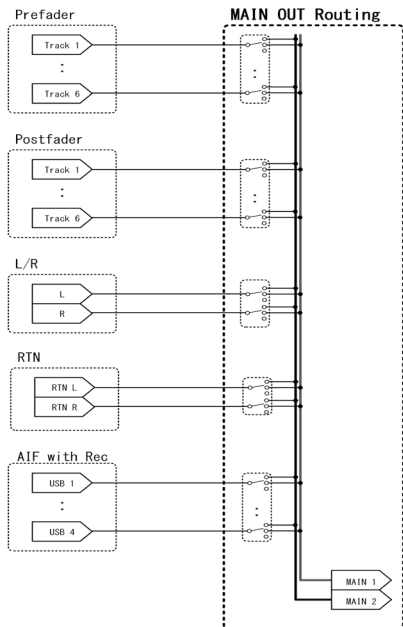



ZOOM CORPORATION

4-4-3 Kanda-surugadai, Chiyoda-ku, Tokyo 101-0062 Japan

<http://www.zoom.co.jp>