

# B2 FOUR

## EFFECTS & AMP EMULATOR

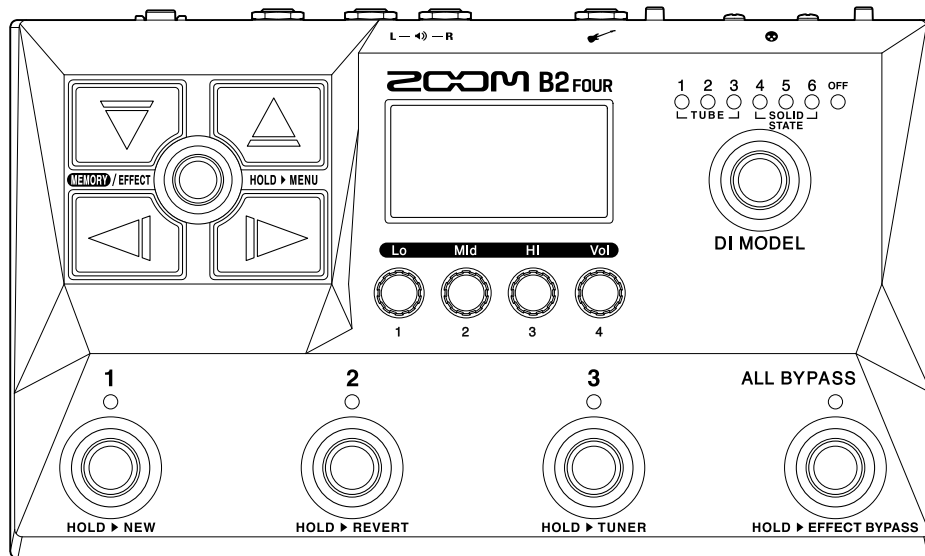

## Operation Manual

You must read the Usage and Safety Precautions before use.

©2023 ZOOM CORPORATION

Copying or reprinting this manual in part or in whole without permission is prohibited.

Product names, registered trademarks and company names in this document are the property of their respective companies. All trademarks and registered trademarks in this document are for identification purposes only and are not intended to infringe on the copyrights of their respective owners.

Proper display is not possible on grayscale devices.

# Notes about this Operation Manual

---

You might need this manual in the future. Always keep it in a place where you can access it easily. The contents of this document and the specifications of the product could be changed without notice.

- Microsoft and Windows are trademarks of the Microsoft group of companies.
- iPadOS, Lightning and Mac are trademarks of Apple Inc.
- App Store is a service mark of Apple Inc.
- iOS is a trademark or registered trademark of Cisco Systems, Inc. in the USA and other countries, and it is used under license.
- Android is a trademark of Google LLC.
- USB Type-C is a trademark of the USB Implementers Forum.
- Other product names, registered trademarks and company names in this document are the property of their respective companies.
- All trademarks and registered trademarks in this document are for identification purposes only and are not intended to infringe on the copyrights of their respective owners.
- The illustrations and display screens in this document could differ from the actual product.

# Terms used in this manual

---

## Patch memory

Patch memories store effects and amps used, effect on/off states and parameter setting values, allowing easy recall. Effects are saved and recalled in units of patch memories. Up to 5 effects can be added to a patch memory, and up to 300 patch memories can be stored.

## Effect type

The available effect types include various bass effects and amp/cabinet simulation models. Effects can be selected from these types to be added to patch memories.

## Category

Effects are grouped by types into categories.

## Autosave

This function automatically saves changes to patch memory and effect settings.

## ECO mode

This function will automatically turn the power off 10 hours after the last operation.

## Looper

Mono phrases that are up to 60 seconds long can be recorded and played back repeatedly. This can be synchronized with rhythm patterns.

## Preselect

This function allows continued use of the current patch memory sound while switching to another patch memory at a distant number.

# Contents

---

Notes about this Operation Manual.....	2
Terms used in this manual.....	3
B2 FOUR structure.....	6
Signal flow.....	6
Memory overview (patch memories).....	8
Functions of parts.....	9
Top.....	9
Back.....	10
Side.....	11
Screens that appear on the display.....	12
MEMORY Screen.....	12
EFFECT Screen.....	13
Library Screen.....	14
MENU Screen.....	15
Making connections.....	18
Turning the power on/off.....	20
Turning the power on.....	20
Turning the power off.....	20
Selecting the DI MODEL.....	21
Using the bypass function.....	22
Adjusting the overall tonal character and output level.....	23
Switching patch memories while playing (MEMORY Screen).....	24
Using the PRESELECT function.....	26
Turning the PRESELECT function on/off.....	26
Selecting patch memories when the PRESELECT function is on.....	28
Editing effects (EFFECT Screen).....	30
Opening the EFFECT Screen.....	30
Turning effects on/off.....	32
Replacing effects.....	34
Adjusting effect parameters.....	37
Changing the order of effects.....	39
Adjusting the tempo.....	41
Managing patch memories.....	43
Changing patch memory names.....	43
Copying and saving patch memories.....	45
Deleting patch memories.....	47
Creating patch memories.....	49
Reverting patch memory changes.....	50
Using the tuner.....	52
Activating the tuner.....	52

Changing tuner settings.....	53
Using a connected expression pedal.....	56
Setting pedal effects.....	56
Using rhythms.....	58
Setting the rhythm effect.....	58
Starting/stopping rhythm playback.....	60
Rhythm patterns.....	61
Using the looper while playing.....	62
Setting the looper effect.....	62
Looper operations.....	69
Using audio interface functions.....	74
Installing drivers.....	74
Connecting with a computer, smartphone or tablet.....	75
Operating the B2 FOUR from an iPhone/iPad.....	76
Making hardware settings.....	77
Setting the AUTO SAVE function.....	77
Setting the ECO mode.....	79
Adjusting the display contrast.....	80
Managing the firmware.....	81
Checking the firmware versions.....	81
Updating.....	81
Restoring factory default settings.....	82
Appendix.....	83
Troubleshooting.....	83
Specifications.....	84

# B2 FOUR structure

## Signal flow

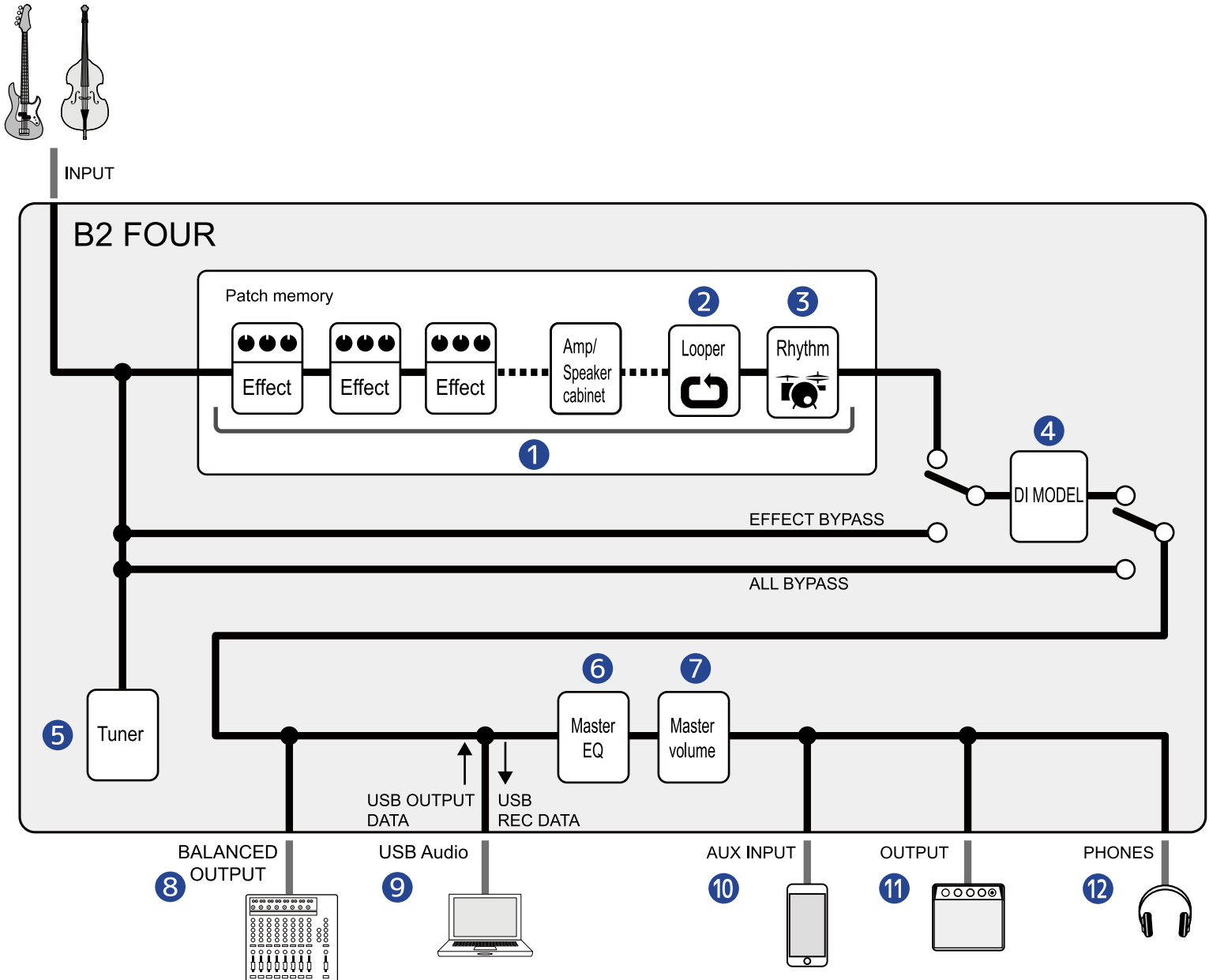

### 1 Patch memory

The input bass sound passes through effects, followed by amp and speaker cabinet models, in order. (→ [Adjusting effect parameters](#))

### 2 Looper

Recorded loops can be played back. (→ [Using the looper while playing](#))

### 3 Rhythm

Drum sounds can be played back using internal rhythm patterns. (→ [Using rhythms](#))

- 4 DI MODEL**  
DI models that emulate the characteristics of tube and solid-state types can be selected. (→ [Selecting the DI MODEL](#))
- 5 Tuner**  
This can be used to tune connected basses. (→ [Using the tuner](#))
- 6 Master EQ**  
This adjusts the overall tonal character. This setting is retained even when the patch memory is changed. (→ [Adjusting the overall tonal character and output level](#))
- 7 Master volume**  
This adjusts the overall volume. This setting is retained even when the patch memory is changed. (→ [Adjusting the overall tonal character and output level](#))
- 8 Balanced output**  
This is output from the BALANCED OUTPUT jack. Connect this to a PA mixer, for example.
- 9 USB audio**  
Audio data can be exchanged with computers and smartphones using the audio interface function. (→ [Using audio interface functions](#))
- 10 AUX INPUT**  
Audio can be played back from a smartphone, portable audio player or other device.
- 11 OUTPUT**  
An amp or powered monitors can be connected.
- 12 PHONES**  
Headphones can also be connected.

# Memory overview (patch memories)

## Patch memories

These store the effects used, their order, on/off states and parameter settings. Effects can be saved and recalled in patch memory units. 300 patch memories can be stored.

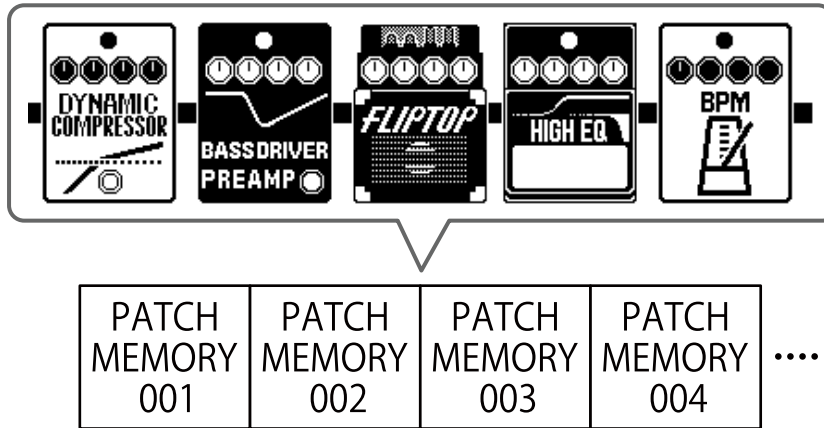



# Functions of parts

## Top

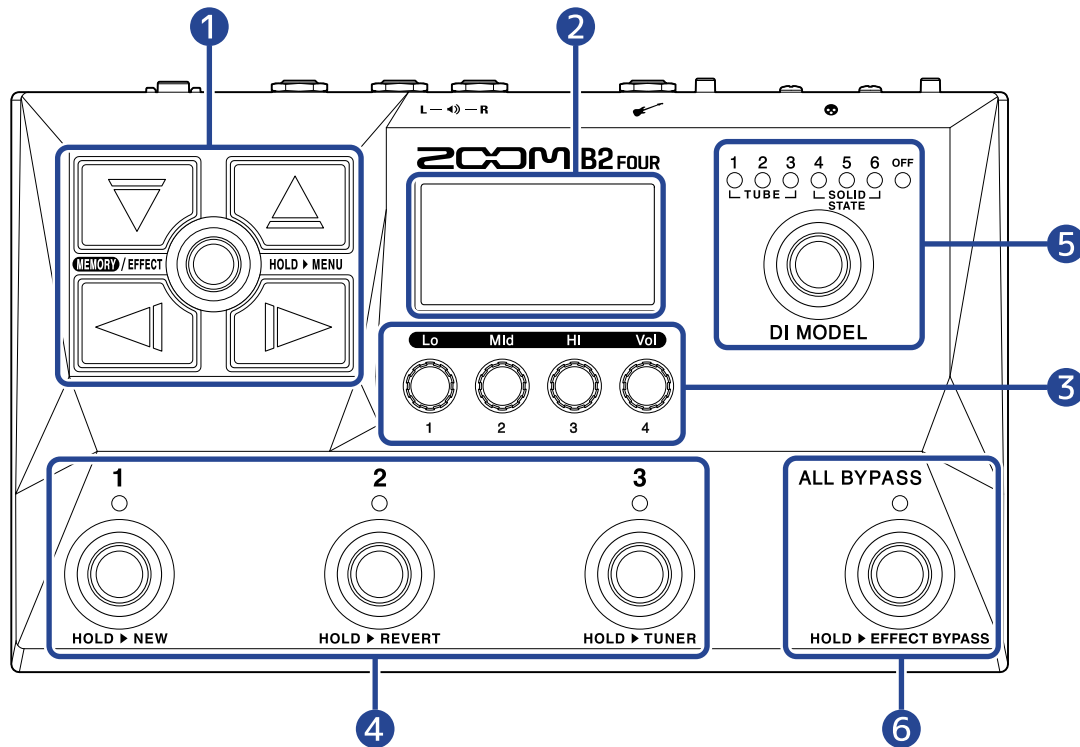

### 1 Direction buttons

Use these to select patch memories and effects, for example. They can be operated by foot.

### 2 Display

This shows information, including the names of the selected patch memory and its effects along with their parameter values.

### 3 Parameter knobs

Use these to adjust effect parameters and make various settings.

### 4 Footswitches/indicators

Use these to select patch memories and turn effects on/off. When the [EFFECT Screen](#) is open, the indicators show whether effects are on or off.

### 5 DI MODEL switch

Use this to select the DI MODEL. (The selected model lights.)

### 6 Bypass switch

This turns bypassing on/off.

# Back

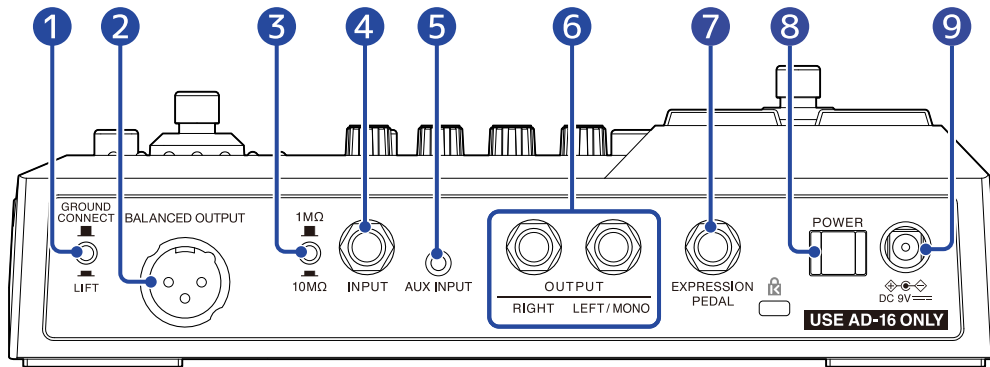

## 1 GROUND CONNECT/LIFT switch

The BALANCED OUTPUT jack can be connected or disconnected from the ground.

## 2 BALANCED OUTPUT jack

Connect this to a PA system.

## 3 Impedance selection switch

Set the impedance to suit the connected bass.

## 4 INPUT jack

Connect a bass to this.

## 5 AUX INPUT jack

Connect a portable music player or similar device here.

## 6 OUTPUT jacks

Connect a bass amp or powered monitors here.

## 7 EXPRESSION PEDAL jack

Connect an expression pedal (ZOOM FP02M) here, and use it to adjust a pedal effect.

## 8 POWER switch

This turns the power on/off.

## 9 DC 9V AC adapter connector

Connect the dedicated AC adapter (ZOOM AD-16) here.

# Side

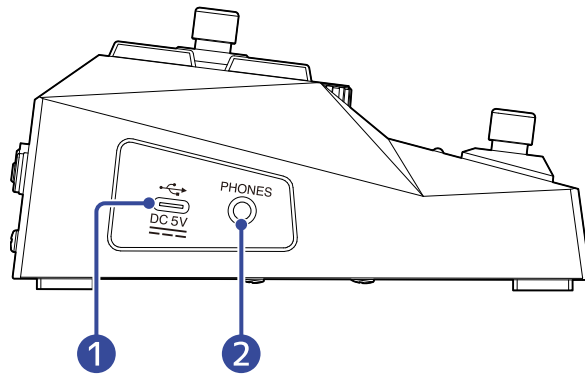

## 1 USB (Type-C) port

Connected to a computer, smartphone or tablet, this can be used as an audio interface.

In addition, Handy Guitar Lab can be used to manage patch memories and edit and add effects, for example, from a smartphone or tablet.

This supports operation on USB bus power.

## 2 PHONES output jack

Connect headphones here.

---

### **HINT:**

Handy Guitar Lab for B2 FOUR can be downloaded from the App Store.

---

# Screens that appear on the display

The B2 FOUR is operated with buttons and knobs while viewing the display. This section explains the screens shown on the display.



## MEMORY Screen





This opens when the power is turned on.

This shows patch memories, allowing them to be selected for performing and editing.



### 1 Patch memory numbers

Footswitches  -  can be used to select the patch memories that are shown currently.



Use  /  to select a patch memory one lower or higher. Use  /  to select a patch memory 10 places away.

The selected patch memory is highlighted.

### 2 Patch memory name

This shows the name of the selected patch memory.

## Opening the MEMORY Screen

- When the [MENU Screen](#) or [EFFECT Screen](#) is open: Press .
- When the [Library Screen](#) is open: Confirm the selected effect to open the [EFFECT Screen](#), and press .

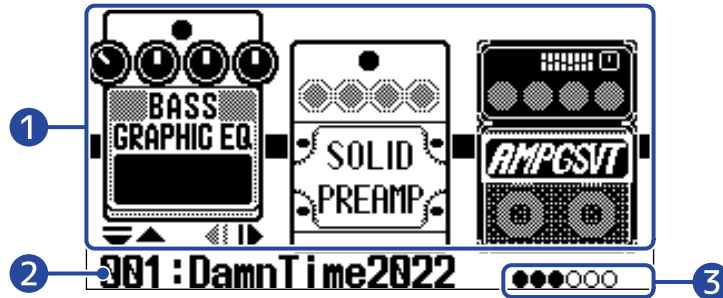

# EFFECT Screen

Patch memories can be edited.



## 1 Effects

This shows the effects in the selected patch memory.

Use  and  to select effects. The selected effect will appear slightly raised.

## 2 Name of current patch memory

## 3 Effects that are being shown

Up to 3 effects can be shown on the display. The black circles indicate the positions of the effects that are being shown.

## Opening the EFFECT Screen

- When the [MEMORY Screen](#) or [MENU Screen](#) is open: Press .
- When the [Library Screen](#) is open: Press  to confirm the selected effect.

# Library Screen

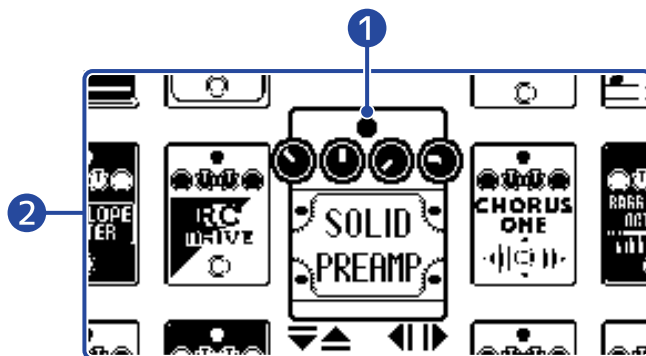

Effects in patch memories can be changed.





## 1 Selected effect

The selected effect is shown larger and in the center.

## 2 Effect list

Effects in the same category are lined up vertically. Use  and  to select effects in the same category.

Use  and  to select effects in different categories.

## Opening the Library Screen

Select the effect to be changed on the [EFFECT Screen](#), and press  or .

## Exiting the Library Screen

Press   to confirm the selected effect and open the [EFFECT Screen](#).

# MENU Screen

Various B2 FOUR settings can be made.

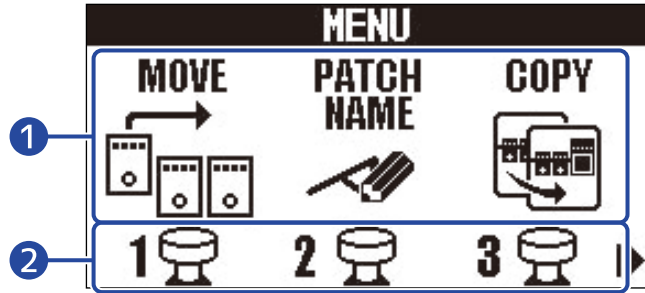

## 1 Setting items

Use and to select the setting items shown with icons.

## 2 Footswitches

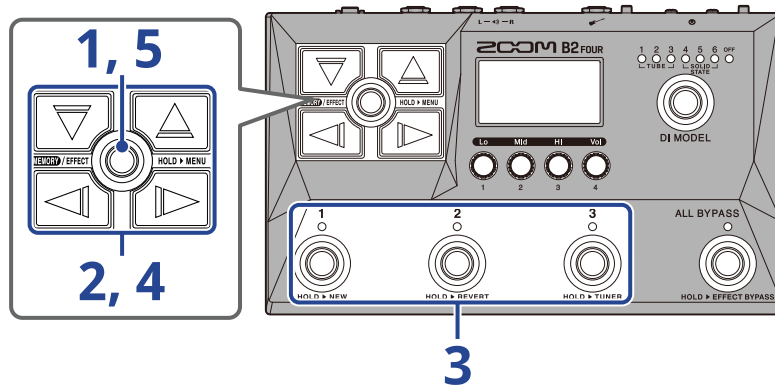

Press footswitches - that correspond to the icons shown on the screen to open their settings screens.

## Using the MENU Screen



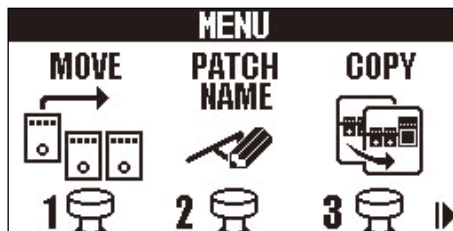









1. Press and hold to open the MENU Screen.



2. Use  and  to show the icon for the desired setting item.

See the reference links for details about each setting.

<p><b>MOVE</b></p>  <p>Change the effect order. (→ <a href="#">Changing the order of effects</a>)</p>	<p><b>PATCH NAME</b></p>  <p>Change the patch memory name. (→ <a href="#">Changing patch memory names</a>)</p>
<p><b>COPY</b></p>  <p>Save and copy patch memories. (→ <a href="#">Copying and saving patch memories</a>)</p>	<p><b>PATCH ERASE</b></p>  <p>Delete patch memories. (→ <a href="#">Deleting patch memories</a>)</p>
<p><b>PRE-SELECT</b></p>  <p>Turn the pre-selection function on/off. (→ <a href="#">Using the PRESELECT function</a>)</p>	<p><b>AUTO SAVE</b></p>  <p>Turn the automatic saving function on/off. (→ <a href="#">Setting the AUTO SAVE function</a>)</p>
<p><b>ALL INIT</b></p>  <p>Restore factory default settings. (→ <a href="#">Restoring factory default settings</a>)</p>	<p><b>ECO</b></p>  <p>Turn the ECO mode on/off. (→ <a href="#">Setting the ECO mode</a>)</p>
<p><b>VERSION</b></p>  <p>Check the firmware versions. (→ <a href="#">Checking the firmware versions</a>)</p>	<p><b>LCD</b></p>  <p>Adjust the display contrast. (→ <a href="#">Adjusting the display contrast</a>)</p>

3. Press a  -  footswitch that corresponds to an icon.

This opens the selected settings screen.

For example, press  when AUTO SAVE is selected.

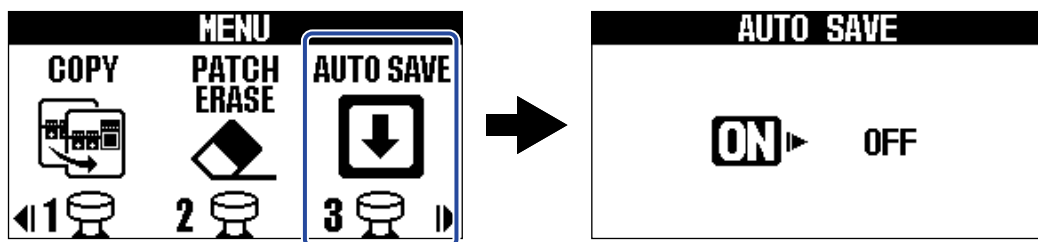



4. Use , ,  and  to select a setting.



5. Press .

This confirms the setting and returns to the [MEMORY Screen](#) or [EFFECT Screen](#).



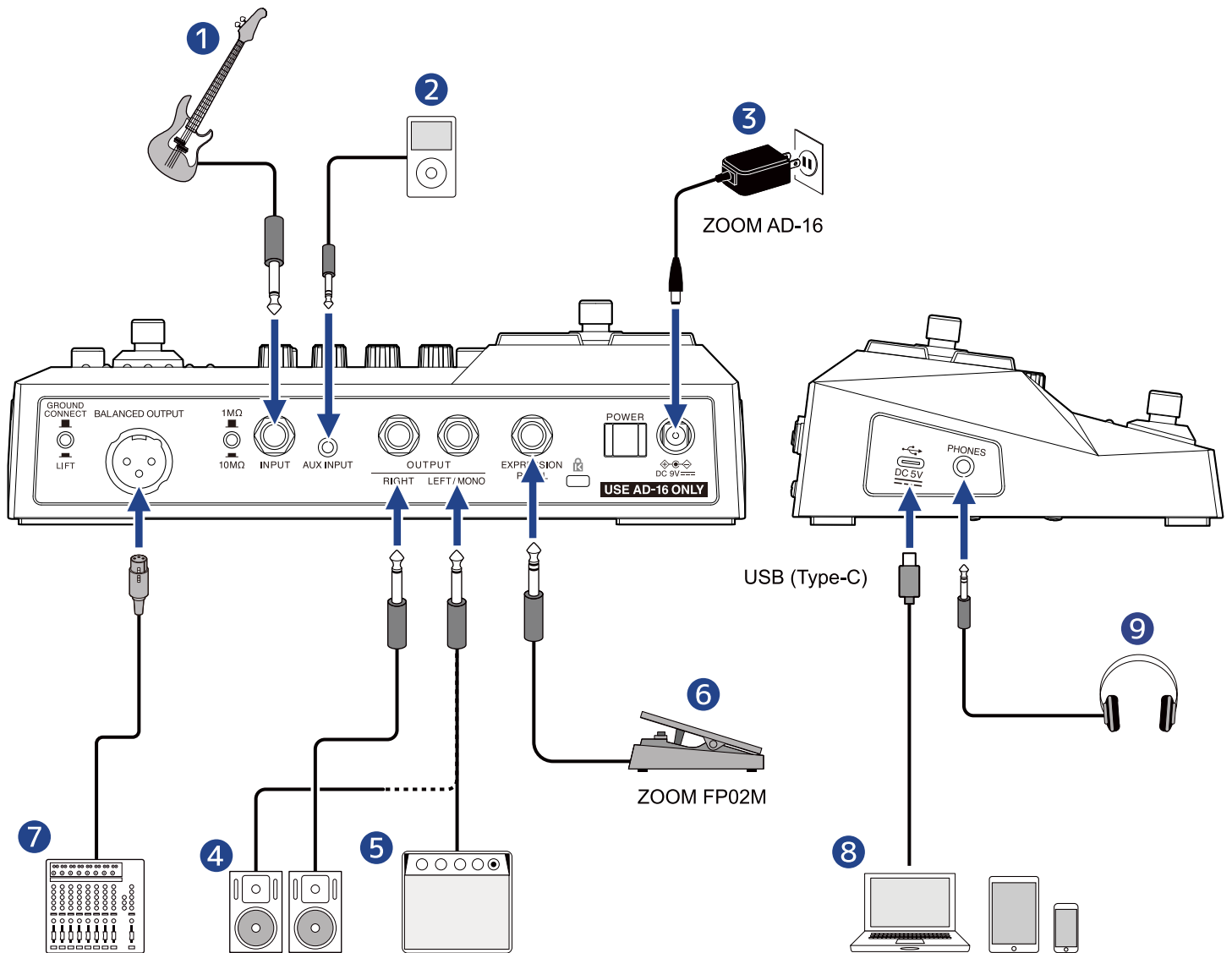

# Making connections



## 1 Bass

Set the impedance selection switch to suit the connected bass.

$1M\Omega$ 	Use this with regular electric basses.
$10M\Omega$ 	Use this with acoustic basses that have piezo pickups.

## 2 Portable music player, etc.

Adjust the volume on the connected device.

## 3 AC adapter (ZOOM AD-16)

## 4 Powered monitors



## 5 Bass amp

## 6 Expression pedal (ZOOM FP02M)

A pedal can be used to control effects.

## 7 PA mixer, etc.

Use  to enabled/disable ground connection for the BALANCED OUTPUT jack.

 CONNECT	This connects the ground pin to the ground.
 LIFT	This disconnects the ground pin from the ground. This is useful if noise is caused by a ground loop.

## 8 Computer (Mac/Windows), smartphone or tablet

Connect with a USB cable (Type-C).

The B2 FOUR can be used as an audio interface and with Handy Guitar Lab.

## 9 Headphones

---

### **HINT:**

The Handy Guitar Lab for B2 FOUR app (iOS/iPadOS) can be used to manage patch memories and to edit and add effects. Handy Guitar Lab for B2 FOUR can be downloaded from the App Store.

---

# Turning the power on/off

## Turning the power on

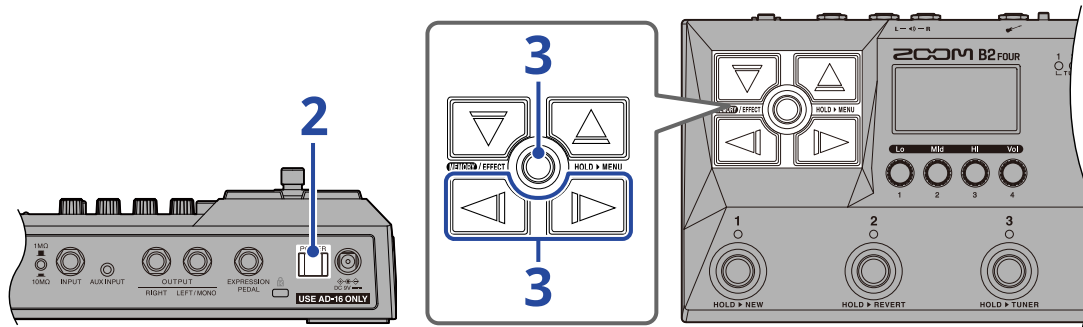

1. Minimize the volume of the amp or powered monitors.

### NOTE:

To prevent noise and malfunction, connect powered monitors and bass amps before turning the power on.

2. Set  to ON.

This turns on the B2 FOUR and opens the MEMORY Screen.

3. Raise the volume of the amp or powered monitors.

### ECO mode overview:

- By default, ECO mode is set to ON, so the power will automatically turn off if no use occurs for 10 hours.
- ECO mode can also be turned OFF. (→ [Setting the ECO mode](#))

## Turning the power off

1. Minimize the volume of the amp or powered monitors.

2. Set  to OFF.

The display will turn off.

# Selecting the DI MODEL

The DI MODEL section of the B2 FOUR has 6 selectable types that reproduce the characteristics of vacuum tube and solid-state DIs.

The DI MODEL affects the output of the BALANCED OUTPUT, OUTPUT and PHONES jacks.

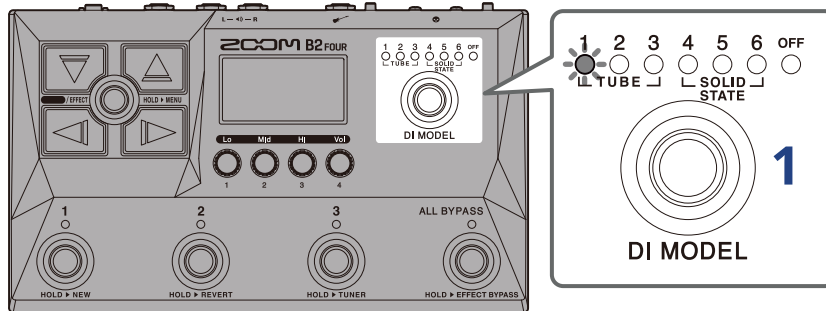

**1.** Press  to select the DI MODEL.

TUBE 1	This models the characteristics of a vacuum tube DI with rich harmonics and thick low frequencies.
TUBE 2	This models the characteristics of a vacuum tube DI with a clear attack and tight low frequencies.
TUBE 3	This models the characteristics of a vacuum tube DI with a clear beautiful sound.
SOLID STATE 1	This models the characteristics of a solid-state DI with moderate compression and a sharp tone.
SOLID STATE 2	This models the characteristics of a solid-state DI with a clear tone and little distortion.
SOLID STATE 3	This models the characteristics of a solid-state DI evocative of the Motown sound.
OFF	This turns off the DI MODEL.

# Using the bypass function

All B2 FOUR effects and the DI MODEL can be bypassed. Bypassing only the effects section is also possible.

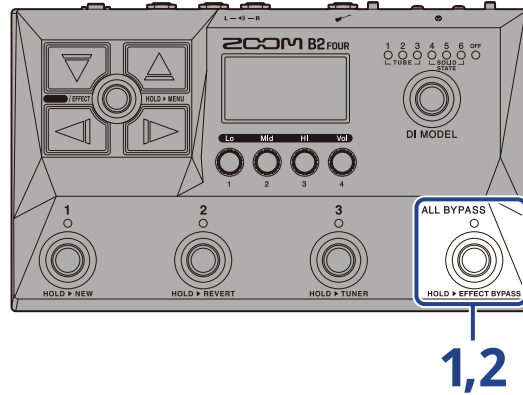

1. Press .

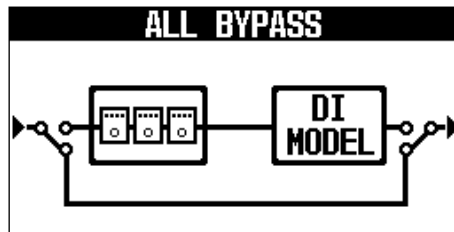

This bypasses the effects section and the DI MODEL.

2. Press and hold .

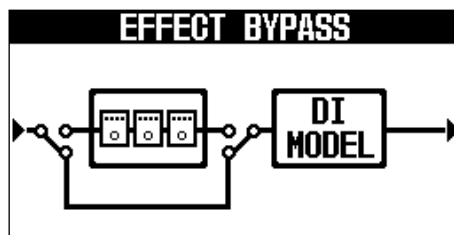

This bypasses the effects section.

ALL BYPASS	This bypasses the effects section and the DI MODEL.
EFX BYPASS	This bypasses the effects section. (Only the DI MODEL is used.)
Unlit	This bypasses nothing.

## HINT:

- Adjusting the EQ and volume of a bass amp, for example, is easier if the B2 FOUR effects are bypassed.
- The bypass function will be off when the power is turned on.

# Adjusting the overall tonal character and output level

The volume and tonal character of sound output from the B2 FOUR can be adjusted. These settings affect the output of the OUTPUT and PHONES jacks.

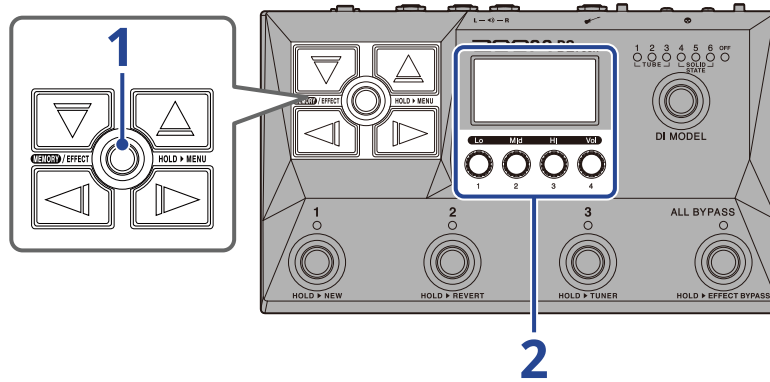

1. Press **MEMORY/EFFECT** to open the [MEMORY Screen](#).



2. Turn  to adjust the EQ and volume of the output sound.

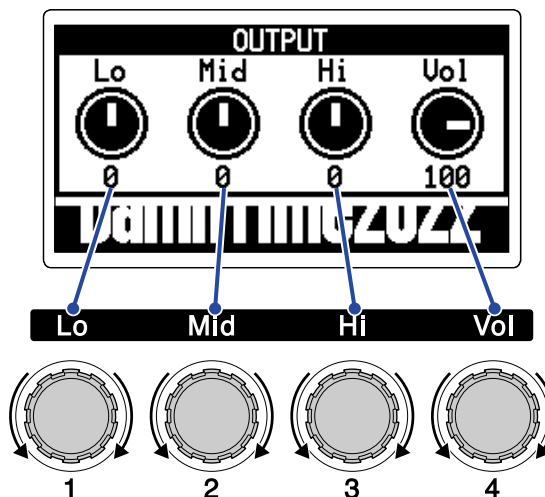

Adjust the low, mid and high range as well as the volume.

After finishing adjustments, the previous screen will reopen after a moment.

# Switching patch memories while playing (MEMORY Screen)

The B2 FOUR manages effects in patch memories. Up to 5 effects can be added to a patch memory, and their on/off states and parameter settings can be saved in it.

On the [MEMORY Screen](#), the patch memory being used can be switched while playing.

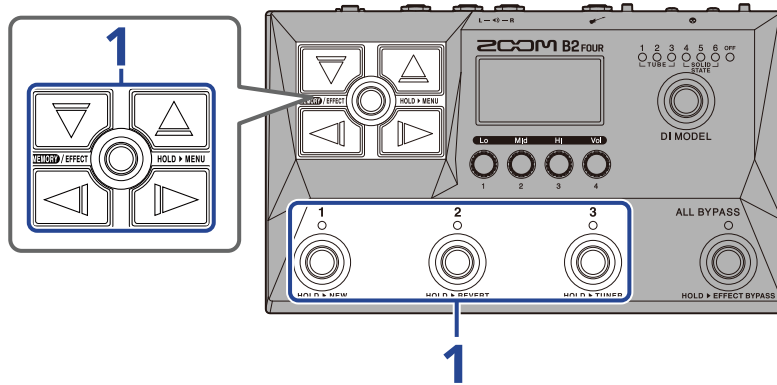

**1.** On the [MEMORY Screen](#), use , ,  and  along with footswitches  -  to select patch memories.

• Use  /  to select a patch memory one lower or higher.

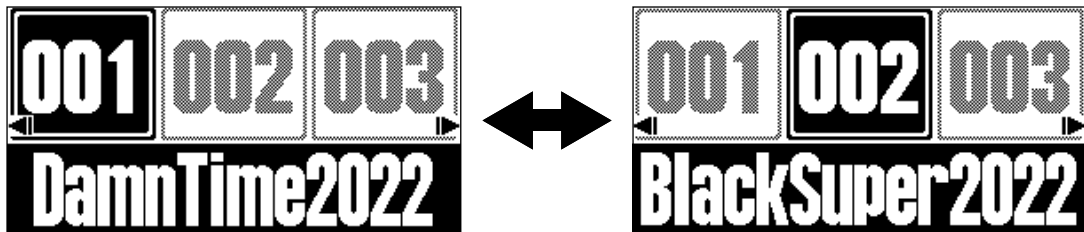

•  /  can be used to select a patch memory 10 places away.

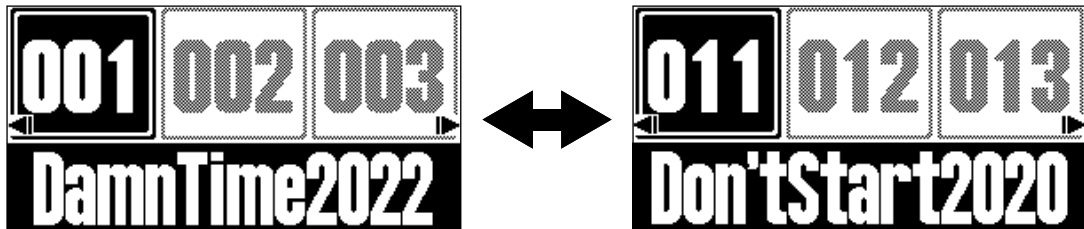



- The patch memories shown on the [MEMORY Screen](#) can be selected directly by pressing footswitches

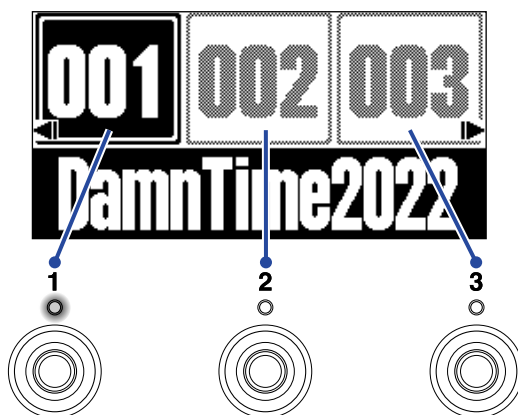

The indicator for the selected patch memory lights.







---

**HINT:**

- Up to 300 patch memories can be created.
  - The PRESELECT function can be used when the [MEMORY Screen](#) is open. This allows the next patch memory to be selected in advance and then switched to with one press. This is useful for switching to patch memories that are not near the current one when performing live. (→ [Using the PRESELECT function](#))
-

# Using the PRESELECT function

The PRESELECT function can be used when the [MEMORY Screen](#) is open.

When the PRESELECT function is ON, using  /  /  /  will put the patch memory change into standby until footswitch  -  is pressed to confirm the change.

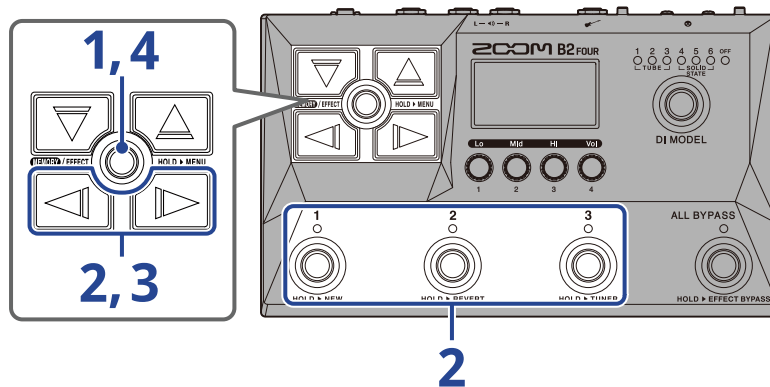

This makes it possible to switch directly to a patch memory that is not near the current one during live performance.

## Turning the PRESELECT function on/off

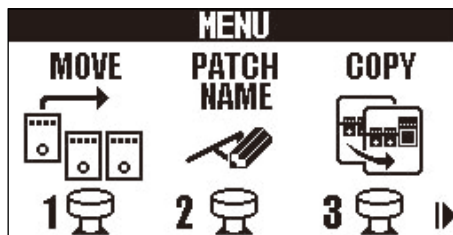

1. Press and hold  to open the [MENU Screen](#).



2. Use  /  to select PRESELECT, and press the corresponding footswitch ( in this example).

This opens the Preselect Screen.

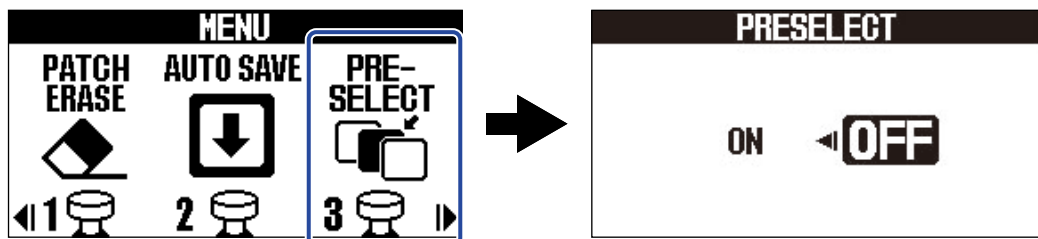

3. Press  /  to turn it on/off.



Setting	Explanation
ON	This turns on the PRESELECT function.
OFF	This turns off the PRESELECT function.

4. Press .

This confirms the setting and returns to the [MEMORY Screen](#) or [EFFECT Screen](#).

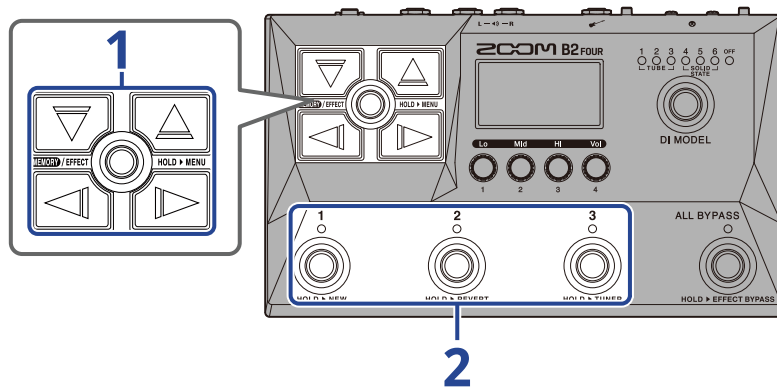

# Selecting patch memories when the PRESELECT function is on



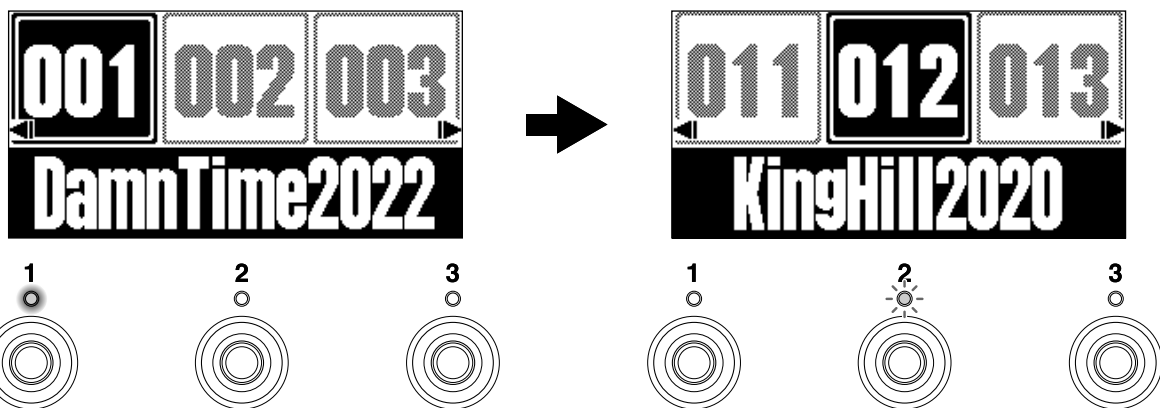

1. On the [MEMORY Screen](#), press , ,  and  to select the patch memory to use next.  
Example: Patch memory 012 selected when playing patch memory 001



The indicator blinks for the footswitch that corresponds to the patch memory selected for use next ( in this case).

2. Press the footswitch (  -  ) with the blinking indicator to confirm the selection.

The patch memory will switch when  -  is pressed, and the indicator for the corresponding footswitch will light (not blinking).

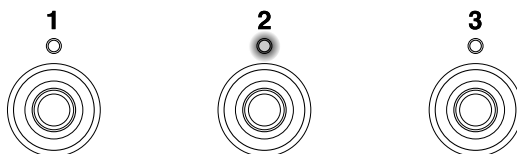

# Editing effects (EFFECT Screen)

Use the [EFFECT Screen](#) to work with effects, including, changing them and adjusting their parameters. Patch memories can be edited.

## Saving changes:

- When the AUTO SAVE function is ON, changes to patch memories will be automatically saved. (This function is ON by default.) (→ [Setting the AUTO SAVE function](#))
- Patch memories will not be saved automatically if the AUTO SAVE function is OFF. When the content of a patch memory has been changed, **EDITED** will appear at the top right of the display, showing that it is different from the saved settings. Save it as necessary. (→ [Copying and saving patch memories](#))



## Opening the EFFECT Screen

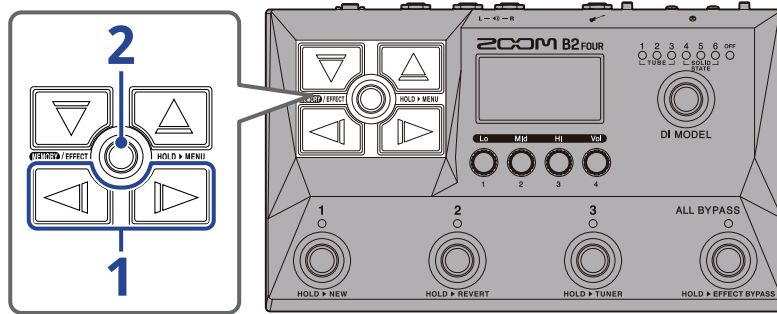

1. On the [MEMORY Screen](#), use  and  to select the patch memory with the effect to be edited (→ [Switching patch memories while playing \(MEMORY Screen\)](#)).



2. Press **MEMORY/EFFECT** .

This opens the [EFFECT Screen](#) for the selected patch memory.

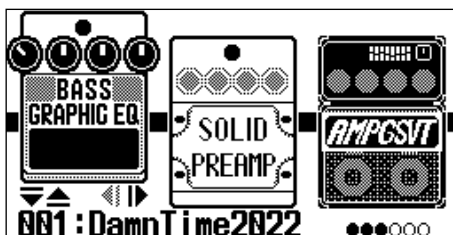

---

**HINT:**

Press **MEMORY/EFFECT**  to return to the [MEMORY Screen](#).



---

# Turning effects on/off

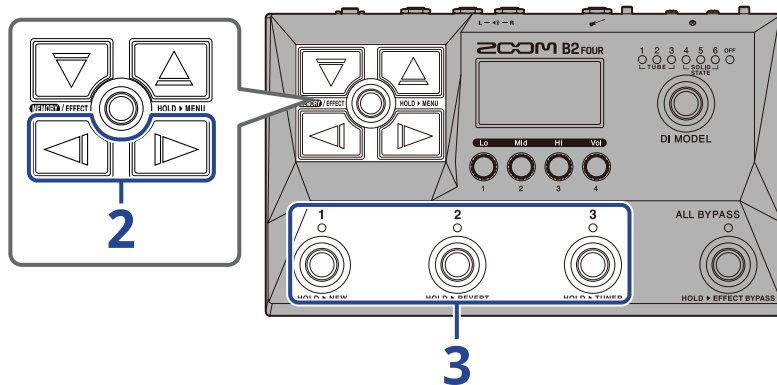
On the [EFFECT Screen](#), the effects and amp used in the patch memory are shown on the display and can be turned on and off using the footswitches.





**1.** Open the [EFFECT Screen](#) for the patch memory with the effect to be turned on/off (→ [Opening the EFFECT Screen](#)).

**2.** Use  and  to show the effect to be turned on/off on the display.

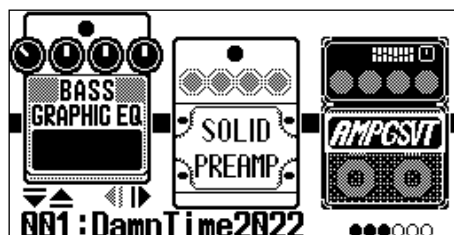
Three effects are shown on the display. The footswitches can be used to turn on/off the effects shown on the display.



**3.** Press footswitches  -  to turn effects on/off.

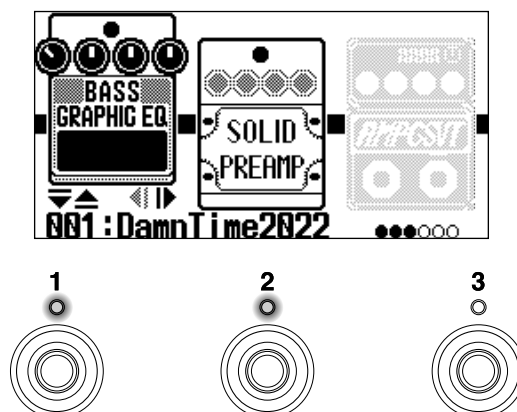

The indicators light when effects are on.

When an effect is off, its indicator will be unlit and its icon will appear dimmed on the display.



---

**HINT:**

Some effects assign special functions to footswitches. (This includes effects that turn on only while the footswitch is being pressed, for example.) Special functions can be selected on the Effect Editing Screen. (→ [Footswitch special functions](#))



---

# Replacing effects

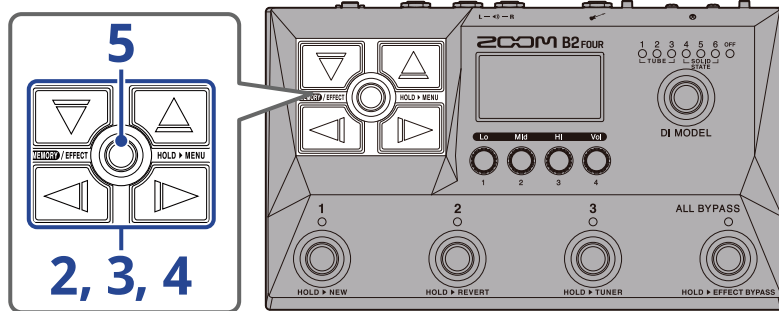
Effects in a patch memory can be replaced with other effects as desired.



**1.** Open the [EFFECT Screen](#) for the patch memory with the effect to be replaced (→ [Opening the EFFECT Screen](#)).



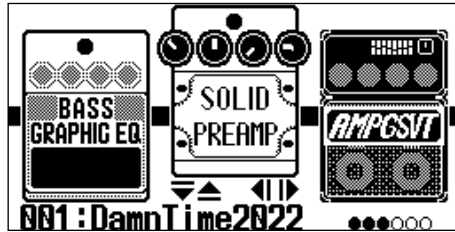

**2.** Use  and  to select the effect to be replaced.



**3.** Press  or .

This opens a list of effects (the [Library Screen](#)). On the Library Screen, the sound of the selected effect can be checked by itself.

**4.** Use , ,  and  to select an effect.

-  /  : Select the higher or lower effect in the same category.
-  /  : Select the category to the left or right.

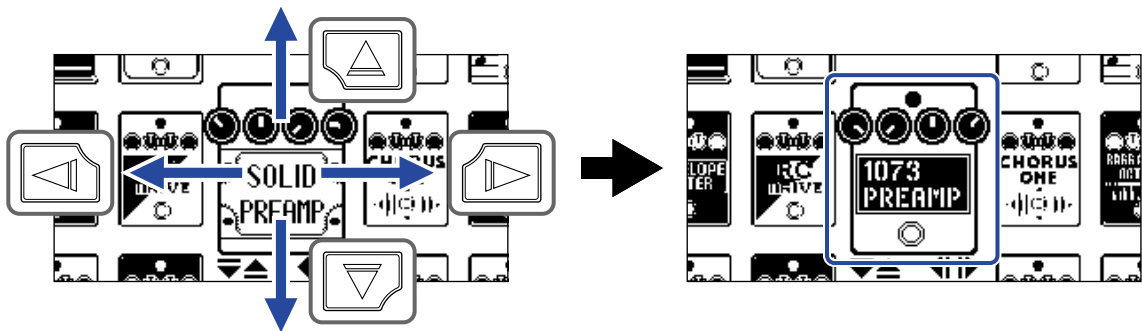

---

**HINT:**

Turning  will open the Effect Editing Screen where parameters for the selected effect can be adjusted.  
(→ [Adjusting effect parameters](#))

---

**5.** Press .

The selected effect or amp will replace the previous one and the [EFFECT Screen](#) will reopen.

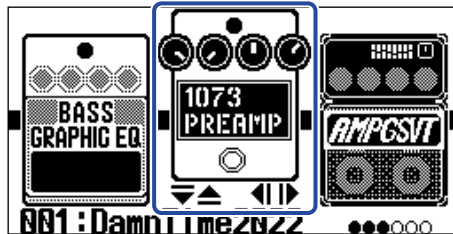
**NOTE:**

- If an effect in a patch memory has been deleted from Handy Guitar Lab, the deleted effect will appear as



and be disabled.

- A patch memory can only contain one effect from each of these categories: amp, pedal, rhythm and looper.
- When the Library Screen is open, sound is output using only the selected effect. To check the sound of the entire patch memory, open the [MEMORY Screen](#) or the [EFFECT Screen](#).

**HINT:**

See Handy Guitar Lab for explanations of each effect.

---

## Adding effects

When a number icon like  is shown, no effect has been assigned to that position. To add an effect, select a number icon in step 2. Then, select an effect starting in step 3.

The position of an added effect can be changed by following the instructions in "[Changing the order of effects](#)".

## Deleting effects

Select the effect to be deleted in step 2. Then, select a number icon like  in step 4.

## Note about the number of effects in patch memories

---

The B2 FOUR can be used to freely combine 5 effects. If the processing capability limit is exceeded, however, a "PROCESS OVERFLOW" warning will appear and effects will be bypassed. Change one of the effects to end this condition.

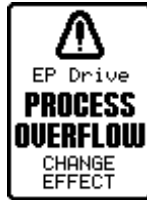

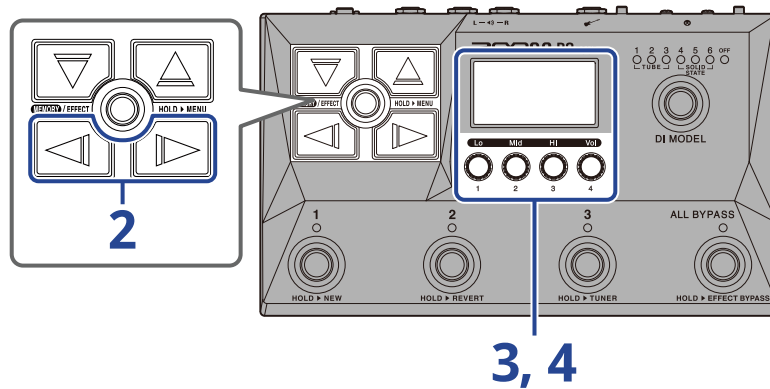

# Adjusting effect parameters

The individual effects used in patch memories can be adjusted.



**1.** Open the [EFFECT Screen](#) for the patch memory that has the effect with parameters to be adjusted (→ [Opening the EFFECT Screen](#)).

**2.** Use  and  to select the effect with parameters to be adjusted.

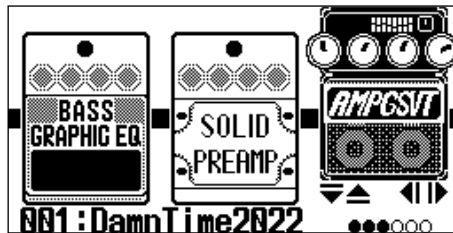

**3.** Turn .

This opens the Parameter Adjustment Screen for the selected effect.

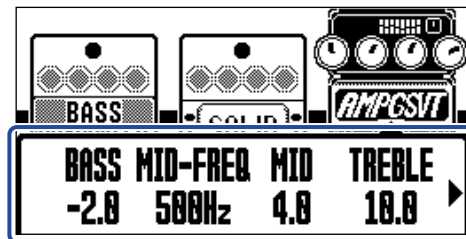

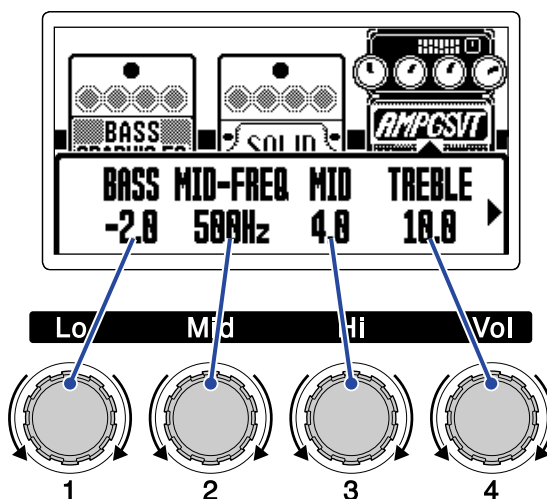

4. Turn  to adjust the effect parameters.



After finishing adjustments, the previous screen will reopen after a moment.

Amps and some other effects have more parameters, so their setting screens have two pages.

Press  and  to show the parameter to be adjusted.

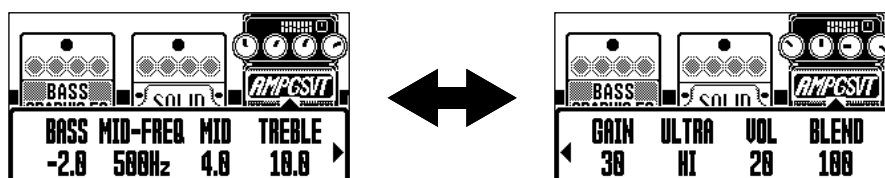

#### HINT:

- Time, rate and other effect parameters can be set to musical notes to sync them to the tempo. (→ [Adjusting the tempo](#))
- See Handy Guitar Lab for explanations of each effect.
- To change, add or delete an effect see "[Replacing effects](#)".

## Footswitch special functions

Some effects assign special functions to footswitches, including turning the effect on only while the footswitch is being pressed. Parameters that select special functions appear inverted on the display.

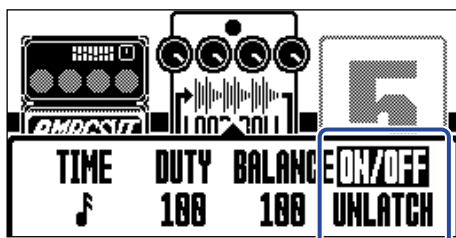

# Changing the order of effects

Effects in a patch memory can be reordered as desired.

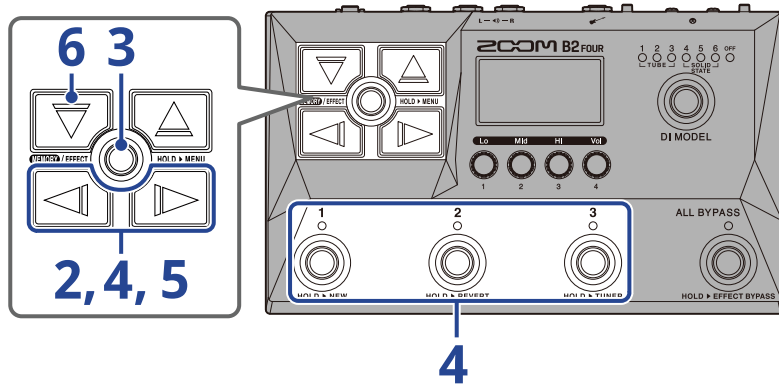

**1.** Open the [EFFECT Screen](#) for the patch memory with effects to be reordered (→ [Opening the EFFECT Screen](#)).

**2.** Use and to select an effect to reorder.

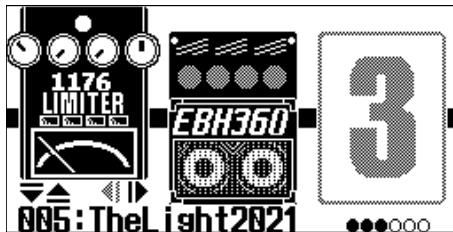

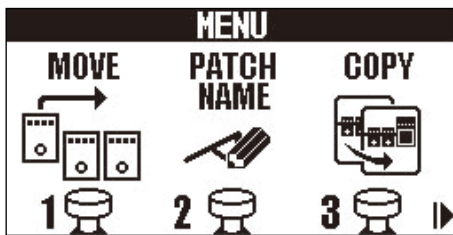

**3.** Press and hold to open the [MENU Screen](#).

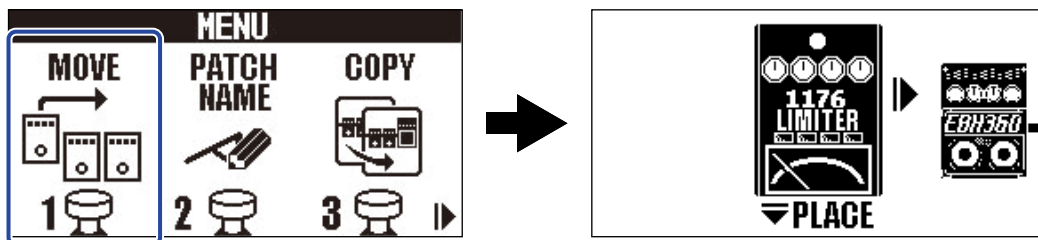

**4.** Use and to select MOVE, and press the corresponding footswitch ( in this example).

This opens the Move Screen.



5. Use  and  to move the effect to the desired position.

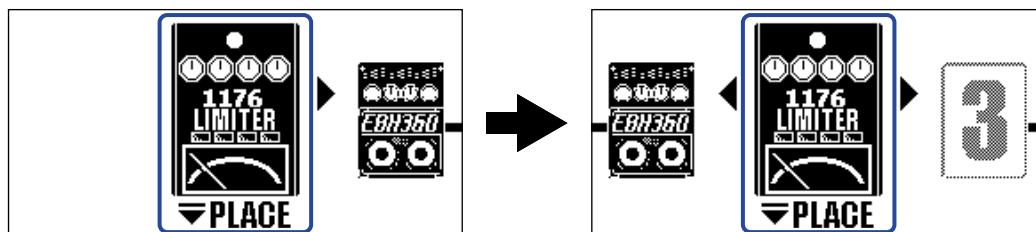

6. Press .



This confirms the reordering and reopens the [EFFECT Screen](#).



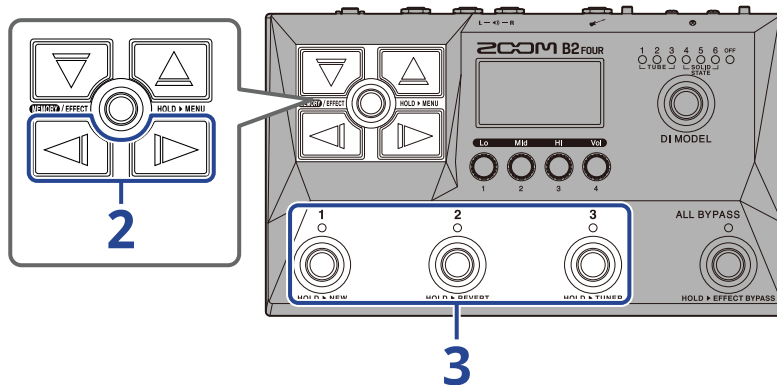

# Adjusting the tempo

The tempo used by rhythms, the looper, delay effects and some modulation effects can be adjusted. Tempo is set separately for each patch memory.

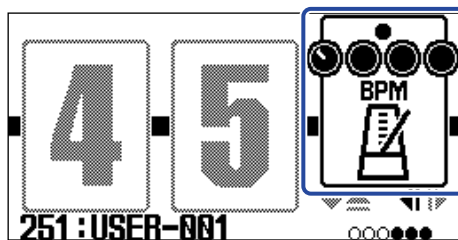

1. Open the [EFFECT Screen](#) for the patch memory with the tempo to be changed (→ [Opening the EFFECT Screen](#)).
2. Use  /  to select the BPM module.



3. Press the corresponding footswitch (  in this example).

The tempo can also be set by tapping the footswitch repeatedly (tap tempo).

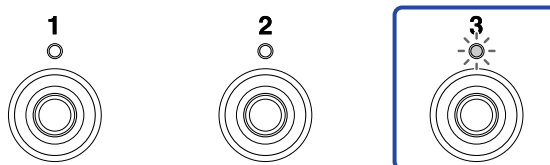
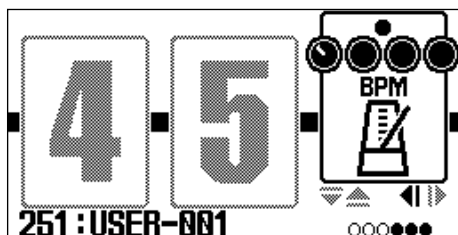

The indicator blinks at the set tempo interval.

---

**HINT:**

- The tempo can be set to 40–250 ♩ per minute (bpm).
- Turning  will open the Tempo Adjustment Screen where the tempo can be set.

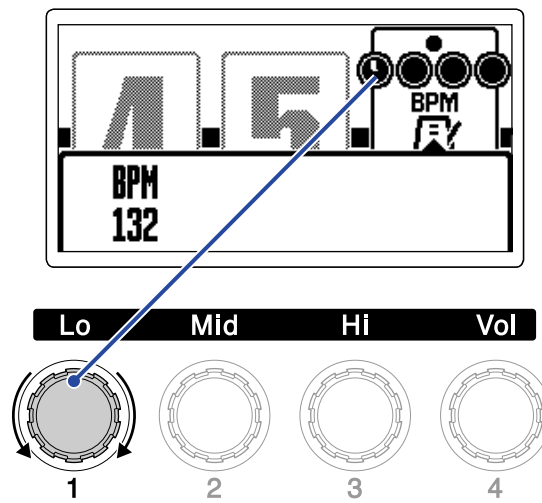

The set tempo is shown on the display.

After finishing the setting, the screen will return to its previous state after a moment.

---

# Managing patch memories

## Changing patch memory names

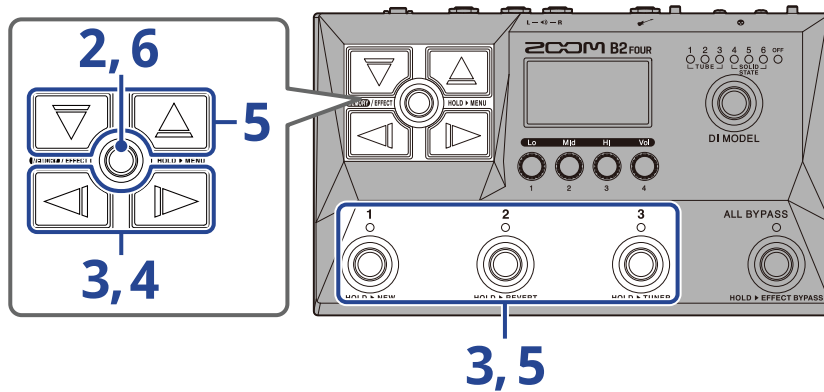

1. Show the patch memory with the name to be changed (→ [Switching patch memories while playing \(MEMORY Screen\)](#)).

2. Press and hold **MEMORY/EFFECT** (⊙) to open the [MENU Screen](#).

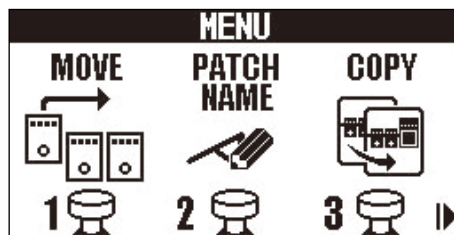

3. Use / to select PATCH NAME, and press the corresponding footswitch (⊙<sup>2</sup> in this example).

This opens the PATCH NAME screen.

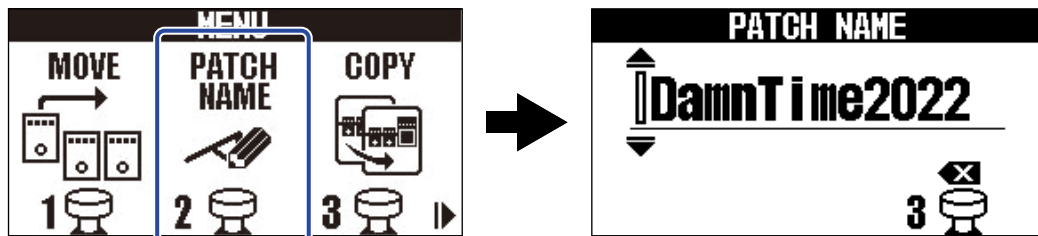





4. Use  and  to move the cursor.



5. Use  and  to insert a character.



- Press and hold  /  to change the character continuously.
- Press  to delete the character before the cursor.
- Press and hold  to delete all the characters.

6. Press .

This confirms the name and reopens the [MEMORY Screen](#).

---

**HINT:**

The characters and symbols that can be used are as follows.

! % & ' + , - . = \_ (space) A-Z, a-z, 0-9

---

# Copying and saving patch memories

The AUTO SAVE function is on by default. When it is off, changes, including adjustments to effects and amps, as well as volume settings, will not be saved automatically. Save changes manually in this case. Patch memories can also be saved (copied) to other locations.

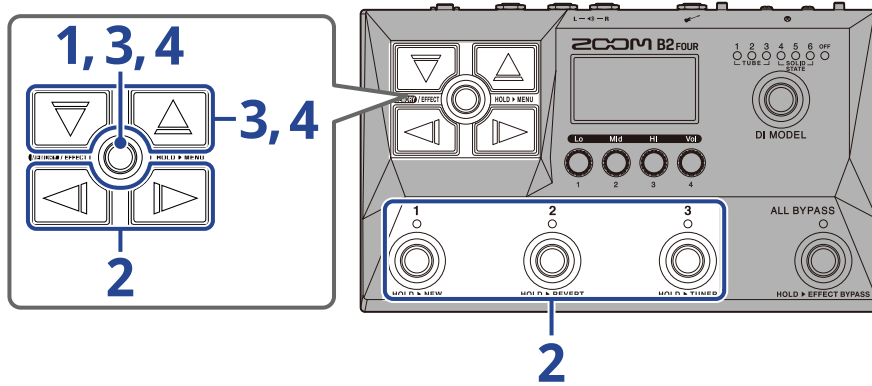



**HINT:**

See "[Setting the AUTO SAVE function](#)" for details about the AUTO SAVE function.

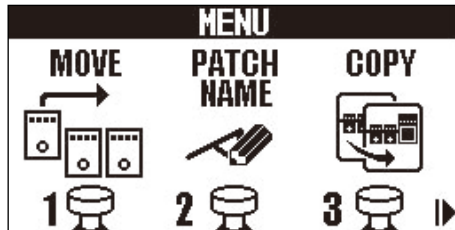
1. Press and hold **MEMORY/EFFECT**  to open the [MENU Screen](#).



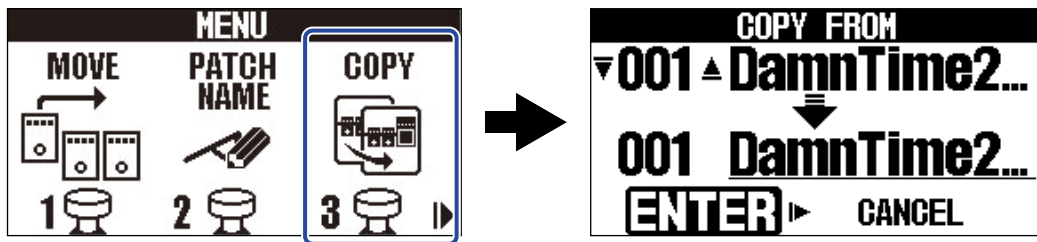

2. Use  /  to select COPY, and press the corresponding footswitch (  in this example).

This opens the Copy Screen.





"SAVE" will be shown instead of "COPY" when the AUTO SAVE function is OFF, so select "SAVE" (→[Setting the AUTO SAVE function](#)) .



3. Use  and  to select the patch memory to copy, and press .



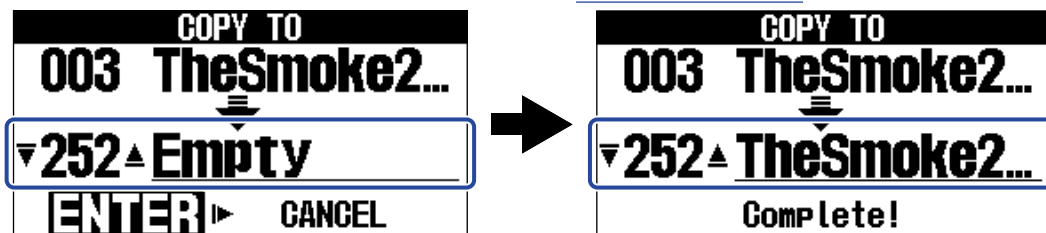

4. Use  and  to select the patch memory copy/save destination, and press . This copies/saves the patch memory, and reopens the [MEMORY Screen](#).



Patch memories shown as “Empty” are currently unused.

**HINT:**

- In step 3 or 4, pressing  to select “CANCEL” and pressing  will cancel copying/saving and reopen the [MEMORY Screen](#).
- Patch memories will not be saved automatically if the AUTO SAVE function is OFF. When the AUTO SAVE function is OFF, if the content of a patch memory has been changed, **EDITED** will appear at the top right of the screen, showing that it is different from the saved settings. (→ [Setting the AUTO SAVE function](#))



- When the AUTO SAVE function is OFF, “SAVE” will be shown instead of “COPY” in step 2. (→ [Setting the AUTO SAVE function](#))

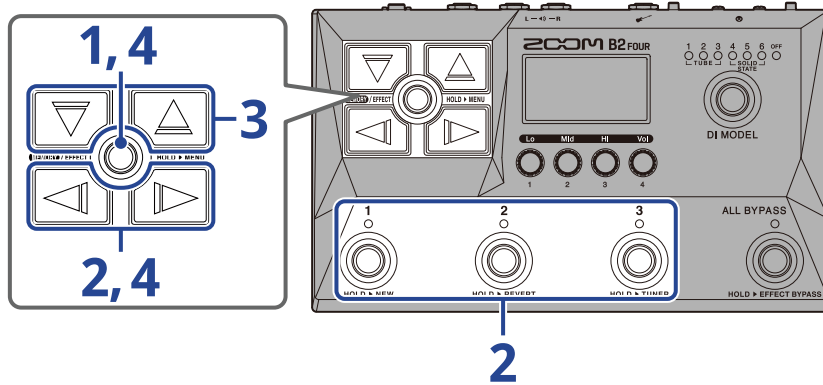

# Deleting patch memories

Unnecessary patch memories can be deleted.



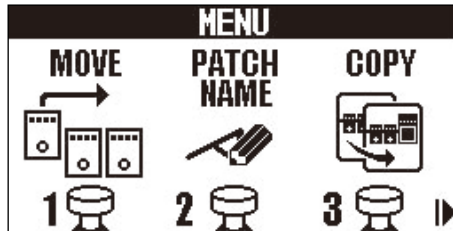

1. Press and hold **MEMORY/EFFECT**  to open the **MENU Screen**.

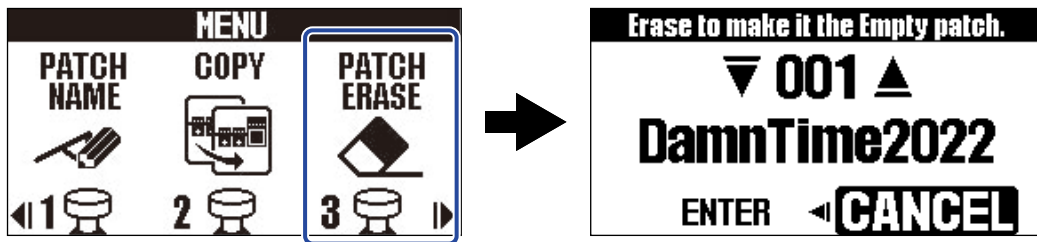

2. Use  /  to select **PATCH ERASE**, and press the corresponding footswitch ( in this example).

This opens the **PATCH ERASE** screen.



3. Use  and  to select the patch memory to be deleted.



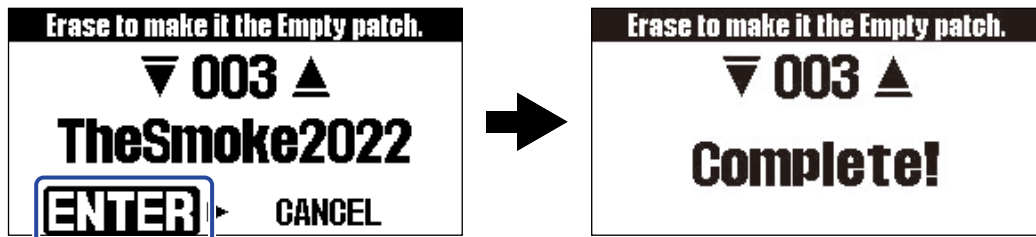

4. Press  to select ENTER, and press  .



Deleted patch memories will have their contents cleared and be shown as "Empty".

---

**HINT:**

In step 4, pressing  to select "CANCEL" and pressing  will cancel deletion and reopen the [MEMORY Screen](#).

---



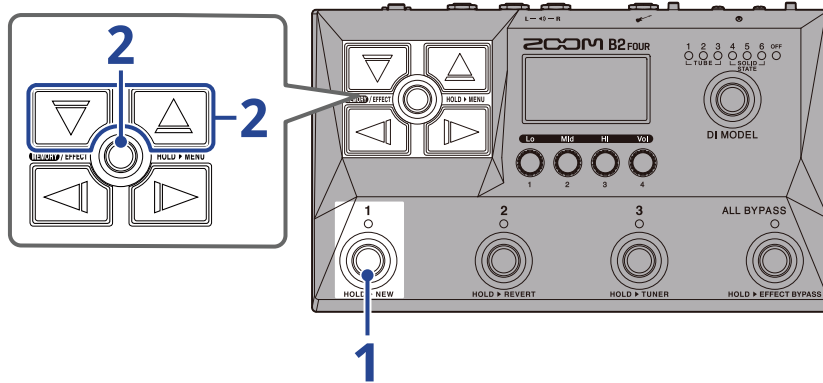

# Creating patch memories

New patch memories can be created.



1. Press and hold footswitch .  
This opens the New Screen.



2. Use  and  to select where the new patch memory will be saved, and press .  
This creates a new patch memory and opens the [EFFECT Screen](#).

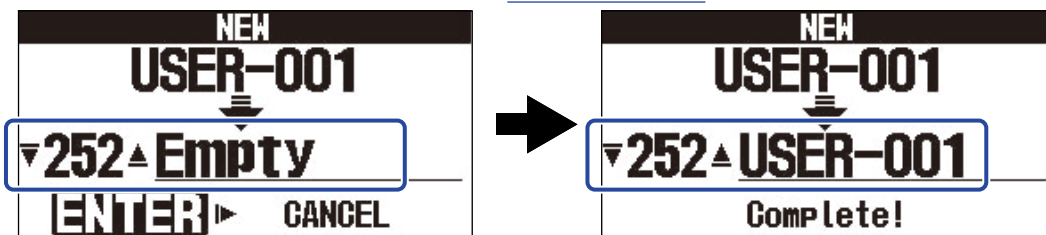



Assign effects by following the procedures in [“Replacing effects”](#) and edit the patch memory.

## NOTE:

Up to 300 patch memories can be saved. The New Screen will not be shown if there are no empty patch memories. Delete unnecessary patch memories to enable use. (→ [Deleting patch memories](#))

## HINT:

In step 2, pressing  to select “CANCEL” and pressing  will cancel creation and reopen the [MEMORY Screen](#).

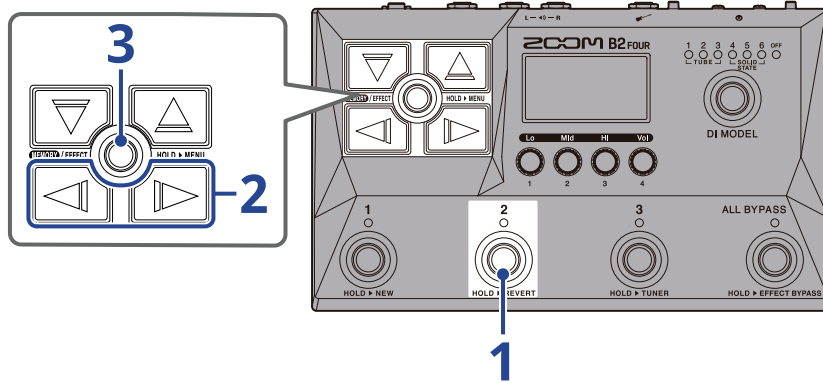

# Reverting patch memory changes

After changing a patch memory, it can be reset to the state it was in immediately after it was selected or to the factory default state.



1. Press and hold footswitch . This opens the Revert Screen.



2. Use  and  to select the desired state.



Setting	Explanation
PREVIOUS	This reverts the patch memory to its state immediately after selection.
FACTORY	This reverts the patch memory to its factory default state.



3. Press  .



This reverts the patch memory to the state selected in step 2 and reopens the [MEMORY Screen](#).

---

**HINT:**

In step 2, pressing  to select "CANCEL" and pressing  will cancel the operation and reopen the [MEMORY Screen](#).

---

# Using the tuner

## Activating the tuner

Enable the tuner to use the B2 FOUR to tune a bass.

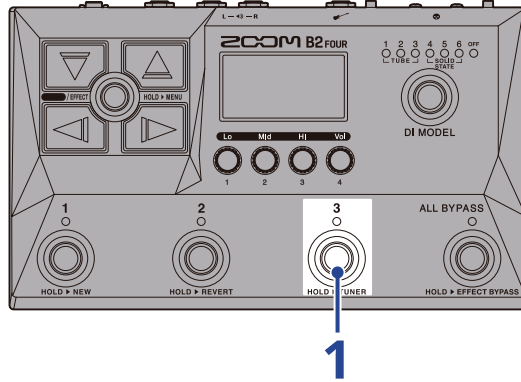

1. Press and hold .

This activates the tuner and opens the Tuner Screen on the display.

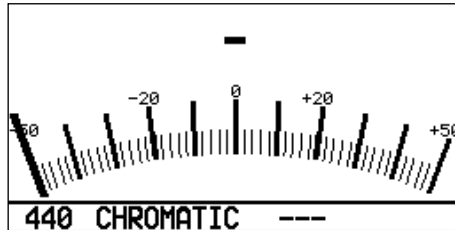

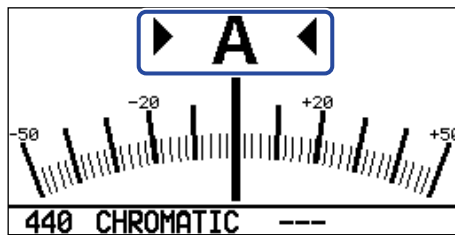

2. Play the open string that you want to tune and adjust its pitch.



- The nearest note name and pitch detuning will be shown.
- The left and right indicators will be shown when the pitch is in tune.

## Closing the tuner

Press footswitch  -  when the tuner is in use to close it and reopen the previous screen.

## Changing tuner settings

The standard pitch used by the tuner and the tuner type can be changed. Flat tuning is also possible.

### Changing the standard pitch of the tuner

Turn  to change the standard pitch.

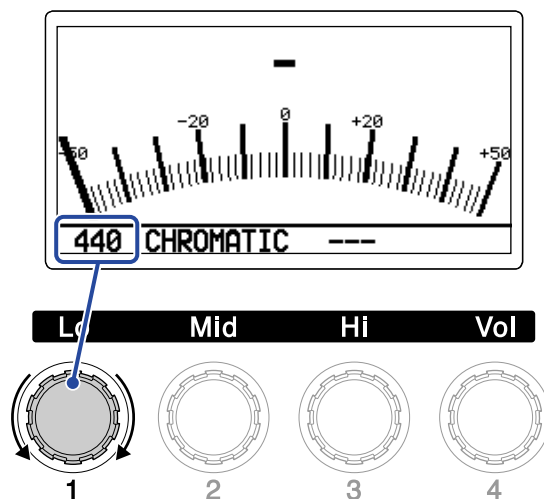

#### HINT:

The setting range is 430–450 Hz for middle A.

## Selecting the tuner type

Turn  to select the tuner type.

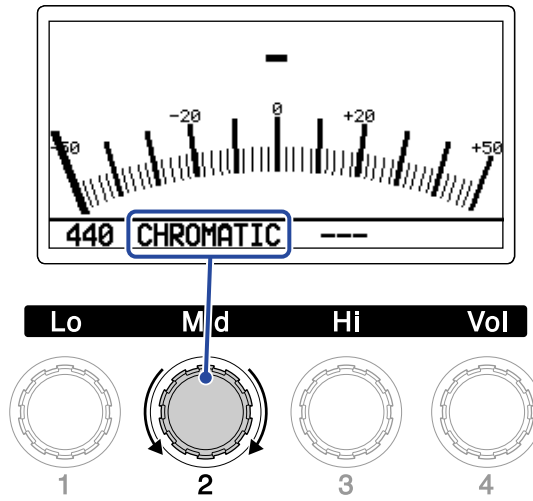

Setting	Explanation
CHROMATIC	The pitch detuning is shown according to the nearest note (in semitones).
BASS	This is standard bass guitar tuning with support for 5/6-string basses. The nearest string number is shown according to the selected type, and the amount of detuning from its pitch is shown.

BASS tuning (“LB” is low B and “HC” is high C.)

String	LB	4	3	2	1	HC
Note	B	E	A	D	G	C

## Using flat tunings

All strings can be tuned flat from an ordinary tuning by 1 ( $b \times 1$ ), 2 ( $b \times 2$ ) or 3 ( $b \times 3$ ) semitones.

Turn  to set flat tuning.

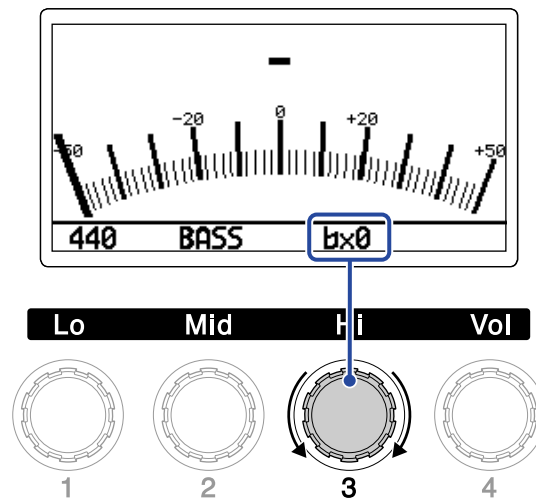

### NOTE:

Flat tuning cannot be used when the tuner type is CHROMATIC.



# Using a connected expression pedal

The application of a pedal effect selected in the patch memory can be changed by operating a connected expression pedal (ZOOM FP02M).

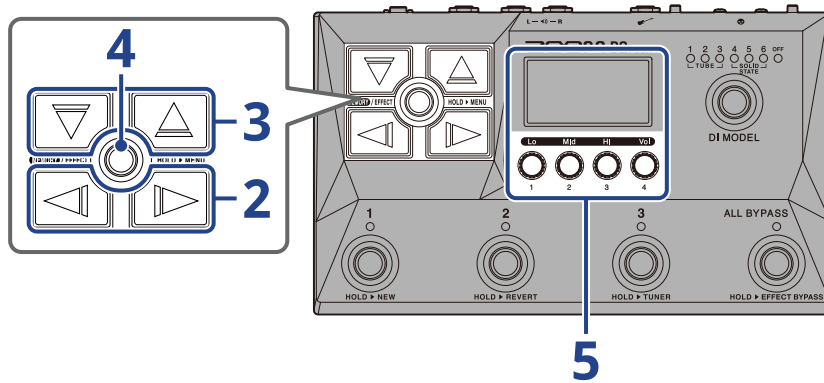





## Setting pedal effects

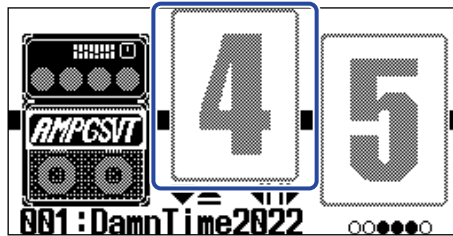

**1.** Open the [EFFECT Screen](#) for the patch memory with the pedal effect to be set (→ [Opening the EFFECT Screen](#)).

**2.** Use  and  to select the effect to use for the pedal effect.



**3.** Press  /  to open the [Library Screen](#), and use , ,  and  to select a pedal effect.

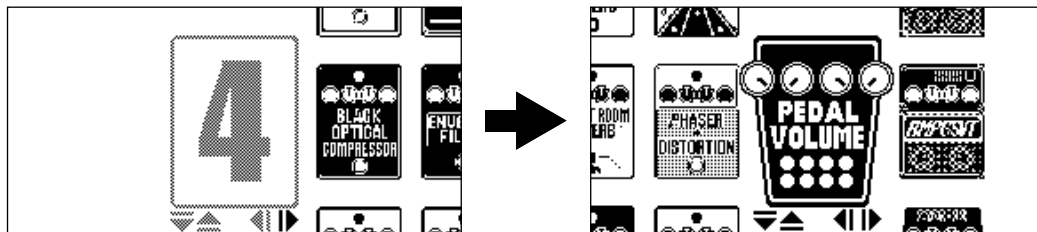

When the [Library Screen](#) is open, the sound of the selected effect can be checked by itself.



4. Press **MEMORY/EFFECT** .

This changes the selected pedal effect and opens the **EFFECT Screen**.

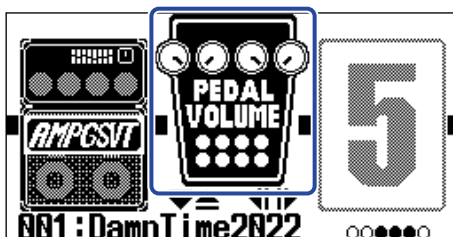

**NOTE:**

Only one effect in a patch memory can be selected from the pedal category.

5. With the pedal effect selected, turn  to adjust its parameters.

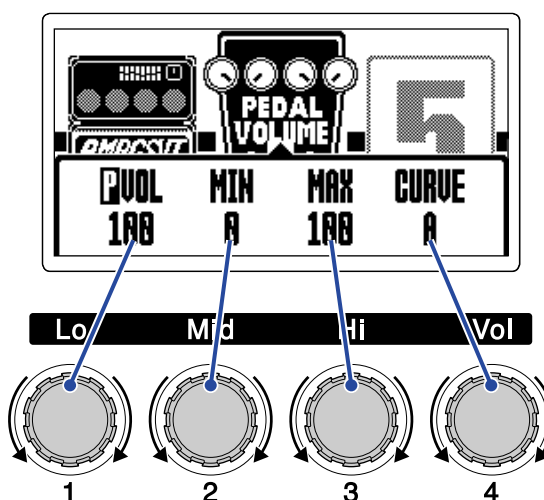

The parameters that can be adjusted depend on the pedal effect.

6. Use the expression pedal.

This changes the application of the effect.

The parameter with  added to it on the Effect Editing Screen in step 5 can be adjusted.



# Using rhythms

You can play along with built-in rhythms.

## Setting the rhythm effect



On the B2 FOUR, one rhythm can be used as an effect, and it can be started and stopped by turning the effect on/off.

Select the rhythm effect on the [EFFECT Screen](#) to make various rhythms settings, including rhythm pattern selection and tempo.

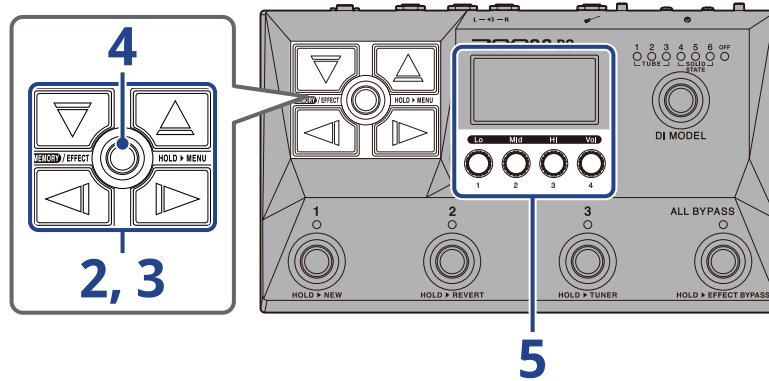





Each patch memory can have only one rhythm effect set.

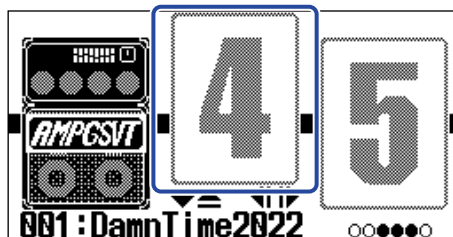

**1.** Open the [EFFECT Screen](#) for the patch memory with the rhythm effect to be set (→ [Opening the EFFECT Screen](#)).

**2.** Use  and  to select the effect to use for the rhythm effect.



**3.** Press  /  to open the [Library Screen](#), and use , ,  and  to select a rhythm effect.

The rhythm effect is in the column second from the right on the Library Screen.



4. Press **MEMORY/EFFECT** .

This opens the [EFFECT Screen](#).



5. Turn  to adjust the rhythm effect settings.

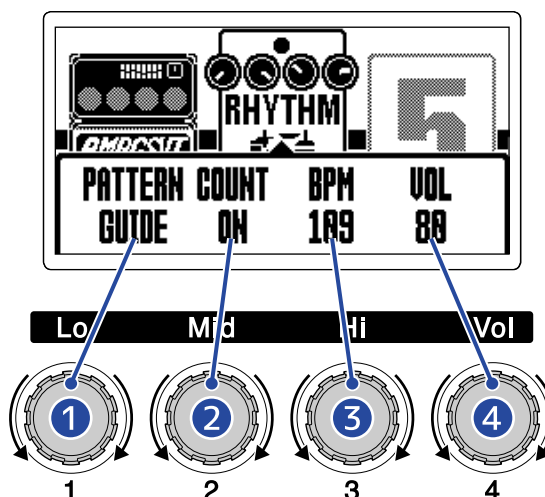

### 1 Rhythm pattern

This selects the rhythm pattern that will be played.

See [Rhythm patterns](#) for information about the rhythm pattern types.

### 2 Pre-count

This sets whether or not a count sound is played before looper recording starts.

- OFF: A precount is not played.
- ON: A precount is played.

### 3 Tempo

This adjusts the rhythm tempo.

- This can be set from 40 to 250.
- The tempo set here is linked to the tempo adjusted in [“Adjusting the tempo”](#) and will be shared by the other effects and the looper.

### 4 Volume

This adjusts the volume of the rhythm.

- This can be set from 0 to 100.

---

#### HINT:



Rhythm settings can be changed during rhythm playback. (→ [Starting/stopping rhythm playback](#))

---

# Starting/stopping rhythm playback

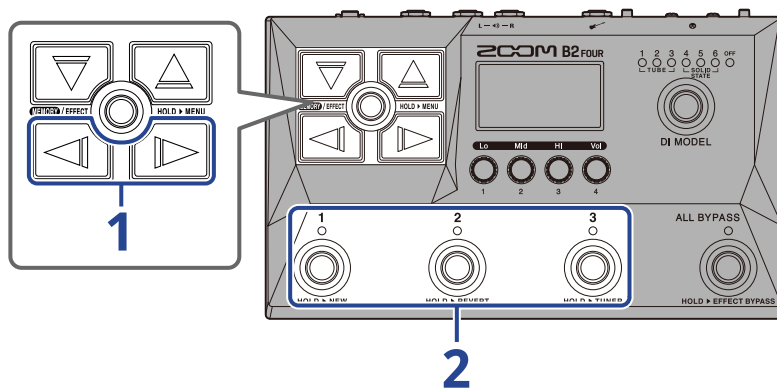
Rhythm playback can be started and stopped.



1. Use  and  to show the rhythm effect on the display.



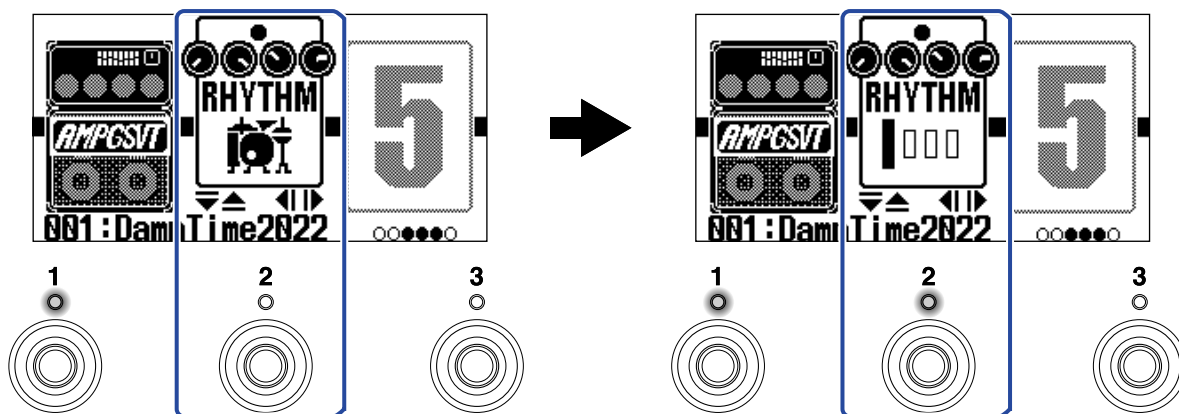

2. Press the  -  footswitch that corresponds to the rhythm effect (  in this example).



Press that footswitch again to alternate between starting and stopping playback.  
The indicator lights during playback.

## HINT:

- During rhythm playback, it will continue playing even if  is pressed to switch to the [MEMORY Screen](#). In this case, switching the patch memory will stop the rhythm.
- Pressing  /  to open the [Library Screen](#) will stop the rhythm.

## Rhythm patterns

No.	Pattern Name	Time Sig.	No.	Pattern Name	Time Sig.	No.	Pattern Name	Time Sig.
1	GUIDE	4/4	24	R&B1	4/4	47	JAZZ2	4/4
2	8BEATS1	4/4	25	R&B2	4/4	48	FUSION	4/4
3	8BEATS2	4/4	26	70S SOUL	4/4	49	SWING1	4/4
4	8BEATS3	4/4	27	90S SOUL	4/4	50	SWING2	4/4
5	16BEATS1	4/4	28	MOTOWN	4/4	51	BOSSA1	4/4
6	16BEATS2	4/4	29	HIPHOP	4/4	52	BOSSA2	4/4
7	16BEATS3	4/4	30	DISCO	4/4	53	SAMBA1	4/4
8	ROCK1	4/4	31	POP	4/4	54	SAMBA2	4/4
9	ROCK2	4/4	32	POPROCK	4/4	55	BREAKS1	4/4
10	ROCK3	4/4	33	INDIEPOP	4/4	56	BREAKS2	4/4
11	ROCKABLY	4/4	34	EUROPOP	4/4	57	BREAKS3	4/4
12	R'N'R	4/4	35	NEWWAVE	4/4	58	12/8 GRV	12/8
13	HARDROCK	4/4	36	ONEDROP	4/4	59	WALTZ	3/4
14	HEAVYMTL	4/4	37	STEPPERS	4/4	60	JZWALTZ1	3/4
15	MTLCORE	4/4	38	ROCKERS	4/4	61	JZWALTZ2	3/4
16	PUNK	4/4	39	SKA	4/4	62	CTWALTZ1	3/4
17	FASTPUNK	4/4	40	2ND LINE	4/4	63	CTWALTZ2	3/4
18	EMO	4/4	41	COUNTRY	4/4	64	5/4 GRV	5/4
19	TOMTOMBT	4/4	42	SHUFFLE1	4/4	65	METRO3	3/4
20	FUNK1	4/4	43	SHUFFLE2	4/4	66	METRO4	4/4
21	FUNK2	4/4	44	BLUES1	4/4	67	METRO5	5/4
22	FUNKROCK	4/4	45	BLUES2	4/4	68	METRO	
23	JAZZFUNK	4/4	46	JAZZ1	4/4			

# Using the looper while playing

Playing can be recorded to create mono loop phrases that are up to 60 seconds long.

## Setting the looper effect

Various looper settings can be made.



On the B2 FOUR, one looper can be used as an effect, and it can be started and stopped by turning the effect on/off.

Select the looper effect on the [EFFECT Screen](#) to make various looper settings, including loop recording time and volume.

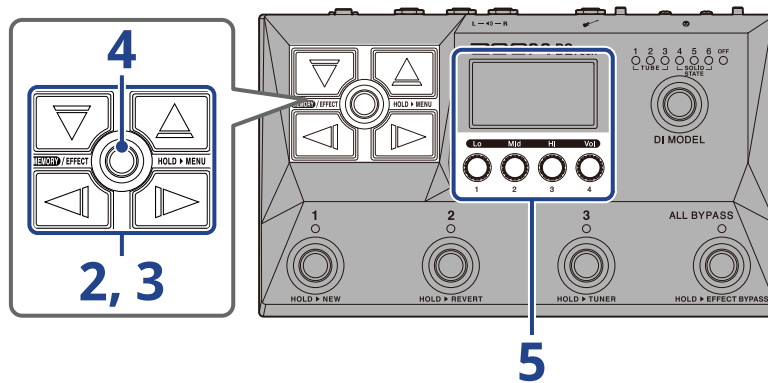





Each patch memory can have only one looper effect set.

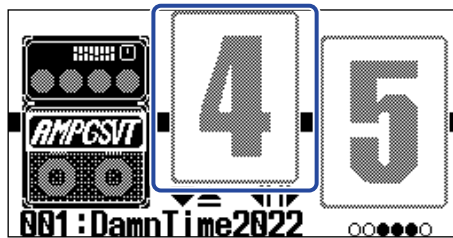

**1.** Open the [EFFECT Screen](#) for the patch memory that will have the looper effect set (→ [Opening the EFFECT Screen](#)).

**2.** Use  and  to select the effect to use for the looper effect.



3. Press  /  to open the [Library Screen](#), and use , ,  and  to select the looper effect.

The looper effects are in the second column from the right on the Library Screen. Choose either the MONO LOOPER or the STEREO LOOPER.

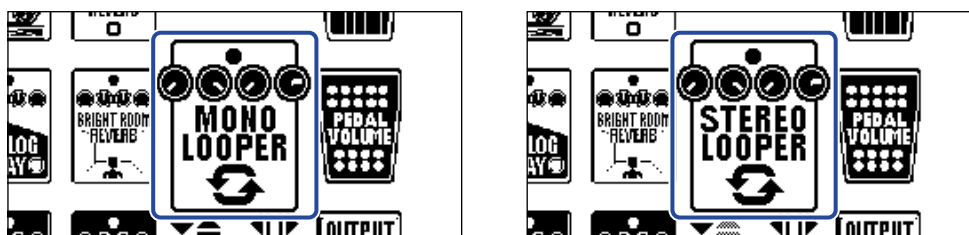



**NOTE:**

- The recording time for the mono looper is from 1.5 to 60 seconds (30 seconds when UNDO is ON).
- The recording time for the stereo looper is from 1.5 to 30 seconds (15 seconds when UNDO is ON).

4. Press  / .

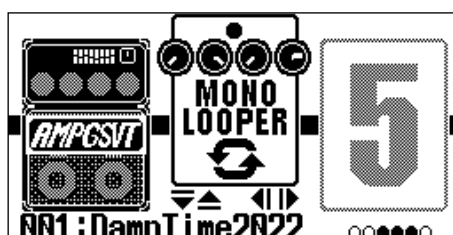
This opens the [EFFECT Screen](#).



5. Turn  to adjust the looper effect settings.

See the reference links for details about the settings.

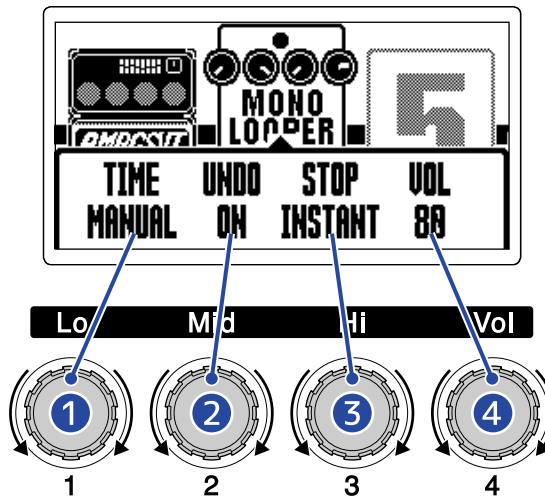

- 1 Loop recording time**  
This sets the recording time for the loop. (→ [Setting the recording time](#))
- 2 Undo function setting**  
This turns on/off the undo function that can be used to undo the last recorded overdub of a loop. (→ [Setting the UNDO function](#))
- 3 Stop mode**  
This sets how the looper behaves when loop playback is stopped. (→ [Setting the stop mode](#))
- 4 Volume**  
This adjusts the looper volume. (→ [Adjusting the volume](#))



# Setting the recording time

This sets the recording time for the loop.

1. Turn  on the Looper Effect Setting Screen (→ [Setting the looper effect](#)).

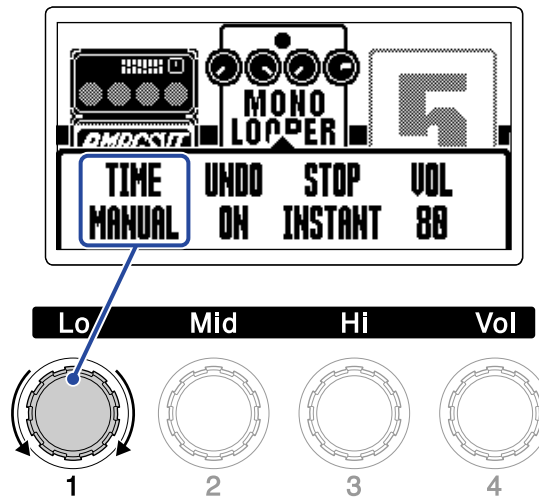

Setting	Explanation
MANUAL	Recording will continue until stopped manually or the maximum recording time is reached.
♩×1-64	This sets the value to 1 - 64 quarter notes. The actual recording time depends on the BPM (tempo) setting (→ <a href="#">Adjusting the tempo</a> ). The recording time (seconds) = $60 \div \text{BPM} \times \text{quarter notes}$ . When the set recording time is reached, recording will stop and loop playback will start.

## NOTE:

- The setting options include MANUAL and 1 - 64 quarter notes.
- The looper recording time is 1.5 - 30 seconds (15 when UNDO is ON) for stereo, and 1.5 - 60 seconds (30 when UNDO is ON) for mono. To switch between stereo and mono, see "[Setting the looper effect](#)".
- Settings that would exceed the maximum recording time will be adjusted automatically.
- Changing the recording time will delete the recorded data.

## Setting the UNDO function

This turns on/off the undo function that can be used to undo the last recorded overdub of a loop.

1. Turn  on the Looper Effect Setting Screen (→ [Setting the looper effect](#)).

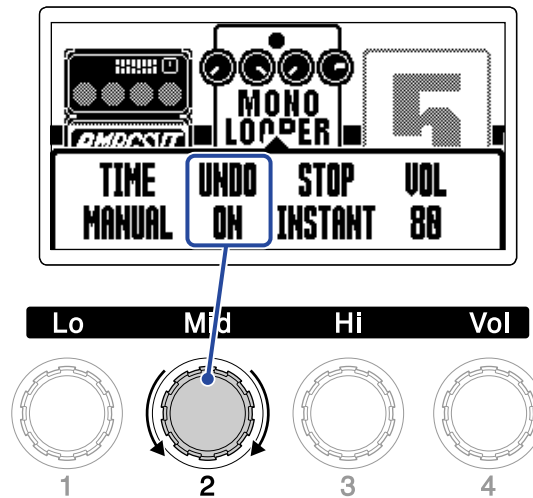

Setting	Explanation
ON	This enables the UNDO function.
OFF	This disables the UNDO function.

### NOTE:

The looper recording time is 1.5 – 30 seconds (15 when UNDO is ON) for stereo, and 1.5 – 60 seconds (30 when UNDO is ON) for mono. To switch between stereo and mono, see "[Setting the looper effect](#)".

## Setting the stop mode

How the looper behaves when stopped can be set.

1. Turn  on the Looper Effect Setting Screen (→ [Setting the looper effect](#)).

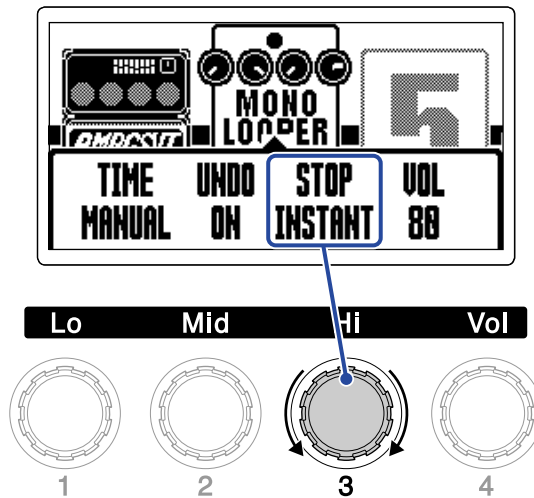

Setting	Explanation
INSTANT	The loop will stop immediately after a stop operation.
FINISH	The loop will stop after playing to its end.
FADE OUT	The loop will stop playing after fading out.

## Adjusting the volume

The looper volume can be adjusted.

1. Turn  on the Looper Effect Setting Screen (→ [Setting the looper effect](#)).

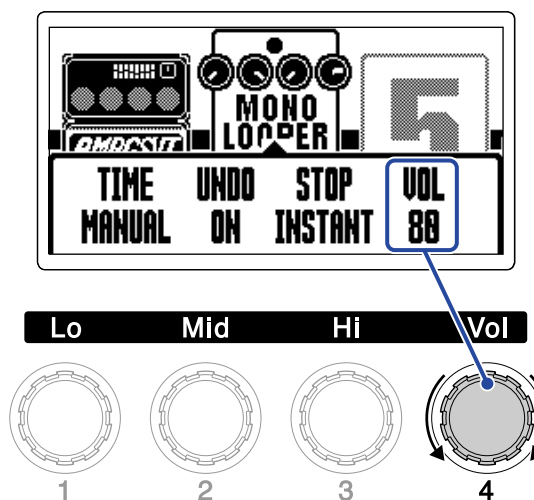

### HINT:

This can be set from 0 to 100.

## Notes about the looper tempo

---

- The looper tempo is also used by effects and rhythms.
- The tempo can be set as explained in "[Adjusting the tempo](#)".
- Changing the tempo will erase recorded loops in the following cases.
  - If the looper recording time is set to  $\downarrow \times 1-64$  (→ [Setting the recording time](#))
  - If a rhythm is playing (→ [Using rhythms](#))

### NOTE:

- If the rhythm pre-count function is on, recording will start after the pre-count. (→ [Setting the rhythm effect](#))
- Sound input through the AUX IN jack will not be recorded.

### HINT:



During rhythm playback (→ [Using rhythms](#)), quantization is enabled so even if the recording ending time is not exact, the loop will automatically be adjusted so that loop playback stays in time.

---



# Looper operations

Looper recording, playback and other operations can be conducted when the looper effect is shown on the [EFFECT Screen](#).

## HINT:

- Looper recording/playback will continue even if **MEMORY/EFFECT**  is pressed to switch to the [MEMORY Screen](#). In this case, changing patch memories will stop recording/playback and erase the recorded data.
- Pressing  /  to open the [Library Screen](#) will stop recording/playback.

## Recording loops

1. When a loop has not yet been recorded, press the  -  footswitch that corresponds to the looper effect (  in this example).

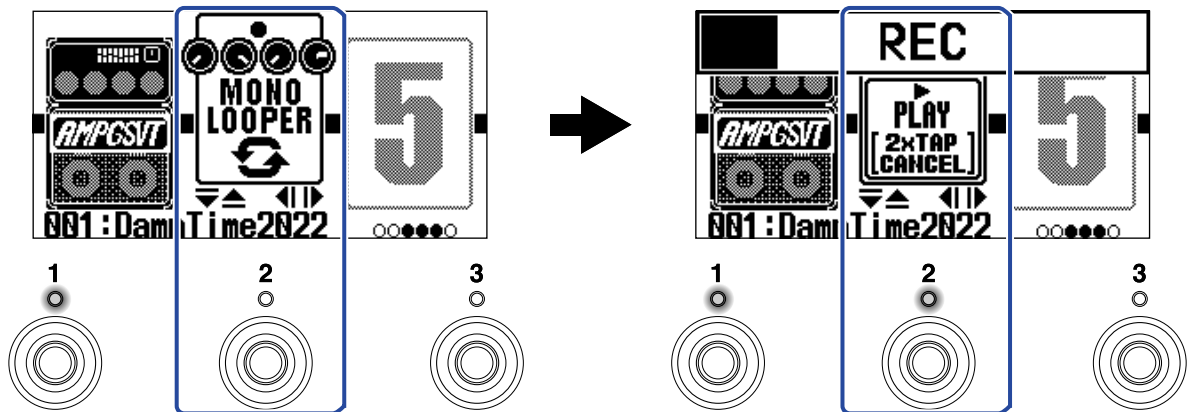

Recording will start and the indicator will light.

Press the footswitch with the lit indicator 2 times to cancel recording.

## Stopping recording and starting loop playback

1. When recording, press the ① - ③ footswitch that corresponds to the looper effect (② in this example).

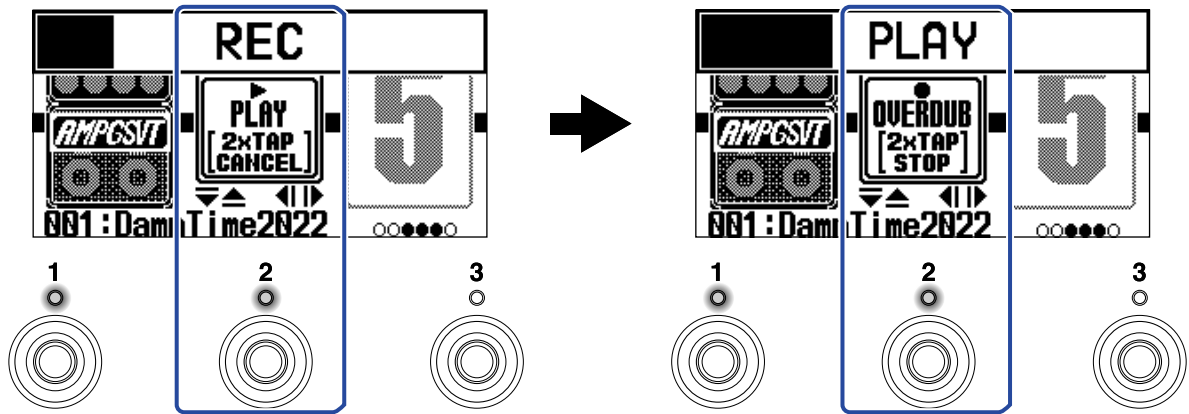

Recording will stop and loop playback will start.

### NOTE:

- If the maximum recording time is reached, recording will stop and loop playback will start.
- If the recording time is set to "J×1-64", recording will stop and loop playback will start after the set recording time has elapsed. (→ [Setting the recording time](#))

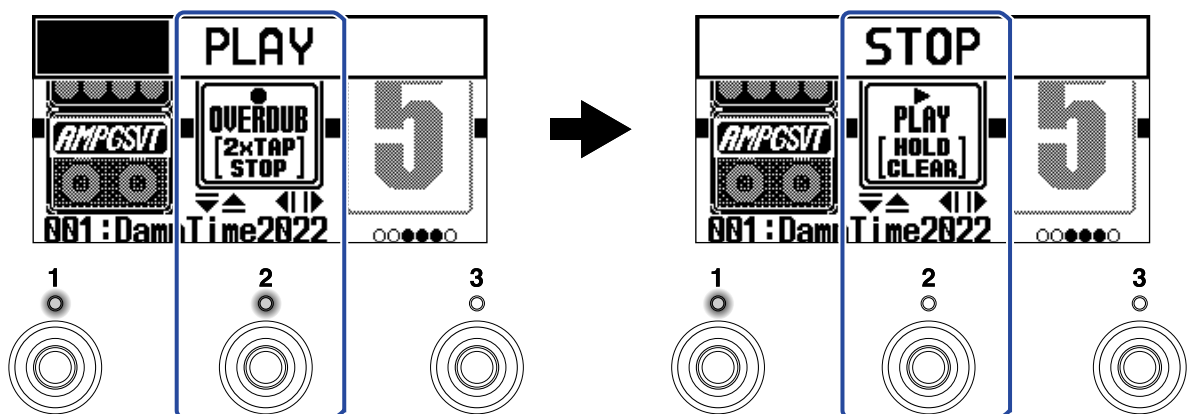

## Stopping playback

1. During playback, press the ① - ③ footswitch that corresponds to the looper effect (② in this example) 2 times.



The indicator becomes unlit when playback stops.

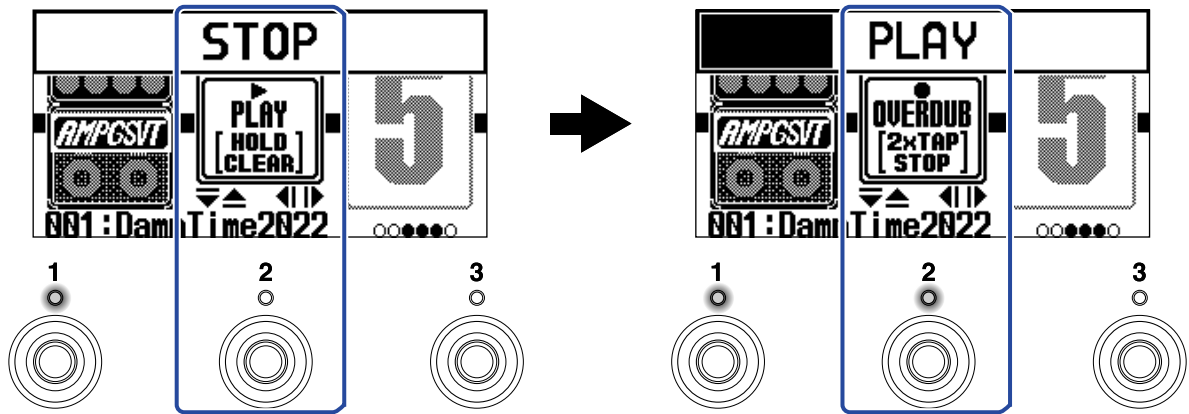

## Starting loop playback of the recorded phrase

1. When stopped, press the  -  footswitch that corresponds to the looper effect ( in this example).



The indicator lights when playback starts.

## Adding performances to recorded loops (overdubbing)

1. When playing, press the  -  footswitch that corresponds to the looper effect ( in this example).

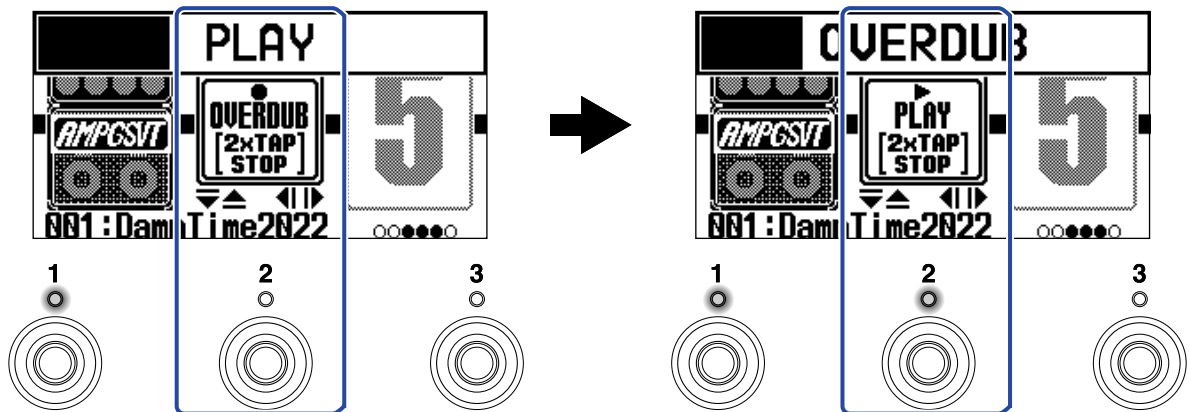

This starts overdubbing.

- When the end of the loop is reached, loop playback will continue from the beginning, and overdubbing can be repeated.
- When overdubbing, press the footswitch with the lit indicator to stop overdubbing, but continue loop playback.



## Erasing the last overdubbed phrase (UNDO function)

The UNDO function can be used when it is set to ON. (→ [Setting the UNDO function](#))

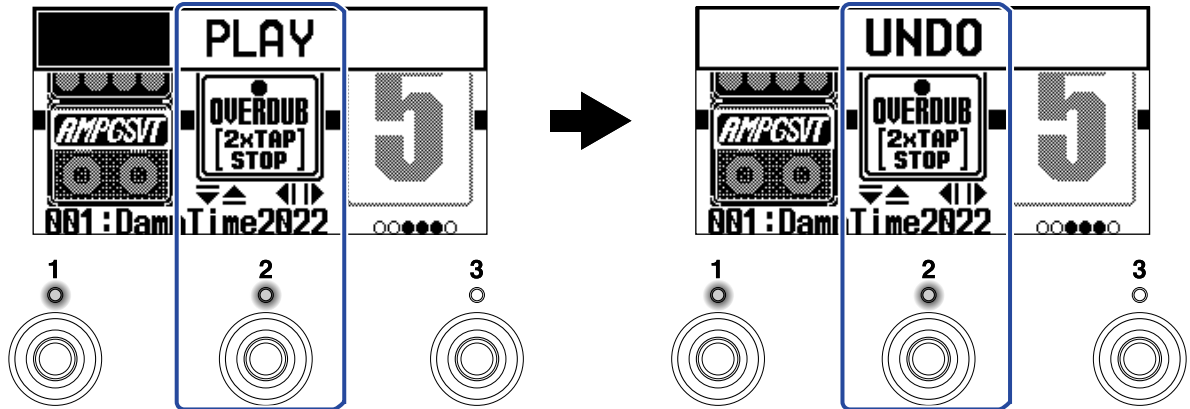
1. During playback, press and hold the  -  footswitch that corresponds to the looper effect ( in this example).



## Restoring an undone overdub (REDO function)

1. After undoing (→ [Erasing the last overdubbed phrase \(UNDO function\)](#)), press and hold the  -  footswitch that corresponds to the looper effect ( in this example).

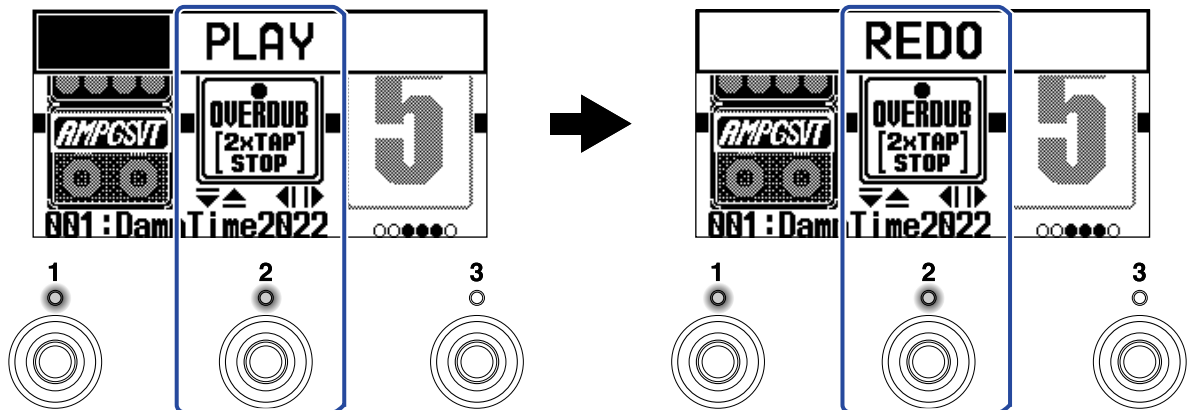



## Clearing loops

1. When stopped, press and hold the ① - ③ footswitch that corresponds to the looper effect (② in this example).

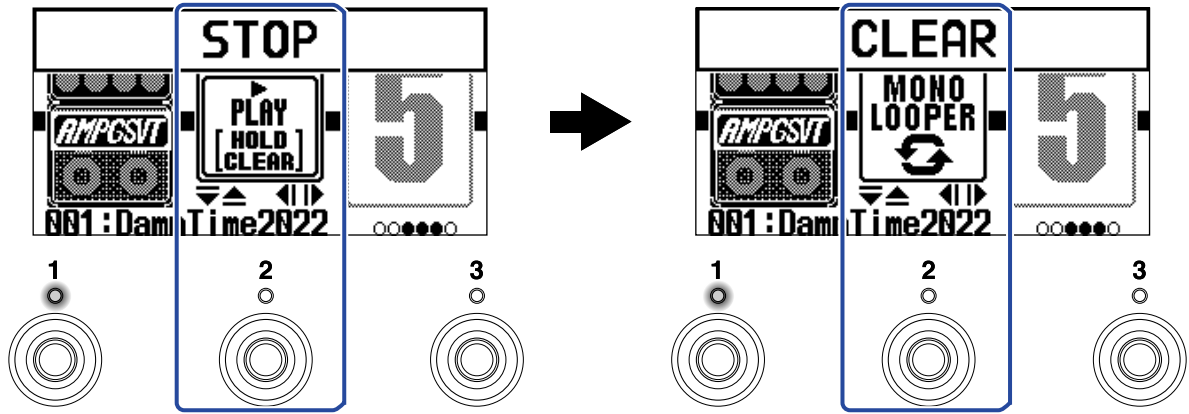

This clears the recorded loop.

# Using audio interface functions

---

The B2 FOUR can be used as a 2-in/2-out audio interface.

After being processed by effects, 2 channels of audio signals can be sent from the B2 FOUR to a computer or smartphone.

From a computer or smartphone, 2 audio signal channels can be input to a position after the effect processing.

See [Signal flow](#) for details about input and output positions.

## Installing drivers

### Windows computers

---

1. Download the B2 FOUR Driver from [zoomcorp.com](http://zoomcorp.com) to the computer.

**NOTE:**

The latest B2 FOUR Driver can be downloaded from the above website.

2. Launch the installer and follow its instructions to install the B2 FOUR Driver.

**NOTE:**

See the Installation Guide included in the driver package for detailed installation procedures.

### Mac computers, smartphones and tablets

---

No driver is necessary for use with a Mac, smartphone or tablet.

# Connecting with a computer, smartphone or tablet.

1. Use a USB cable to connect the B2 FOUR to a computer, smartphone or tablet.

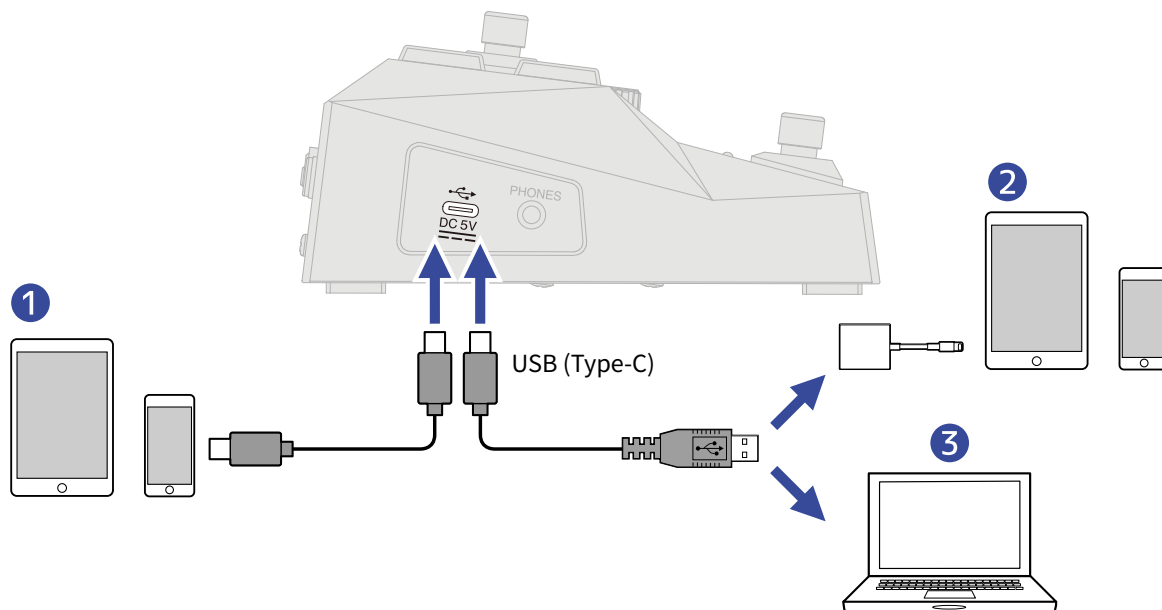

- 1 Smartphone/tablet (Android)
- 2 Smartphone/tablet (iOS/iPadOS)
- 3 Computer (Windows/Mac)

## NOTE:

- Use a USB (Type-C) cable that supports data transfer.
- Use a Lightning to USB 3 Camera Adapter to connect to an iOS/iPadOS device with a lightning connector.

2. Set  to ON.

The B2 FOUR will start up and be connected to the smartphone/tablet.  
If connecting to a computer, continue to step 3.

3. When connecting to a computer, set the B2 FOUR as the sound device.

# Operating the B2 FOUR from an iPhone/iPad

The B2 FOUR can be operated from an iPhone/iPad using Handy Guitar Lab for B2 FOUR, an iOS/iPadOS app.

**NOTE:**

The dedicated Handy Guitar Lab for B2 FOUR app must be installed on the iPhone/iPad beforehand. The Handy Guitar Lab for B2 FOUR app can be downloaded from the App Store. For setting and operation procedures using the Handy Guitar Lab for B2 FOUR app, see its operation manual.

1. Use a USB cable to connect the B2 FOUR and the iPhone/iPad.

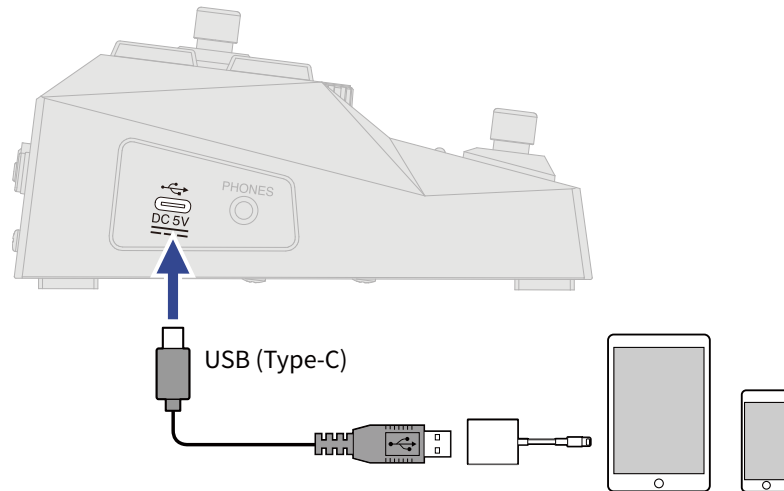

**NOTE:**

- Use a USB (Type-C) cable that supports data transfer.
- Use a Lightning to USB 3 Camera Adapter to connect to an iOS/iPadOS device with a lightning connector.

2. Set  to ON.

3. Launch Handy Guitar Lab for B2 FOUR on the iPhone/iPad.

# Making hardware settings

## Setting the AUTO SAVE function

When the AUTO SAVE function is ON, patch memories will be saved automatically when their contents are changed.

See "[Using the MENU Screen](#)" for details about operation.

1. Select AUTO SAVE on the MENU Screen.

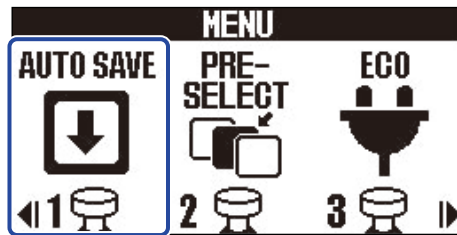

2. Press  /  to turn it ON/OFF.



Setting	Explanation
ON	This turns on the AUTO SAVE function.
OFF	This turns off the AUTO SAVE function.

3. Press  .

This confirms the setting and returns to the [MEMORY Screen](#) or [EFFECT Screen](#).

---

**HINT:**

Patch memories will not be saved automatically if the AUTO SAVE function is OFF.

When the content of a patch memory has been changed, **EDITED** will appear at the top right of the MEMORY Screen, showing that it is different from the saved settings. (→ [Copying and saving patch memories](#))





# Setting the ECO mode

This function can be used to turn the power off automatically if unused for 10 hours. See "[Using the MENU Screen](#)" for details about operation.

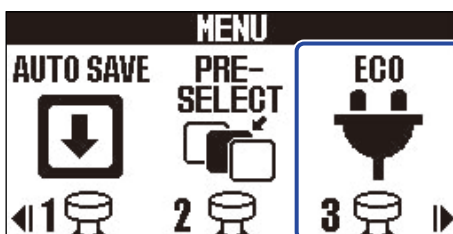
1. Select ECO on the MENU Screen.



2. Press  /  to switch between ON and OFF.

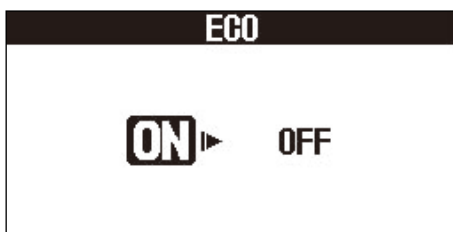

Setting	Explanation
ON	The power will automatically turn off if unused for 10 hours.
OFF	This disables ECO mode.

3. Press .

This confirms the setting and returns to the [MEMORY Screen](#) or [EFFECT Screen](#).



# Adjusting the display contrast

The display contrast can be adjusted.

See "[Using the MENU Screen](#)" for details about operation.

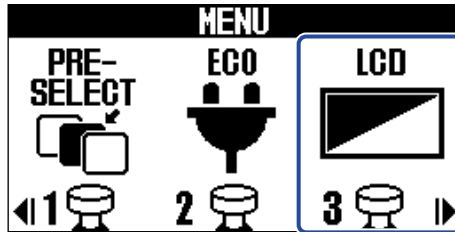
1. Select LCD on the MENU Screen.



2. Use  and  to adjust the display contrast.

The setting value is shown on the display.



3. Press .

This confirms the setting and returns to the [MEMORY Screen](#) or [EFFECT Screen](#).



# Managing the firmware

## Checking the firmware versions

The firmware versions used by the B2 FOUR can be checked. See [“Using the MENU Screen”](#) for details about operation.

1. Select VERSION on the MENU Screen.

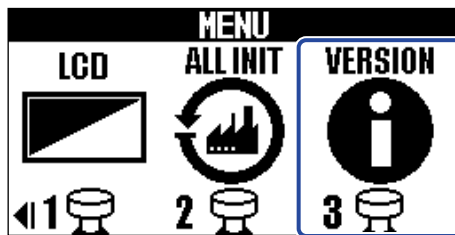

2. Check the versions on the Version Screen.  
This shows the firmware and preset versions.

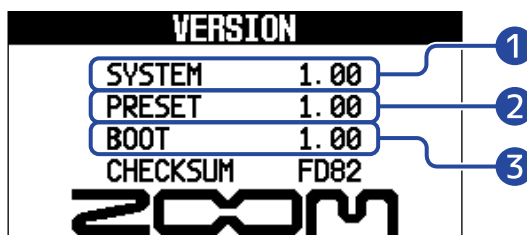

- 1 B2 FOUR firmware version
- 2 Preset version
- 3 BOOT version

## Updating

The B2 FOUR firmware can be updated to the latest versions. The latest firmware can be downloaded from the ZOOM website ([zoomcorp.com](http://zoomcorp.com)).

# Restoring factory default settings

---

The factory default settings can be restored.

See [“Using the MENU Screen”](#) for details about operation.

1. Select ALL INIT on the MENU Screen.

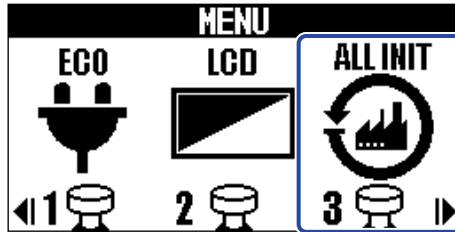

2. Use  /  to select YES.

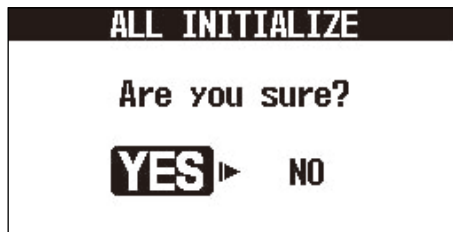

3. Press .

Initialization will be executed, restoring default settings.



## NOTE:

Initialization will overwrite all settings, including patch memories, to their factory defaults. Be certain before using this function.

## HINT:

To cancel initialization, select NO in step 2.

---

# Appendix

---

## Troubleshooting

### The unit will not power on

- Confirm that the POWER switch is ON. (→ [Turning the power on/off](#))
- Check the connections. (→ [Making connections](#))

### There is no sound or output is very quiet

- Check the connections. (→ [Making connections](#))
- Adjust the levels of the effects. (→ [Adjusting effect parameters](#))
- Adjust the output volume. (→ [Adjusting the overall tonal character and output level](#))
- If an expression pedal is being used to adjust the volume, adjust the pedal position until the volume level is suitable.

### There is a lot of noise

- Confirm that an instrument cable is not the cause.
- Use a genuine ZOOM AC adapter. (→ [Making connections](#))

### An effect cannot be selected

- If the effect processing power is being exceeded, "PROCESS OVERFLOW" will appear on the display. When "PROCESS OVERFLOW" appears for an effect, it will be bypassed. (→ [Note about the number of effects in patch memories](#))

### Expression pedal does not work well

- Select a pedal effect. (→ [Using a connected expression pedal](#))
- Check the expression pedal connection. (→ [Making connections](#))

# Specifications

Maximum number of simultaneous effects		5
User patch memories		300
A/D conversion		24-bit 128× oversampling
D/A conversion		24-bit 128× oversampling
Signal processing		32-bit
Display		256×128 dot-matrix LCD
Inputs	INPUT	Standard mono phone jack Rated input level: -20 dBu Input impedance (line): 1 or 10 MΩ (switchable)
	AUX INPUT	Stereo mini jack Rated input level: -10 dBu Input impedance (line): 10 kΩ
Outputs	LEFT/RIGHT	Standard mono phone jacks Maximum output level: +11.4 dBu (when output impedance 10 kΩ or higher)
	BALANCED OUTPUT	XLR jack Impedance: 100 Ω (HOT-GND, COLD-GND)/200 Ω (HOT-COLD) GND LIFT (switchable)
	PHONES	Stereo mini jack Maximum output power: 33 mW + 33 mW (into 32Ω load)
Input S/N		124 dB
Noise floor (residual noise)	LEFT/RIGHT	-96.0 dBu
	BALANCED OUTPUT	-100.0 dBu
	PHONES	-96.0 dBu
Control input		FP02M input
Power		AC adapter: 9V DC 500mA center negative (ZOOM AD-16)
USB		USB 2.0 Type-C port (use cable that supports Type-C) Handy Guitar Lab: USB 1.1 Full Speed Audio interface: USB 2.0 Full Speed, 32-bit, 2-in/2-out • Use a USB cable that supports data transfer. USB bus power is supported.
Dimensions		146 mm (D) × 249 mm (W) × 72 mm (H)
Weight		906 g

Note: 0 dBu = 0.775 V



ZOOM CORPORATION

4-4-3 Kanda-surugadai, Chiyoda-ku, Tokyo 101-0062 Japan

[zoomcorp.com](https://zoomcorp.com)