

A1 FOUR / A1X FOUR

Multi-Effects Processor

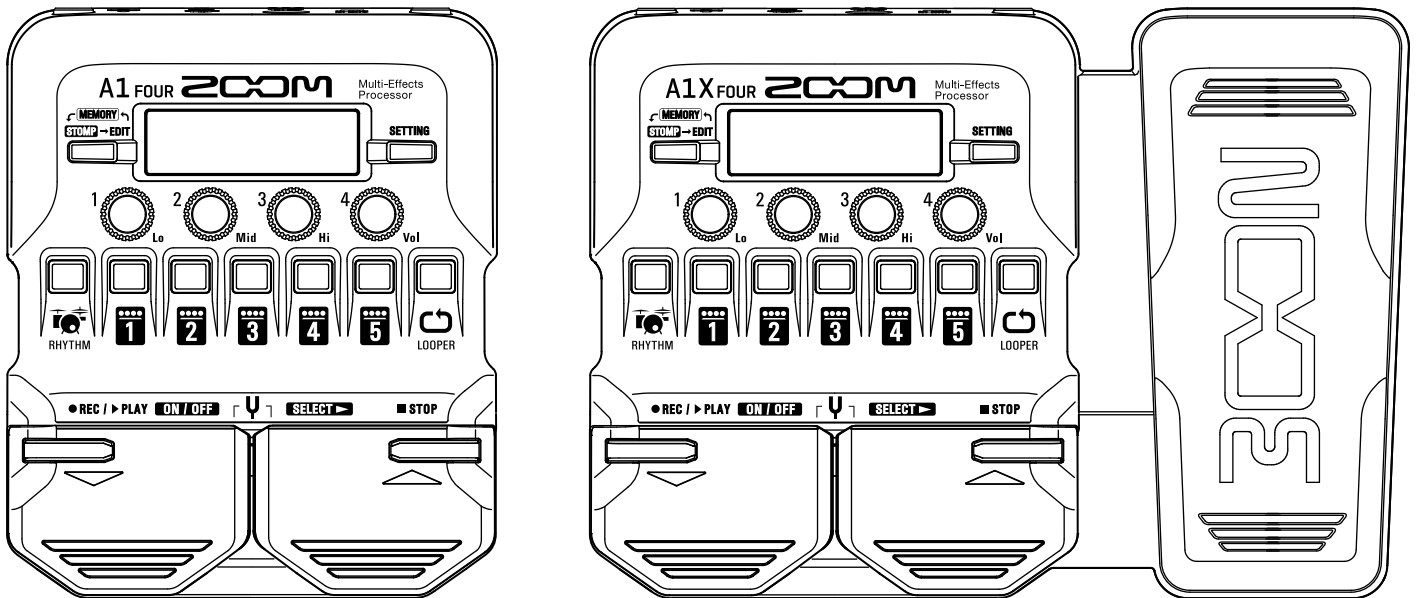

Operation Manual

You must read the Usage and Safety Precautions before use.

© 2019 ZOOM CORPORATION

Copying or reprinting this manual in part or in whole without permission is prohibited.

Product names, registered trademarks and company names in this document are the property of their respective companies. All trademarks and registered trademarks in this document are for identification purposes only and are not intended to infringe on the copyrights of their respective owners.

Introduction

Thank you very much for purchasing a ZOOM **A1_{FOUR}/A1X_{FOUR}** Multi-Effects Processor.

This multi-effect processor has a variety of effects, including reverb, chorus and distortion, that can be used in combination to alter the sound. Effect combinations and parameter settings can be saved as patch memories to be recalled and used whenever you like. First, try switching through the preset patch memories to experience how they affect the sound.

Understanding the features of each effect is important for making the most of them and designing your own sounds. By turning off the effects in a preset patch memory one at a time, you should be able to quickly learn their roles. If understanding how a sound is being changed is difficult, try turning off all but one of the effects and adjusting its parameters as you play. The order of the effects also impacts the sound. Experimenting with the effect order could bring you closer to your desired sound.

This Multi-Effects Processor allows you to easily enjoy a variety of sounds. We hope you will enjoy using it for many years.

Main features of the **A1_{FOUR}/A1X_{FOUR}**

Craft sounds intuitively with easy operations

Quick intuitive sound creation is possible with operation just like a compact effect/stomp box.

MAA-1 mic adapter

The effects can also be applied to an acoustic instrument by connecting a mic with an XLR connector using the MAA-1. Moreover, phantom power (+48V) can be supplied, allowing use with clip-on mics and other condenser microphones.

Effect sounds that are optimized for use with acoustic instruments

In addition to core effects from our most recent G Series, this processor includes well-regarded acoustic guitar effects from our AC Series as well as effects optimized for a variety of acoustic instruments. Performance using effects is possible free of worry about feedback by using the anti-feedback effect. Moreover, using the free Guitar Lab effect management application on a computer (Mac/Windows), you can add effects that are distributed online as well as edit and back up patch memories, for example.

Rhythm patterns with great versatility

Simple rhythm patterns that can be used with a variety of genres are built in.

30-second looper

Sound-on-sound performance is possible using the looper capable of recording up to 30 seconds. Moreover, this is convenient when using acoustic instruments that are loud unamplified because putting the looper at the beginning of the effect chain allows sound to be played once, then looped and manipulated without additional playing.

Equalization (EQ) can be quickly adjusted to suit performance conditions

In MEMORY and STOMP modes, 3 EQ (Lo/Mid/Hi) knobs and a volume (Vol) knob can be used to adjust the output. These enable quick adjustments even if the performance environment changes.

Long operation on batteries

Continuous operation for about 18 hours is possible using 4 AA batteries (when the LCD backlight is off).

Terms used in this manual

Patch memory

A “patch memory” stores effect ON/OFF states and parameter setting values. Effects are saved and recalled in units of patch memories. Five effects can be added to one patch memory, and the A1_{FOUR}/A1X_{FOUR} can store up to 50 patch memories.

Bank

One group of 10 patch memories is a “bank.” Patch memories can be quickly recalled by switching banks. The A1_{FOUR}/A1X_{FOUR} has 5 banks.

Effect type

Effect types cover a variety of effects, including reverb, chorus and distortion. Effects can be selected from these types to be added to patch memories.

MEMORY mode

Use this mode to select patch memories with the footswitches.

STOMP mode

Use this mode to turn effects in a patch memory on and off with the footswitches.

EDIT mode

In this mode, edit the types and parameters and effects used in a patch memory.

PRESELECT

This function allows you to switch to a patch memory at any location while continuing to use the tone of the currently selected patch memory.

BANK HOLD

This function allows patch memory switching to be limited to the current bank.

AUTO SAVE

This function automatically saves changes to patch memories and effect settings.

ECO mode

This function will automatically turn the power off 10 hours after the last operation.

Anti-feedback

This function can detect and cut the frequency band that is feeding back to reduce it.

Contents

Introduction	2	Making power and display settings	37
Terms used in this manual	3	Setting the type of batteries used	37
Contents	4	Setting the ECO mode	38
A1_{FOUR}/A1X_{FOUR} structure	5	Setting the backlight time	39
Names of parts	7	Adjusting the display contrast	40
Loading batteries	9	Using the tuner	41
Connecting	10	Activating the tuner	41
Connecting a mic using the MAA-1	11	Tuning instruments	41
Adjusting the overall audio character and output level	13	Changing tuner settings	43
Using patch memories (MEMORY mode)	14	Preventing feedback	45
Switching to MEMORY mode.	14	Using rhythms	46
Selecting patch memories and banks	15	Activating the rhythm function	46
Changing individual patch memory settings	16	Setting the rhythm	47
Turning effects ON/OFF with footswitches (STOMP mode)	18	Starting/stopping rhythm playback	48
Activating STOMP mode	18	Rhythm patterns	49
Turning effects ON/OFF with footswitches ...	19	Using the looper	50
Editing effects (EDIT mode)	20	Activating the looper.....	50
Activating EDIT mode	20	Setting the looper	51
Selecting effects	21	Recording and playing loops	53
Turning effects ON/OFF.....	21	Overdubbing loops	54
Changing effect types	22	Clearing the loop	55
Adjusting effect parameters	23	Using the expression pedal (A1X_{FOUR} only) ...	56
Changing the effect order	24	Setting pedal effects	56
Managing patch memories	25	Adjusting the pedal	57
Saving patch memories	25	Managing the firmware	59
Swapping patch memories	27	Checking the firmware versions	59
Adjusting the master tempo	29	Updating the firmware	60
Setting the AUTO SAVE function	30	Restoring factory default settings	61
Setting the PRESELECT function	33	Troubleshooting	62
Setting the BANK HOLD function	36	Specifications	63

A1 FOUR/A1X FOUR structure

■ Signal flow

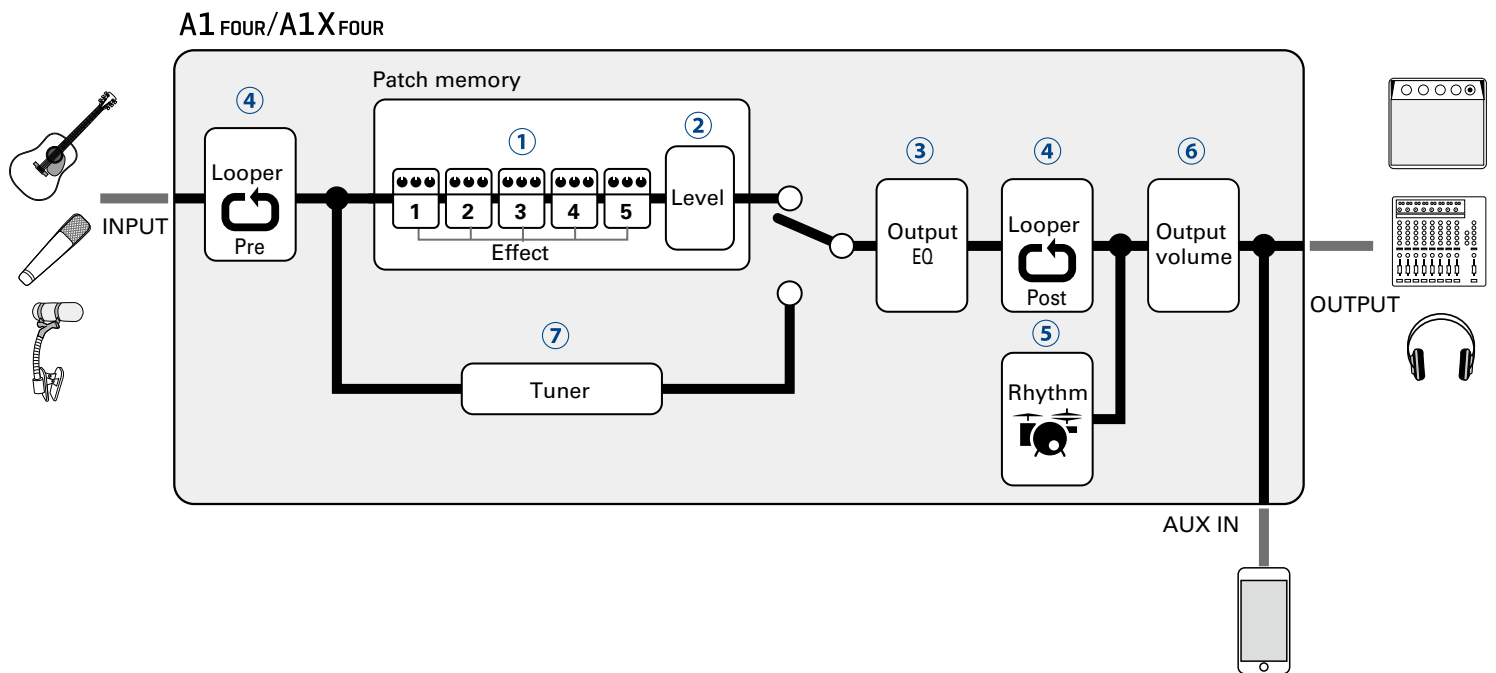

① The input instrument sound passes through effects 1 – 5 in order.

(→ [“Using patch memories \(MEMORY mode\)” on page 14](#))

② The patch memory level is adjusted.

(→ [“Using patch memories \(MEMORY mode\)” on page 14](#))

③ The overall sound is adjusted. This setting is retained even when the patch memory is changed.

(→ [“Adjusting the overall audio character and output level” on page 13](#))

④ Recorded phrases can be played back in a loop. The looper can be set to before (Pre) or after (Post) the effects and EQ.

(→ [“Using the looper” on page 50](#))

⑤ Drum sounds can be played back using built-in rhythm patterns.

(→ [“Using rhythms” on page 46](#))

⑥ The overall level is adjusted.

(→ [“Adjusting the overall audio character and output level” on page 13](#))

⑦ This function enables tuning the connected instrument.

(→ [“Using the tuner” on page 41](#))

■ Memory overview (patch memories/banks)

The **A1 FOUR/A1X FOUR** can save up to 50 patch memories. Patch memories are managed in banks of 10.

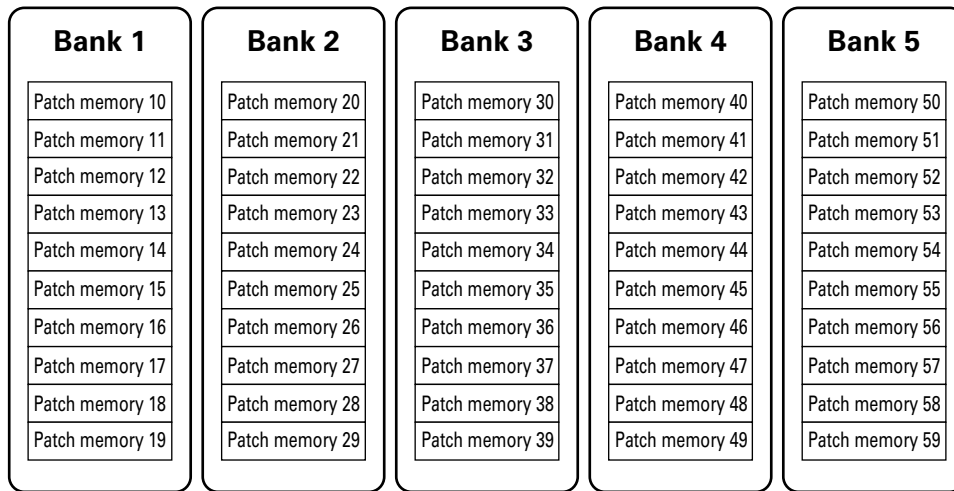

■ Operation modes

The **A1 FOUR/A1X FOUR** has three operation modes that can be used as needed while performing.

• MEMORY mode

Use to select patch memories for performance.

(→ [“Using patch memories \(MEMORY mode\)”](#) on page 14)

• STOMP mode

Use this to turn effects in a patch memory ON/OFF with the footswitches.

(→ [“Turning effects ON/OFF with footswitches \(STOMP mode\)”](#) on page 18)

• EDIT mode

Use this to change the effects used in a patch memory and to edit effect parameters.

(→ [“Editing effects \(EDIT mode\)”](#) on page 20)

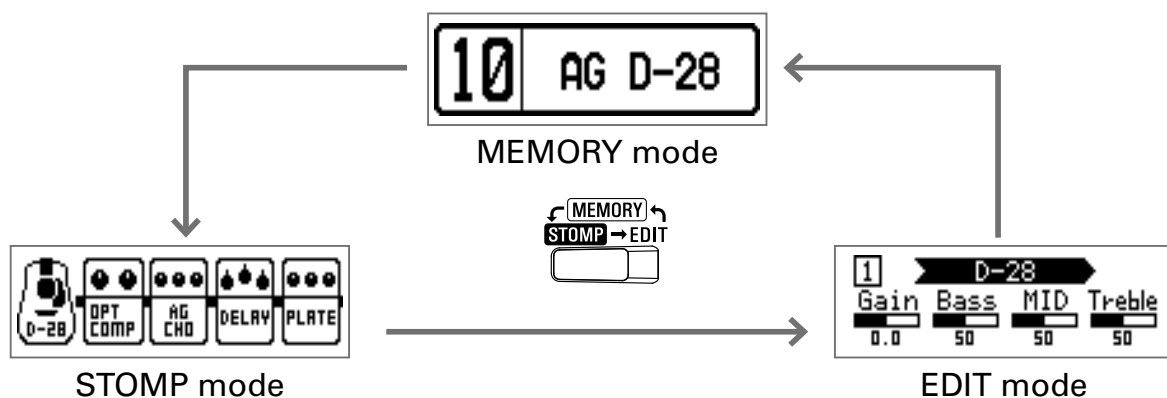

Names of parts

■ Front Panel

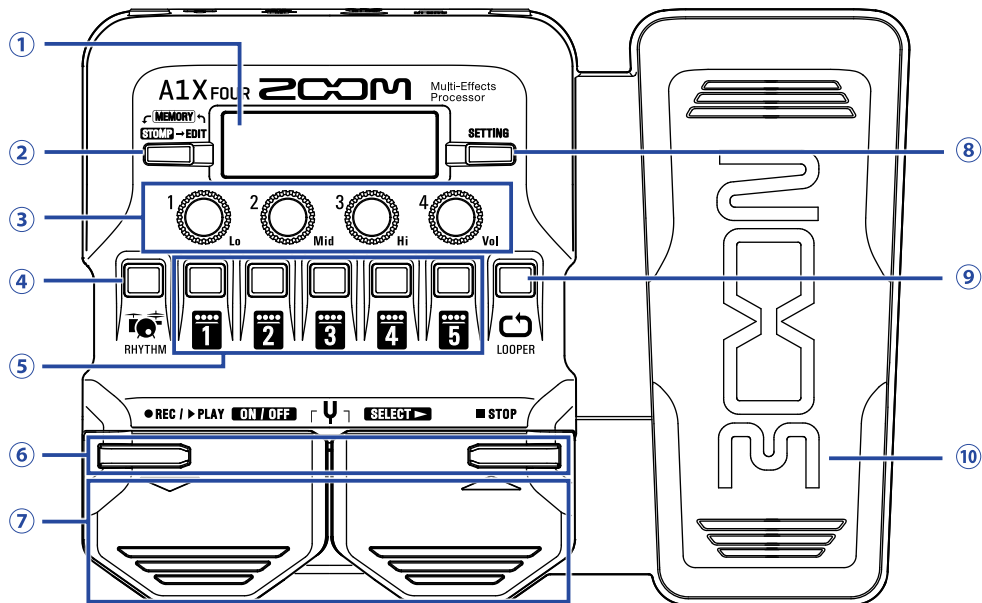

① Display

This shows information, including the names of the selected patch memory and its effects and their parameter values

② Mode switch

Press this to cycle through the MEMORY, STOMP and EDIT modes.

③ Parameter knobs

Use these to adjust effect parameters and to make various settings.

④ RHYTHM button

Press to activate the rhythm.

⑤ Effect/bank buttons

In MEMORY mode, these change banks.

In STOMP mode, these turn effects ON/OFF.

In EDIT mode, these select effects and turn them ON/OFF.

⑥ ▼/▲ buttons

Use these to switch effects in EDIT mode. These have the same functions as the ▼/▲ footswitches.

⑦ ▼/▲ footswitches

In MEMORY mode, use these to switch patch memories. In STOMP mode, use these to select effects and turn them ON/OFF, for example.

⑧ SETTING button

This opens the SETTING screen.

⑨ LOOPER button

Press to activate the looper.

⑩ Expression pedal (A1X_{FOUR} only)

When an effect in the PEDAL category is selected, this adjusts the amount of that effect. (→ [“Setting pedal effects”](#) on page 56)

■ Rear Panel

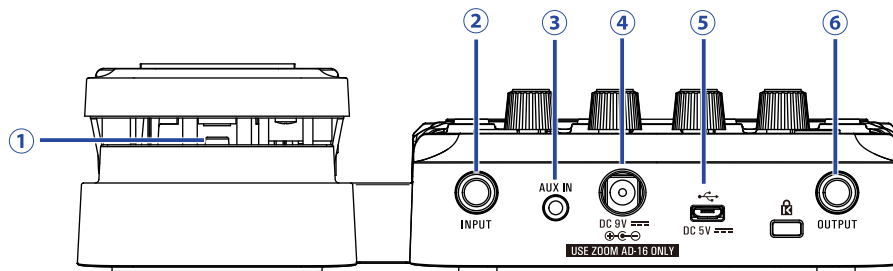

① Pedal switch (A1X_{FOUR} only)

When an effect in the PEDAL category is in use, this turns that effect ON/OFF.

② Input jack

Connect an instrument here.

③ AUX IN jack

Connect an audio device or other external sound source here.

HINT

Signals input through the AUX IN jack will be sent to the OUTPUT jack directly without passing through the built-in effects.

④ AC adapter connector

Connect the dedicated AC adapter (ZOOM AD-16) here.

⑤ USB port

Connect a computer or other external device here. By using Guitar Lab, you can manage patch memories and edit and add effects, for example, from a computer.

You can also connect a mobile battery, for example, to provide power.

⑥ OUTPUT jack

Connect a PA system or headphones here.

Loading batteries

1. Open the battery compartment cover on the bottom of the product and insert 4 AA batteries.

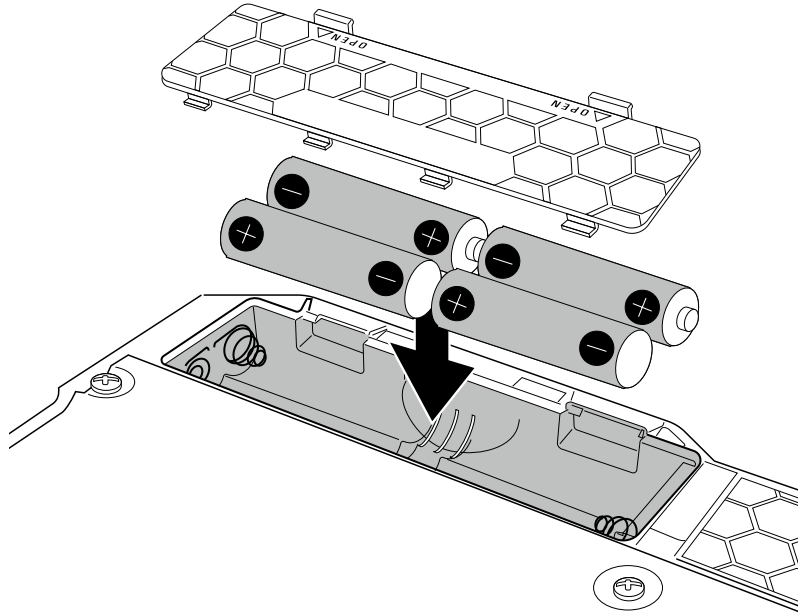

2. Close the battery compartment cover.

NOTE

Set the type of battery used correctly so that the amount of remaining battery charge can be shown accurately. (→ [“Setting the type of batteries used” on page 37](#))

HINT

- If a dedicated AC adapter (ZOOM AD-16) is connected, it can run on AC power.
- Power for operation can also be supplied through the USB port.

ECO mode overview

- By default, ECO mode setting is ON, so the power will automatically turn off if no use occurs for 10 hours.
- ECO mode can also be set to “OFF” on the SETTING screen. (→ [“Setting the ECO mode” on page 38](#))

Connecting

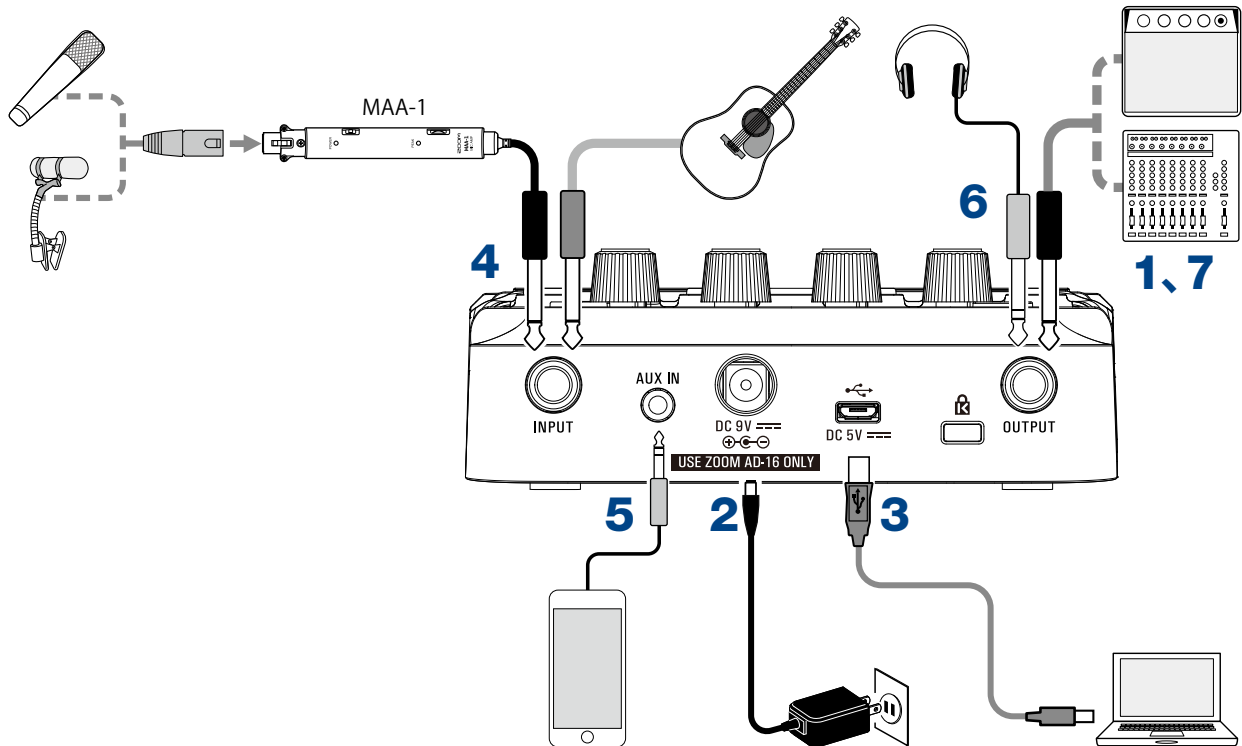

1. Minimize the volume of the output device.
2. To use AC power supply, connect the dedicated AC adapter (ZOOM AD-16) to the AC adapter jack and an outlet.
This turns the **A1 FOUR/A1X FOUR** power ON.
3. To use a computer, connect a USB cable (not included) to the USB port and the computer.
When using USB bus power to operate the **A1 FOUR/A1X FOUR**, connecting this cable will turn it ON.

Guitar Lab

By using Guitar Lab, you can manage patch memories and edit and add effects, for example, from a computer.

Download Guitar Lab from the ZOOM website (www.zoom.co.jp/).

4. Connect an instrument to the INPUT jack.
When using battery power to operate the **A1 FOUR/A1X FOUR**, connecting to this will turn it ON.
Use the MAA-1 to connect a mic. (→ [“Connecting a mic using the MAA-1” on page 11](#))
5. To use external input, connect a portable audio player or other device to the AUX IN jack.

HINT

Signals input through the AUX IN jack will be sent to the OUTPUT jack directly without passing through the built-in effects.

6. Connect a PA system or headphones to the OUTPUT jack.
7. Raise the output device volume.

Connecting a mic using the MAA-1

Using the MAA-1 to connect a mic to the **A1_{FOUR}**/**A1X_{FOUR}**, it can be enjoyed with instruments that do not have pickups, including harmonicas, violins, trumpets, saxophones and other string and brass instruments.

Putting batteries into the MAA-1

1. Press and slide the battery compartment cover down to open it.

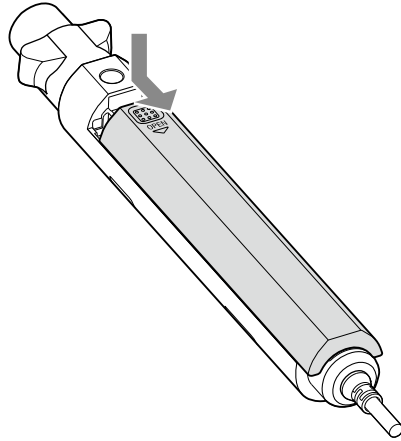

2. Insert 2 AA batteries.

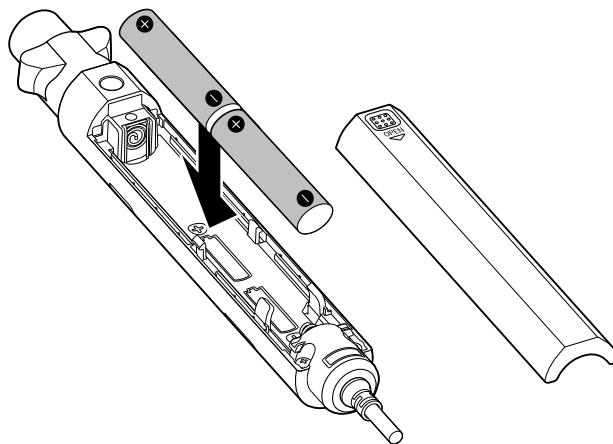

3. Close the battery compartment cover.

Turn the MAA-1 power on.

1. Set  to the ON position.

POWER  will light red.

When connecting a condenser mic or other device that requires phantom power, set it to the +48V position.

NOTE

When connecting devices that are not compatible with phantom power, do not set  to +48V. Doing so could damage the device.

Adjusting the MAA-1 input level

1. Turn .

Adjust so that  ^{PEAK} lights green.

If the input level is too high,  ^{PEAK} will light red.

Adjusting the overall audio character and output level

1. In MEMORY or STOMP mode, turn 1 Lo – 4 Vol .

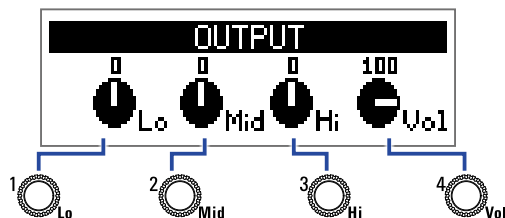

Function	Operation
Adjust the level of low frequencies	Turn 1 Lo
Adjust the level of middle frequencies	Turn 2 Mid
Adjust the level of high frequencies	Turn 3 Hi
Adjust the overall level	Turn 4 Vol

HINT

These adjustments are retained even when the patch memory is changed.

Using patch memories (MEMORY mode)

The **A1_{FOUR}**/**A1X_{FOUR}** manages effects in patch memories. A patch memory can have up to five effects and save their ON/OFF states and parameter settings.

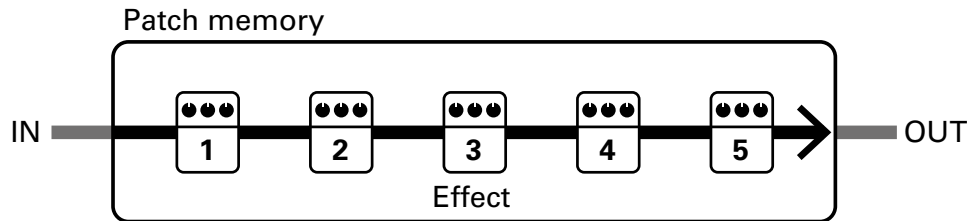

Up to 50 patch memories can be created. Groups of 10 patch memories are organized into banks, so effects can be quickly recalled by switching banks.

Select patch memories to use in MEMORY mode.

Switching to MEMORY mode.

HINT

MEMORY mode is shown when the **A1_{FOUR}**/**A1X_{FOUR}** starts up.

1. When using STOMP or EDIT mode, press .

Pressing  repeatedly, cycles through the MEMORY, STOMP and EDIT modes in order.





Selecting patch memories and banks

Switching patch memories

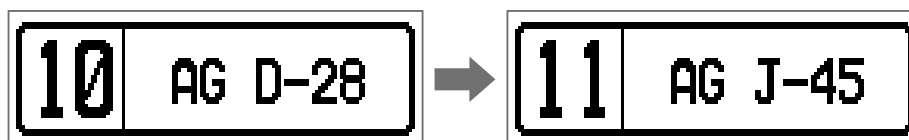

1. Press  or .

This changes the patch memory.



Function	Operation
Switch to lower-numbered patch memory	Press 
Switch to higher-numbered patch memory	Press 

HINT





- By continuing to press  or , you can continuously switch patch memories.
- By using the PRESELECT function, you can switch to a patch memory at any location while continuing to use the tone of the currently selected patch memory. (→ [“Setting the PRESELECT function” on page 33](#))
- When using the BANK HOLD function, switching is limited to patch memories in the same bank. (→ [“Setting the BANK HOLD function” on page 36](#))

Switching banks

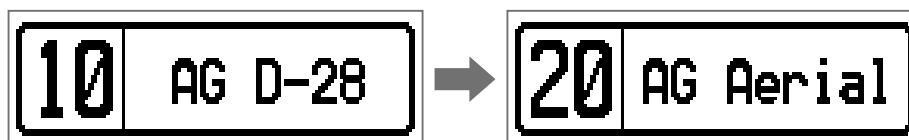
1. Press  – .

This changes the bank. The LED for the selected bank lights.



Function	Operation
Switch to patch memory numbers 10 – 19	Press 
Switch to patch memory numbers 20 – 29	Press 
Switch to patch memory numbers 30 – 39	Press 
Switch to patch memory numbers 40 – 49	Press 
Switch to patch memory numbers 50 – 59	Press 

Changing individual patch memory settings

1. Select the patch memory with settings you want to change.



2. Press .

This opens the SETTING screen.

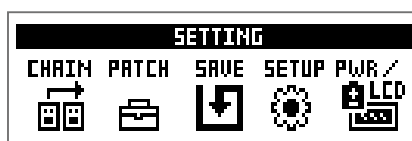

3. Press .

This opens the patch memory setting screen.

The patch memory level and name can be changed. (→ [“Changing patch memory levels”](#) on page 16, [“Changing patch memory names”](#) on page 17)

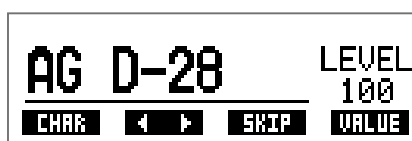

Changing patch memory levels

1. Turn .

This changes the patch memory level.



HINT

- Press  to end patch memory setting and return to the original screen.
- In addition to settings for individual patch memories, the overall volume and EQ of the **A1 FOUR/A1X FOUR** can also be changed. (→ [“Adjusting the overall audio character and output level”](#) on page 13)

Changing patch memory names

1. Turn ²○_{Mid}.

This moves the cursor.



2. Turn ¹○_{Lo}.

This changes the character at the cursor position.



HINT

- Press ^{SETTING} to end patch memory setting and return to the original screen.
 - The characters and symbols that can be used are as follows.
A-Z, a-z, 0-9, ! # \$ % & ' () +, -, . ; = @ [] ^ _ ` { } ~ (space)
 - Turn ³○_{Hi} to change the character type.
-

Turning effects ON/OFF with footswitches (STOMP mode)

In STOMP mode, you can turn effects ON/OFF with footswitches.

Activating STOMP mode

1. When using MEMORY or EDIT mode, press .

Pressing  repeatedly, cycles through the MEMORY, STOMP and EDIT modes in order.

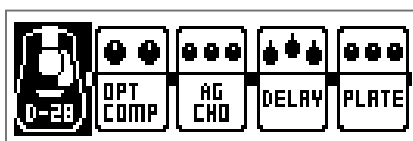



Turning effects ON/OFF with footswitches

1. Press .

Select the effect to control.

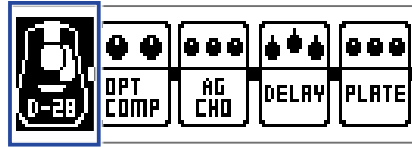
The selected effect is shown with light and dark inverted.



Press  repeatedly to move the selection to the right.

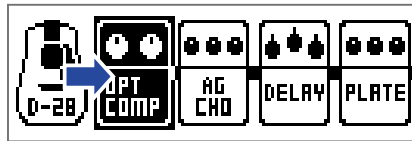

2. Press .

This turns the effect ON/OFF.

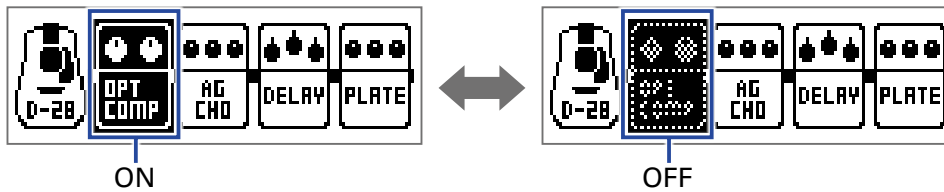

To turn an effect ON/OFF by hand, press the  -  button that corresponds to the effect position.

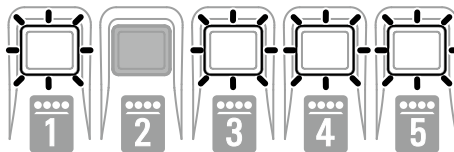
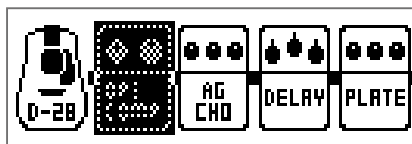

Editing effects (EDIT mode)

In EDIT mode, you can change the effects used in patch memories and adjust their parameters.

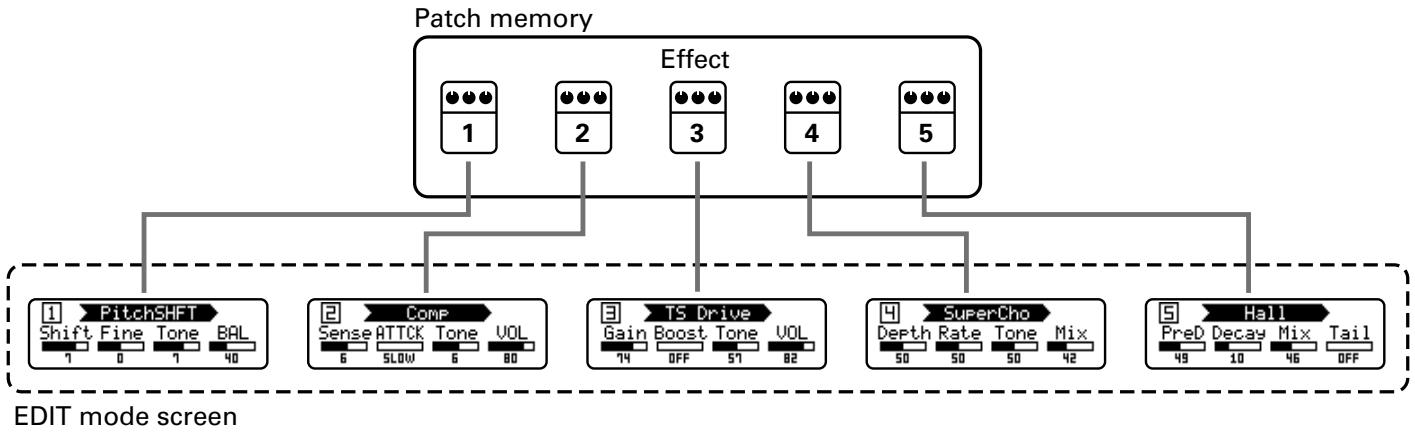

Activating EDIT mode

1. Select a patch memory in MEMORY mode.



2. Press .

Pressing  repeatedly, cycles through the MEMORY, STOMP and EDIT modes in order.



Selecting effects

1. Press **1** – **5** for the effect you want to edit.

This switches the effect.

The LED for the selected effect lights.

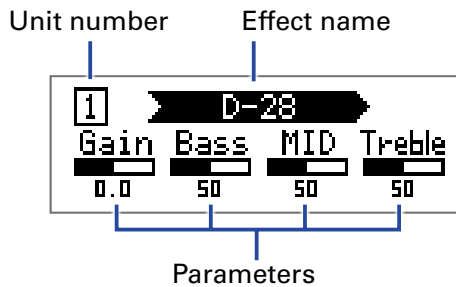

HINT

The effect unit number is its position in the patch memory order.

Turning effects ON/OFF

1. Press the **1** – **5** for the selected effect again.

Pressing **1** – **5** toggles it ON/OFF.

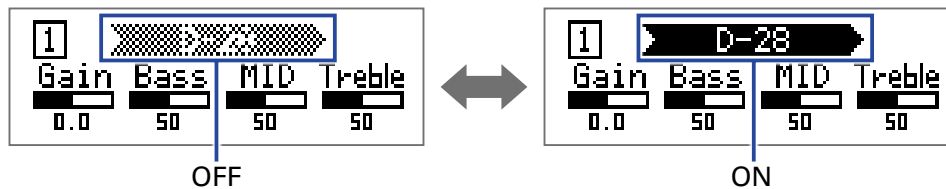



Changing effect types

Selecting effect types

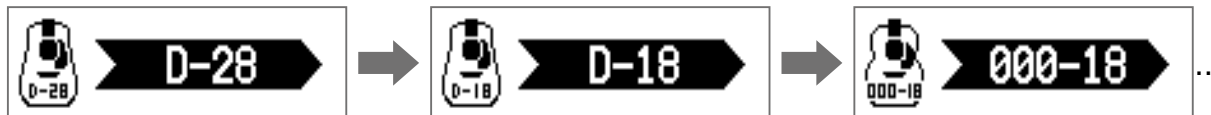
1. Press  or .



Function	Operation
Change to the previous effect type	Press 
Change to the next effect type	Press 

Selecting effect categories

1. While pressing , press .

The category name appears on the display.



Press  again to show the next category name.

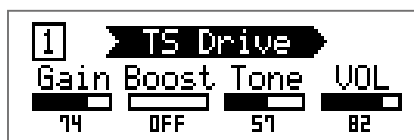

After the category name has been shown for a moment, the effect will change to the first effect in the category.



HINT

- While pressing , press  to show the previous category name.
- See Guitar Lab for the explanations of each effect.

NOTE

In the following cases, "PROCESS OVERFLOW" will appear and the effect will be bypassed. Bypassing can be ended by deleting some effects or changing their types.

- When the processing power limit is exceeded
- When trying to use 3 or more effects that have 5 or more parameters



HINT

Select effects in the PEDAL category on the **A1X FOUR** to use effects that can be controlled by the expression pedal.

Adjusting effect parameters

1. Turn ¹Lo - ⁴Vol.

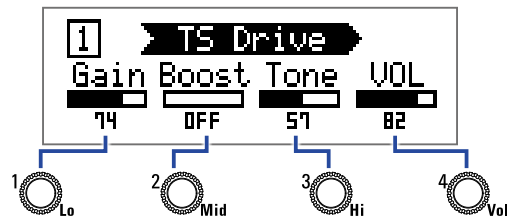

The parameters assigned to each knob depend on the effect. Refer to the names shown on the display.

If an effect has 5 or more parameters, use ⁴Vol to change the screen.

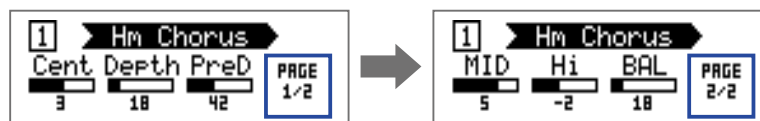

HINT

- When AUTO SAVE is set to ON, parameter changes will be saved automatically. (→ [“Setting the AUTO SAVE function” on page 30](#))
- When AUTO SAVE is set to OFF, a parameter saving screen will appear when you try to change patch memories.
- The AUTO SAVE function is on by default.

Changing the effect order

1. Press **SETTING**.

This opens the SETTING screen.



2. Press **1**.

This opens the CHAIN screen.

The effects used in the selected patch memory are shown as icons.

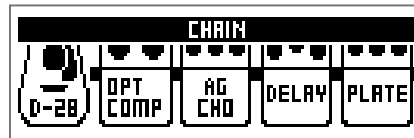

3. Press the **1** - **5** button for the effect you want to move.

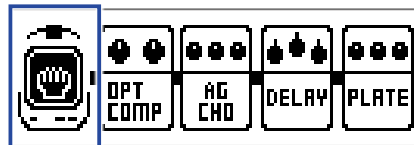

4. Press the **1** - **5** button for the destination position.

The effect will be moved to the selected destination.

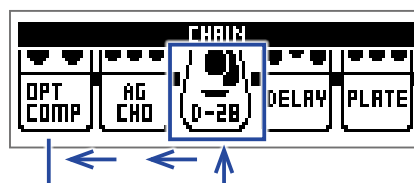

Managing patch memories

Saving patch memories

Patch changes can be saved to the same patch memory, overwriting it. They can also be saved to a patch memory with a different number.

1. Press .

This opens the SETTING screen.

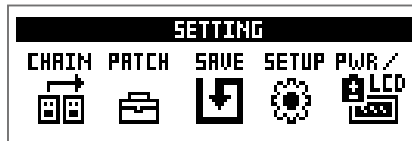

2. Press .







This opens the SAVE screen.

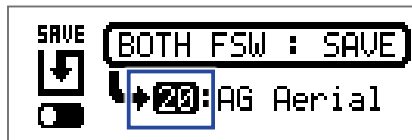

3. Use ,  and  - .

Select the destination patch memory number.



Function	Operation
Select previous patch memory	Press 
Select next patch memory	Press 
Select patch memory numbers 10 – 19	Press 
Select patch memory numbers 20 – 29	Press 
Select patch memory numbers 30 – 39	Press 
Select patch memory numbers 40 – 49	Press 
Select patch memory numbers 50 – 59	Press 

4. Press  and  at the same time.

This saves the patch memory, overwriting the content.



Swapping patch memories

The contents of the patch memory can be switched with a patch memory at a different number.

1. Press .

This opens the SETTING screen.

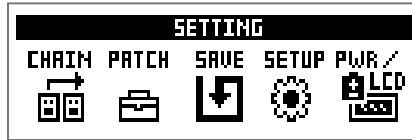

2. Press .

This opens the SAVE screen.

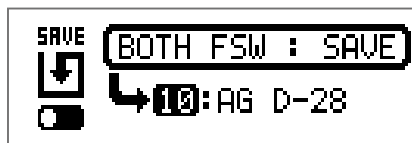

3. Turn .



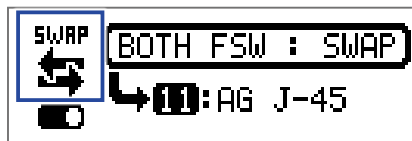



The icon on the display changes from SAVE to SWAP.

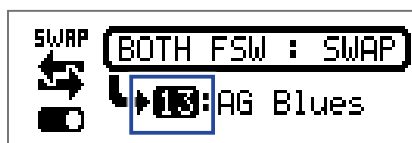

4. Use ,  and  - .

Select the number of the patch memory to swap.



Function	Operation
Select previous patch memory	Press 
Select next patch memory	Press 
Select patch memory numbers 10 – 19	Press 
Select patch memory numbers 20 – 29	Press 
Select patch memory numbers 30 – 39	Press 
Select patch memory numbers 40 – 49	Press 
Select patch memory numbers 50 – 59	Press 

5. Press  and  at the same time.

This swaps the patch memories.



NOTE

A patch memory that has been edited must be saved before it can be swapped.
Save the patch memory before trying to swap it. (→ [“Saving patch memories” on page 25](#))

Adjusting the master tempo

The master tempo is the tempo shared by effects, rhythms and the looper.

1. Press **SETTING**.

This opens the SETTING screen.

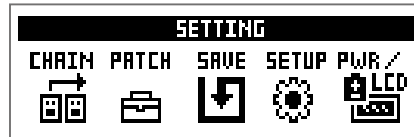

2. Press **4**.

This opens the SETUP screen.

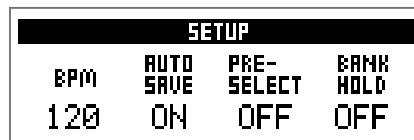

3. Turn **10**.

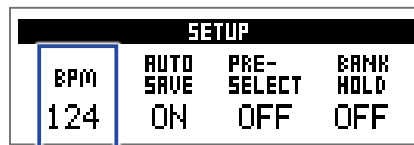

HINT

- This can be set from 40 to 250.
 - BPM (Beats Per Minute) is the number of beats (quarter notes) in one minute and is a unit used to show how fast a musical tempo is. For example, 60 BPM is a tempo of 60 beats per minute.
-

Setting the AUTO SAVE function

This function can be used to automatically save changes to patch memory and effect settings when they are made.

1. Press .

This opens the SETTING screen.

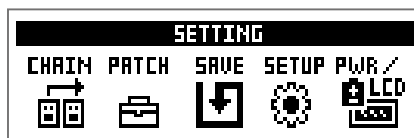

2. Press .

This opens the SETUP screen.

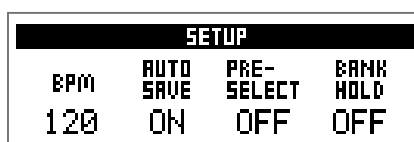

3. Turn .

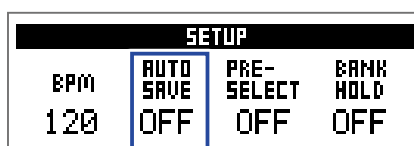

Setting	Explanation
ON	Automatic saving is enabled.
OFF	Automatic saving is disabled.

■ When AUTO SAVE is ON

Patch memory and effect setting changes will be saved automatically.

■ When AUTO SAVE is OFF

Patch memory changes can be saved with the following procedure.

1. After editing a patch memory, switch to a different patch.

A message confirming that you want to save the changes will appear on the display.

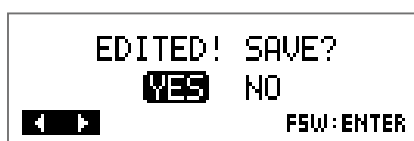

2. Turn .

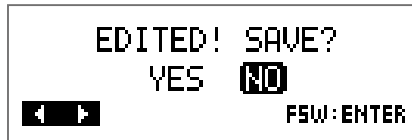

Setting	Explanation
YES	Changes will be saved.
NO	Changes will not be saved.

NOTE

If you select "NO", the other patch memory will open without saving the changed patch memory settings.

3. Press  or .







This opens a screen for selecting the patch memory number to use for saving.

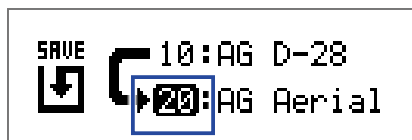

4. Use ,  and  - .

Select the destination patch memory number.



Function	Operation
Switch to lower-numbered patch memory	Press 
Switch to higher-numbered patch memory	Press 
Switch to patch memory numbers 10 – 19	Press 
Switch to patch memory numbers 20 – 29	Press 
Switch to patch memory numbers 30 – 39	Press 
Switch to patch memory numbers 40 – 49	Press 
Switch to patch memory numbers 50 – 59	Press 

5. Press  and  at the same time.

The edited patch memory is saved.



HINT

An edited patch memory can also be saved on the SETTING screen. (→ [“Saving patch memories” on page 25](#))

Setting the PRESELECT function

This function can be used to switch to a patch memory at any location while continuing to use the tone of the currently selected patch memory.

1. Press .

This opens the SETTING screen.

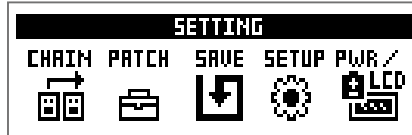

2. Press .

This opens the SETUP screen.

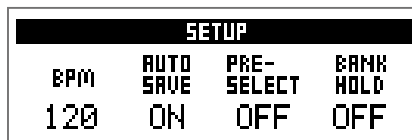

3. Turn .

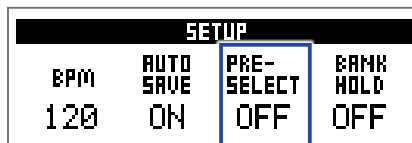







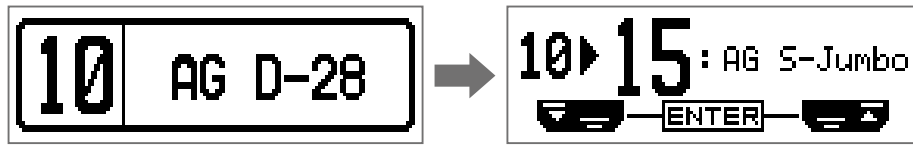

Setting	Explanation
ON	Use the PRESELECT function.
OFF	Do not use the PRESELECT function.

■ When PRESELECT is ON

1. In MEMORY mode, use ,  and  – .

This opens a screen for selecting the number of the preselect destination patch memory.



Function	Operation
Switch to lower-numbered patch memory	Press 
Switch to higher-numbered patch memory	Press 
Switch to patch memory numbers 10 – 19	Press 
Switch to patch memory numbers 20 – 29	Press 
Switch to patch memory numbers 30 – 39	Press 
Switch to patch memory numbers 40 – 49	Press 
Switch to patch memory numbers 50 – 59	Press 

2. Press  and  at the same time.

This switches to the selected patch memory.







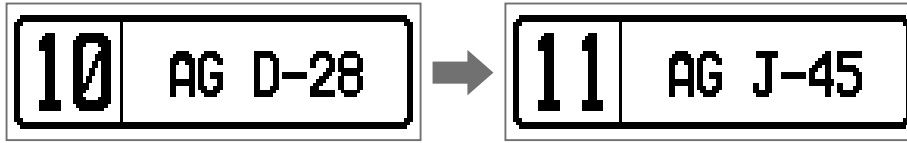

■ When PRESELECT is OFF

1. In MEMORY mode, use ,  and  – .

This changes the patch memory.



Function	Operation
Switch to lower-numbered patch memory	Press 
Switch to higher-numbered patch memory	Press 
Switch to patch memory numbers 10 – 19	Press 
Switch to patch memory numbers 20 – 29	Press 
Switch to patch memory numbers 30 – 39	Press 
Switch to patch memory numbers 40 – 49	Press 
Switch to patch memory numbers 50 – 59	Press 

Setting the BANK HOLD function

This function can be used to limit to the same bank when switching patch memories.

1. Press .

This opens the SETTING screen.

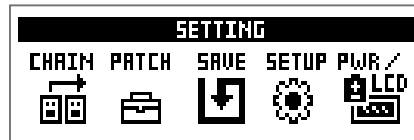

2. Press .

This opens the SETUP screen.

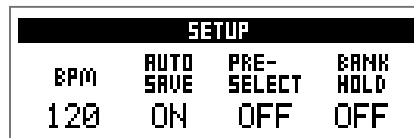

3. Turn  Vol.

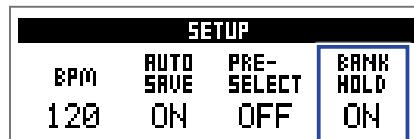

■ When BANK HOLD is ON

Switching down from the lowest patch memory in a bank will open the highest patch memory in the same bank. Switching up from the highest patch memory in a bank will open the lowest patch memory in the same bank.

Example: current patch memory in Bank 1



■ When BANK HOLD is OFF

Switching down from the lowest patch memory in a bank and up from the highest patch memory in a bank will open a patch memory in the next bank.

Example: current patch memory in Bank 1



Making power and display settings

Setting the type of batteries used

Set the type of battery used correctly so that the amount of remaining battery charge can be shown accurately.

1. Press .

This opens the SETTING screen.

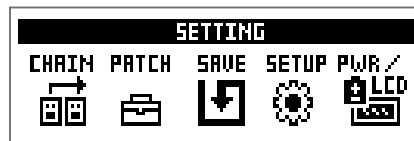

2. Press .

This opens the PWR/LCD screen.

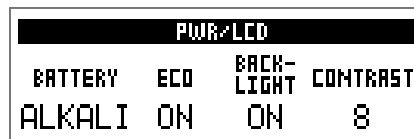

3. Turn .

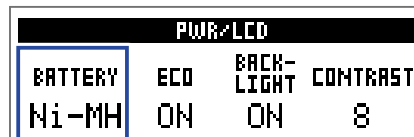

Setting	Explanation
ALKALI	Alkaline batteries
Ni-MH	Nickel-metal hydride batteries

Setting the ECO mode

This function can be used to turn the power off automatically if unused for 10 hours.

1. Press .

This opens the SETTING screen.

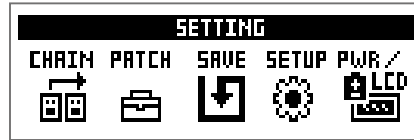

2. Press .

This opens the PWR/LCD screen.

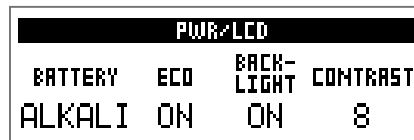

3. Turn .

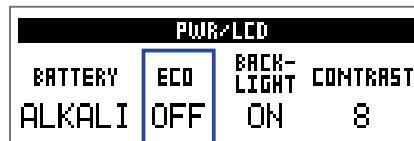

Setting	Explanation
ON	The power will automatically turn off if unused for 10 hours.
OFF	This disables ECO mode.

Setting the backlight time

1. Press **SETTING**.

This opens the SETTING screen.



2. Press **5**.

This opens the PWR/LCD screen.

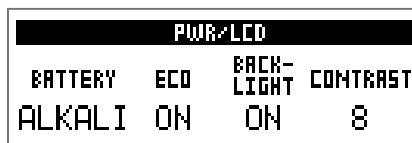

3. Turn **3** .

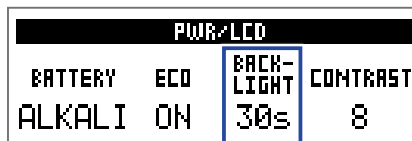

Setting	Explanation
OFF	The backlight stays off.
ON	The backlight stays on.
15s	The backlight turns off 15 seconds after the last operation.
30s	The backlight turns off 30 seconds after the last operation.

Adjusting the display contrast

1. Press **SETTING**.

This opens the SETTING screen.



2. Press **5**.

This opens the PWR/LCD screen.

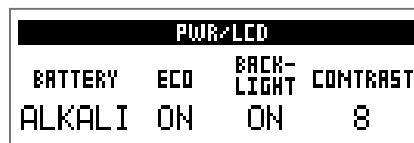

3. Turn **4**  **Vol.**

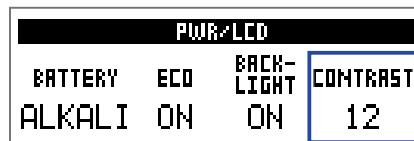



HINT

This can be set from 1 to 13.

Using the tuner

Use this to tune the connected instrument.

Activating the tuner

1. When using MEMORY, STOMP or EDIT mode, press  and  at the same time. This activates the tuner.



HINT

Pressing anything other than  will close the tuner and return to the original screen.

Tuning instruments

1. Play the sound that you want to tune and adjust its pitch. The display will differ according to the selected tuner type. (→ [“Changing tuner settings” on page 43](#))

■ CHROMATIC tuner

Use this to tune to the nearest note (in semitones).

The nearest note name and pitch detuning will be shown on the display and by the LEDs.

When the pitch is accurate, the LED at the center of the meter will light green and the LEDs to the left and right will light red.

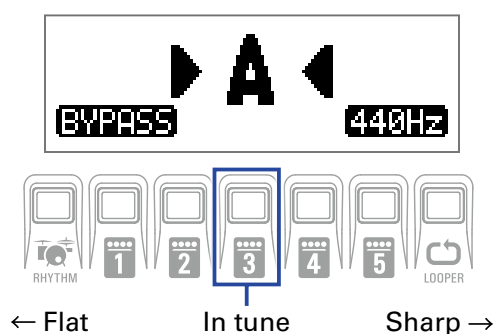

■ Other tuners (for guitars)

Use this to tune to the correct pitch for the nearest string number, which is shown according to the selected type.

The nearest string number and pitch detuning will be shown on the display and by the LEDs.

When the pitch is accurate, the LED at the center of the meter will light green and the LEDs to the left and right will light red.

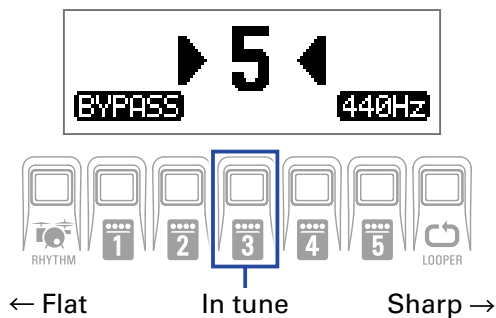

Changing tuner settings

1. Press  when the Tuner Screen is open.

This opens the TUNER settings screen.

TUNER			
OUTPUT	CALIB	TYPE	FLAT
BYPASS	440	CHROMATIC	---

■ Setting the output method

1. Turn .

TUNER			
OUTPUT	CALIB	TYPE	FLAT
MUTE	440	CHROMATIC	---

Setting	Explanation
BYPASS	Effects are bypassed and the instrument sound is output.
MUTE	The instrument sound is not output.

HINT

You can also turn  on the Tuner Screen to change this setting.

■ Adjusting the standard pitch

1. Turn .

TUNER			
OUTPUT	CALIB	TYPE	FLAT
BYPASS	442	CHROMATIC	---

HINT

- This sets middle A between 435 and 445 Hz.

- You can also turn  on the Tuner Screen to change this setting.

■ Setting the tuner type

1. Turn .

TUNER			
OUTPUT	CALIB	TYPE	FLAT
BYPASS	440	GUITAR	b×0

Setting	Explanation
CHROMATIC	The pitch detuning is shown according to the nearest note (in semitones).
Other tuner types	The nearest string number is shown according to the selected type, and the amount of detuning from its pitch is shown. The following tuner types can be selected.

Display	Explanation	String number/note						
		7	6	5	4	3	2	1
GUITAR	Standard guitar tuning with a 7th string	B	E	A	D	G	B	E
OPEN A	Open A tuning (open strings play A chord)	–	E	A	E	A	C#	E
OPEN D	Open D tuning (open strings play D chord)	–	D	A	D	F#	A	D
OPEN E	Open E tuning (open strings play E chord)	–	E	B	E	G#	B	E
OPEN G	Open G tuning (open strings play G chord)	–	D	G	D	G	B	D
DADGAD	Alternate tuning often used for tapping and other techniques	–	D	A	D	G	A	D

■ Using flat tunings (for guitars)

1. Turn .

All strings can be tuned flat from an ordinary tuning by one (b×1), 2 (b×2) or 3 (b×3) semitones.

TUNER			
OUTPUT	CALIB	TYPE	FLAT
BYPASS	440	GUITAR	b×3

NOTE

Flat tuning cannot be used when the tuner type is “CHROMATIC”.

Preventing feedback

Select Anti FB (anti feedback) as an effect to use the anti-feedback function. This function can detect and cut the frequency band that is feeding back to reduce it.

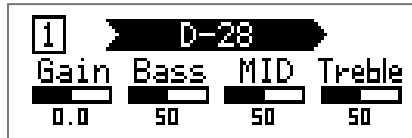

1. Select a patch memory for assignment of the Anti FB effect in MEMORY mode.

2. Press  repeatedly to activate EDIT mode.



3. Press  - .

Assign Anti FB to the beginning of the effect chain to maximize its effectiveness.

4. While pressing , press  and select **FILTER**.

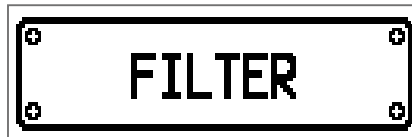

5. Press  or , and select **Anti FB**.



6. Turn  to select the setting.

Select **Auto** to automatically find and cut the frequency band that is causing feedback.

The frequency band can also be selected manually.

7. Press  -  to turn **Anti FB** on.

• **If Auto was selected in step 6:**

Detection of the feedback frequency band will begin, and "Scanning" will appear on the display.

When the frequency band has been found, the message will disappear and the anti-feedback function will become active.

• **If a frequency band was selected in step 6:**

The anti-feedback function will become active and the selected frequency band will be cut.

HINT

- If a patch memory that includes the Anti FB effect is saved the detected feedback frequency band will also be saved.
 - In STOMP mode, Anti FB can be turned on using a footswitch.
 - Multiple Anti FB effects can be used.
-

Using rhythms



You can play along with built-in rhythms.

Activating the rhythm function

1. When using MEMORY, STOMP or EDIT mode, press  RHYTHM.
This opens the RHYTHM screen.

RHYTHM	0000
PATTERN Count.	BPM VOL
Metro	ON 120 80

HINT

- Press  to return to the original mode.
 - During rhythm playback, press  to continue rhythm playback and return to the original mode.
 - The looper can be used during rhythm playback. When the RHYTHM screen is open, press  to switch to the LOOPER screen. (→ [“Using the looper” on page 50](#))
-

Setting the rhythm

■ Selecting rhythm patterns

1. Turn .

This selects the rhythm pattern. (→ [“Rhythm patterns” on page 49](#))

RHYTHM	Oooo		
PATTERN	Count	BPM	VOL
Cajon2	ON	120	80

■ Setting the precount

1. Turn .

This sets the precount.

This plays a count sound before looper recording starts.

RHYTHM	Oooo		
PATTERN	Count	BPM	VOL
Cajon2	OFF	120	80

Setting	Explanation
OFF	A precount is not played.
ON	A precount is played.

■ Adjusting the tempo

1. Turn .

RHYTHM	Oooo		
PATTERN	Count	BPM	VOL
Cajon2	OFF	124	80

HINT

- This can be set from 40 to 250.
- The tempo set here will be shared by the effects and the looper.

■ Adjusting the volume

1. Turn .

RHYTHM	Oooo		
PATTERN	Count	BPM	VOL
Cajon2	OFF	124	84

HINT

This can be set from 0 to 100.

Starting/stopping rhythm playback

1. Press .

This starts rhythm playback.

RHYTHM	●	000
PATTERN	Count	BPM VOL
Cajon2	OFF	124 84

2. Press .

This stops rhythm playback.

HINT

During rhythm playback, you can switch MEMORY, STOMP and EDIT modes. To stop rhythm playback,

press  to open the RHYTHM screen, and then press .

Rhythm patterns

No.	Pattern Name	Time Sig.
1	Metro	
2	Metro3	3/4
3	Metro4	4/4
4	Metro5	5/4
5	Guide1	4/4
6	Guide2	4/4
7	Cajon1	4/4
8	Cajon2	4/4
9	Cajon3	4/4
10	Cajon4	4/4
11	Country1	2/4
12	Country2	2/4
13	Blues1	4/4
14	Blues2	4/4
15	Shuffle1	4/4
16	Shuffle2	4/4
17	Shuffle3	4/4
18	Shuffle4	4/4
19	Bossa1	4/4
20	Bossa2	4/4
21	Jazz1	4/4
22	Jazz2	4/4
23	Jazz3	4/4

No.	Pattern Name	Time Sig.
24	Jazz4	4/4
25	8Beats1	4/4
26	8Beats2	4/4
27	8Beats3	4/4
28	8Beats4	4/4
29	16Beats1	4/4
30	16Beats2	4/4
31	Funk1	4/4
32	Funk2	4/4
33	Fusion	4/4
34	JzFunk1	4/4
35	JzFunk2	4/4
36	Pop80s1	4/4
37	Pop80s2	4/4
38	Motown	4/4
39	Disco	4/4
40	Samba1	4/4
41	Samba2	4/4
42	Samba3	4/4
43	Salsa1	4/4
44	Salsa2	4/4
45	CubaGrv1	4/4
46	CubaGrv2	4/4

No.	Pattern Name	Time Sig.
47	Djembe1	4/4
48	Djembe2	4/4
49	Reggae1	4/4
50	Reggae2	4/4
51	NuSoul1	4/4
52	NuSoul2	4/4
53	LoFiHH1	4/4
54	LoFiHH2	4/4
55	NuJazz1	4/4
56	NuJazz2	4/4
57	House1	4/4
58	House2	4/4
59	Techno1	4/4
60	Techno2	4/4
61	DanceHall	4/4
62	Triplet	4/4
63	JzWaltz1	3/4
64	JzWaltz2	3/4
65	CtWaltz1	3/4
66	CtWaltz2	3/4
67	5/4Grv1	5/4
68	5/4Grv2	5/4

Using the looper

You can record your playing and create mono loop phrases that are up to 30 seconds long.

Activating the looper

1. When using MEMORY, STOMP or EDIT mode, press  LOOPER.
This opens the LOOPER screen.



HINT

Press  LOOPER to return to the original mode.

Setting the looper

■ Setting of the loop recording time

1. Turn .

LOOPER	
Time	StopMode POSI VOL
♪x2	Instant Post 80

Setting	Explanation
MANUAL	Recording will continue until stopped manually or the maximum recording time is reached.
♪x1-64	Set the value to 1 – 64 quarter notes. The actual recording time depends on the BPM setting. Recording time (seconds) = 60 ÷ BPM × quarter notes

NOTE

- The looper recording time is between 1.5 and 30 seconds.
- Settings that will not fit in the recording time will be adjusted automatically.
- Changing the recording time will delete the recorded data.

■ Setting how looping stops

1. Turn .

LOOPER	
Time	StopMode POSI VOL
♪x2	Finish Post 80

Setting	Explanation
Instant	Stops immediately after the stop operation.
Finish	The loop will stop after playing to its end.
Fade Out	The loop will stop after fading out.

■ Setting the looper position

1. Turn  ³

LOOPER			
Time	StopMode	POSI	VOL
↓x2	Finish	Pre	80

Setting	Explanation
Pre	The looper is positioned before the effects.
Post	The looper is positioned after the effects.

HINT

This is convenient when using acoustic instruments that are loud unamplified because putting the looper at the beginning of the effect chain allows sound to be played once, then looped and manipulated without additional playing.

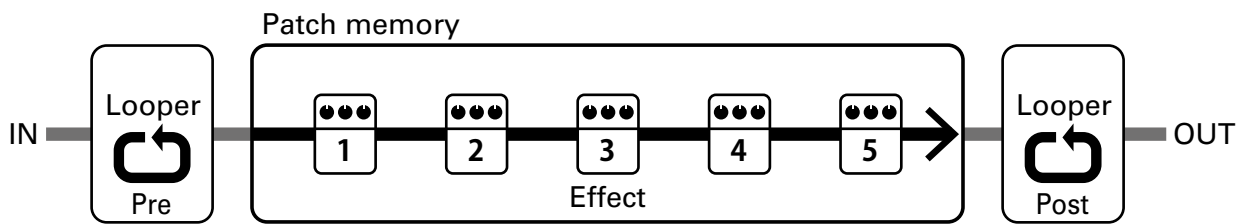

■ Adjusting the volume

1. Turn  ⁴

LOOPER			
Time	StopMode	POSI	VOL
↓x2	Finish	Pre	86

HINT

This can be set from 0 to 100.

Looper tempo

The tempo used for the looper is shared by the effects and the rhythm.

The tempo can be set on the SETTING screen (→ [“Adjusting the master tempo” on page 29](#)) or the RHYTHM setting screen (→ [“Setting the rhythm” on page 47](#)).

Changing the tempo will delete the recorded data.

Recording and playing loops

1. Press .

This starts loop recording.



2. Stop recording and start loop playback.

If the recording time is set to "Manual"

Pressing  again or allowing the maximum recording time to be reached will stop recording and start loop playback.

If the recording time is set to "J x1-64"

When the set recording time is reached, recording will stop and loop playback will start.



3. Press .

This stops loop playback.



NOTE

- During rhythm playback, recording will start after the precount.
- Sound input through the AUX IN jack will not be recorded.

HINT

- During rhythm playback, quantization is enabled so even if the recording ending time is not exact, the loop will automatically be adjusted so that loop playback stays in time.
- During loop playback, you can switch MEMORY, STOMP and EDIT modes.

Overdubbing loops

Additional performances can be added to the recorded loop.

1. Press  during loop playback.

This starts overdubbing.

When the end of the loop is reached, loop playback will continue from the beginning, and overdubbing can be repeated.



2. Press  during overdubbing.

This stops overdubbing, but continues loop playback.

Clearing the loop

1. When loop playback is stopped, press and hold .
This clears the recorded loop.



Using the expression pedal (A1X_{FOUR} only)

If an effect in the PEDAL category is selected when using an A1X_{FOUR}, you can control the amount of the effect with the expression pedal.

Setting pedal effects

1. In EDIT mode, select an effect from the PEDAL category.

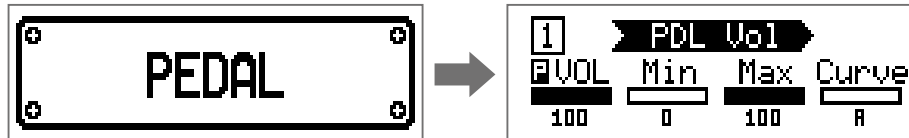

NOTE

Only one effect in a patch memory can be selected from the PEDAL category.

HINT

Selecting effects from categories (→ [“Selecting effect categories”](#) on page 22)

2. Turn $1 \text{ } \textcircled{O}_{\text{Lo}}$ – $4 \text{ } \textcircled{O}_{\text{Vol}}$.

This adjusts the pedal effect. (→ [“Adjusting effect parameters”](#) on page 23)

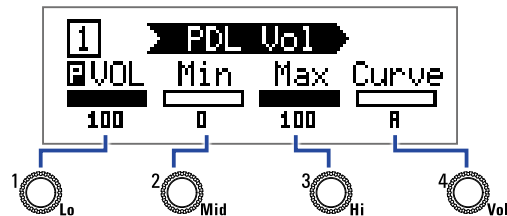

3. Use the expression pedal.

This changes the amount of the effect.

HINT

Press the front-end of the expression pedal down to turn the pedal effect ON/OFF. This does not, however, save the ON/OFF setting.

Adjusting the pedal

Adjusting the pedal sensitivity

1. While pressing  ^{SETTING}, turn the **A1X_{FOUR}** power on.
This opens the PEDAL CALIBRATION screen.



2. Operate the pedal as shown on the display, and press  or  each time.

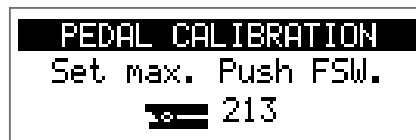

Calibration is finished when "Complete!" appears.

NOTE

- Adjust the pedal sensitivity in the following cases.
 - Stepping on the pedal has little effect.
 - The volume and tone changes greatly even when the pedal is only pressed lightly.
- If "Error!" appears, start calibration again from the beginning.

Adjusting the torque

1. Insert a 5 mm hex wrench into the torque adjustment screw on the side of the pedal.
2. Turn it clockwise to tighten the pedal and counterclockwise to loosen it.

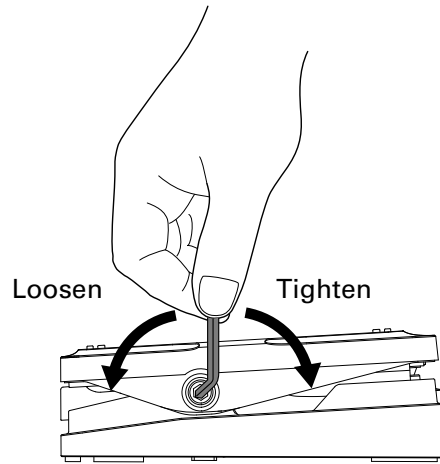

NOTE

Be careful because loosening the torque adjustment screw too much could cause it to become disconnected internally, making it impossible to keep the pedal in a fixed position.

Managing the firmware

Checking the firmware versions

1. While pressing , turn the **A1 FOUR/A1X FOUR** power on.

This opens the firmware version screen.



VERSION		
SYSTEM	PRESET	BOOT
1.01	1.00	1.00
FSW: START		

2. Press  or .

This restarts the **A1 FOUR/A1X FOUR** and reopens the usual screen.

Updating the firmware

Check the ZOOM website (www.zoom.co.jp/), and download firmware for the **A1_{FOUR}/A1X_{FOUR}**.

1. While pressing both  and , use a USB cable to connect the **A1_{FOUR}/A1X_{FOUR}** and the computer.

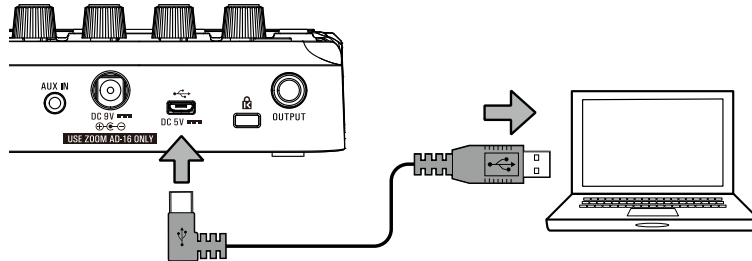

This turns the **A1_{FOUR}/A1X_{FOUR}** power on and opens the FIRMWARE UPDATE screen.

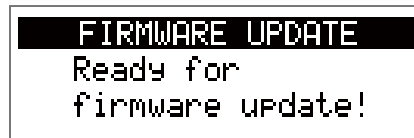

2. Launch the firmware update application on the computer.

This will start the update.

"Complete!" will appear when updating finishes.



NOTE

- Do not disconnect the USB cable during a firmware update.
- In the unlikely event that a firmware update should fail while in progress, conduct the procedures from the beginning to update the firmware again.

HINT

See the ZOOM website for details about using the application.

3. After updating completes, disconnect the USB cable and turn the power off.

HINT

Updating the firmware will not erase saved patch memories.

Restoring factory default settings

1. While pressing , turn the A1 FOUR/A1X FOUR power on.

This opens an initialization confirmation screen.

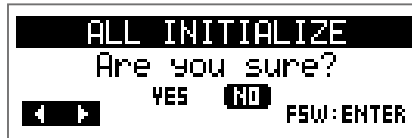

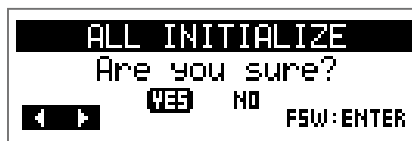

2. Turn .

This selects the operation.



Setting	Explanation
YES	Initialize settings, rewriting them with the factory defaults.
NO	Cancel initialization and return to the usual screen.

3. Press  or .

This starts initialization.

When initialization finishes, "Complete!" appears, and then the usual screen reopens.



NOTE

Initialization will overwrite all settings, including patch memories, to their factory defaults. Be certain before using this function.

Troubleshooting

The unit will not power on

- If using batteries, connect a cable to the INPUT jack.

Sound output is silent, very quiet or distorted

- Check the connections. (→ [“Connecting” on page 10](#))
- Adjust the levels of the effects. (→ [“Adjusting effect parameters” on page 23](#))
- Adjust the patch memory level. (→ [“Changing patch memory levels” on page 16](#))
- Adjust the output volume. (→ [“Adjusting the overall audio character and output level” on page 13](#))
- If you are using the expression pedal to adjust the volume, adjust the pedal position until the volume level is suitable.
- Confirm that the tuner output is not set to “MUTE”. (→ [“Changing tuner settings” on page 43](#))
- Adjust the level of the connected instrument.
- Adjust the MAA-1 input level. (→ [“Adjusting the MAA-1 input level” on page 12](#))

There is a lot of noise

- Confirm that a shielded cable is not the cause.
- Use a genuine ZOOM AC adapter. (→ [“Connecting” on page 10](#))

Effects are not working

- If the effect processing power is being exceeded, “PROCESS OVERFLOW” will appear on the display. When “PROCESS OVERFLOW” appears for an effect, it will be bypassed. (→ [“Changing effect types” on page 22](#))

Batteries lose their charge quickly

- Confirm that you are not using manganese batteries. Alkaline batteries should provide about 18 hours of continuous operation.
- Confirm the battery setting.
The setting must match the batteries being used in order to show the remaining battery charge accurately. (→ [“Setting the type of batteries used” on page 37](#))
- Due to their characteristics, batteries discharge more quickly when used in cold places.

Expression pedal does not work well (A1X_{FOUR} only)

- Check the expression pedal settings. (→ [“Using the expression pedal” on page 56](#))
- Adjust the expression pedal. (→ [“Adjusting the pedal” on page 57](#))

Specifications

■ A1_{FOUR}/A1X_{FOUR}

Maximum number of simultaneous effects	5	
Number of patch memories	50	
Sampling frequency	44.1 kHz	
A/D conversion	24-bit 128x oversampling	
D/A conversion	24-bit 128x oversampling	
Signal processing	32-bit	
Display	128x32 dot-matrix LCD	
Inputs	INPUT	Standard mono phone jack Rated input level: -20 dBu Input impedance (line): 470 kΩ
	AUX IN	Stereo mini jack Rated input level: -10 dBu Input impedance (line): 1 kΩ
Output	OUTPUT	Standard stereo phone jack (combined line/headphone) Maximum output level: Line at +2 dBu (10 kΩ or more output impedance) Headphones at 17 mW + 17 mW (32Ω load)
Input S/N	120 dB	
Noise floor (residual noise)	-97 dBu	
Power	AC adapter: 9V DC 500mA center negative (ZOOM AD-16) 4 AA batteries (about 18 hours continuous operation time when using alkaline batteries with the LCD backlight off)	
USB	USB MIDI, USB Micro-B • Power can also be supplied through the USB port. • When using a cable designed only for power, other USB functions cannot be used.	
External dimensions	A1 _{FOUR} 156 mm (D) × 130 mm (W) × 42 mm (H) A1X _{FOUR} 156 mm (D) × 216 mm (W) × 52 mm (H)	
Weight	A1 _{FOUR} 340 g (excluding batteries) A1X _{FOUR} 610 g (excluding batteries)	

■ MAA-1

Input	XLR balanced input (2: hot) Input gain: +3 – +30 dBu Input impedance: 10 kΩ Maximum input level: +4 dBu +48V phantom power
Output	Standard mono phone jack Nominal output level: -20 dBu Maximum output level: +7 dBu Output impedance: 1 kΩ
Power	2 AA batteries Continuous operation time (when phantom current is 3 mA) About 15 hours (using alkaline batteries) About 15 hours (using nickel metal hydride batteries)
External dimensions	177 mm (D) × 23 mm (W) × 25 mm (H)
Weight	70 g (excluding batteries)

• 0 dBu = 0.775 V

• Continuous battery operation times were determined using in-house testing methods. They will vary greatly according to use conditions.



4-4-3 Kanda-surugadai, Chiyoda-ku, Tokyo 101-0062 Japan
www.zoom.co.jp