

V6

Vocal Processor

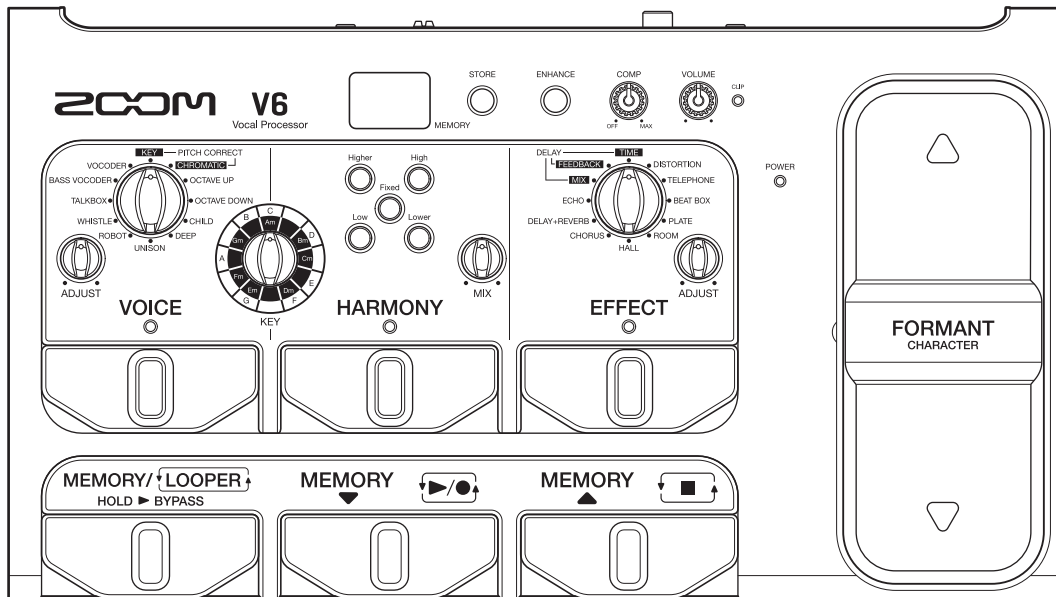

Operation Manual

You must read the Usage and Safety Precautions before use.

© 2020 ZOOM CORPORATION

Copying or reprinting this manual in part or in whole without permission is prohibited.

Product names, registered trademarks and company names in this document are the property of their respective companies. All trademarks and registered trademarks in this document are for identification purposes only and are not intended to infringe on the copyrights of their respective owners.

Proper display is not possible on grayscale devices.

■ Operation Manual overview

You might need this manual in the future. Always keep it in a place where you can access it easily. The contents of this document and the specifications of the product could be changed without notice.

- Windows® is a trademark or registered trademark of Microsoft® Corporation.
- Mac and macOS are trademarks or registered trademarks of Apple Inc.
- iOS is a trademark or registered trademark of Cisco Systems, Inc. and used under license.
- Other product names, registered trademarks and company names in this document are the property of their respective companies.

Note: All trademarks and registered trademarks in this document are for identification purposes only and are not intended to infringe on the copyrights of their respective owners.

Introduction

Thank you very much for purchasing a ZOOM **V6** Vocal Processor.

The **V6** has numerous functions for transforming vocals and is easy-to-use, so anyone can achieve powerful vocal sounds. After adjusting volume and clarity, you can, for example, correct the pitch of vocals while adding harmony and reverb.

Setting values and combinations can be saved as patch memories in the unit to be used whenever you like. You can try out a variety of vocal effects right away by switching among the preset patch memories.

With other features that include a unique formant pedal that can be used to change vocal characteristics, a looper that can record overdubs for up to 3.5 minutes and a super-directional ZOOM SGV-6 mic, this vocal processor is perfect for live performances.

We hope you will enjoy using it for many years.

Main features of the **V6**

Easy sound creation

Creating sounds is as easy as turning knobs and pressing switches.

Super-directional ZOOM SGV-6 mic

The super-directional ZOOM SGV-6 mic, which is based on shotgun mic technologies, catches the sound of the vocalist with focused directionality. Using the SGV-6 suppresses feedback and interference from nearby instruments when capturing a voice, enabling more accurate pitch correction and harmonization.

Voice character manipulation pedal

The FORMANT pedal can be used to change vocal characteristics without changing pitch, making it sound like the voice of a different person.

The vocal automatically returns to its original character when the foot is removed from the pedal.

Singing assistance

Using the compressor to even out volume and the enhance function to add clarity helps make singing easier.

Voice, harmony and effect sections

The VOICE section allows you to easily pitch-correct vocals or create a robotic sound, for example.

The HARMONY section can be used to automatically generate third-degree and fifth-degree harmonies according to the KEY setting.

The EFFECT section is optimized for vocalists. The 10 types of effects include echo and reverb as well as aggressive distortion.

3.5-minute looper great for improvisations

The looper can be used to overdub processed vocals as many times as desired, greatly expanding performance possibilities.

Convenient undo and redo functions can be easily performed with a footswitch.

USB audio interface

The **V6** can be used as a 2-IN/2-OUT audio interface.

Terms used in this manual

Patch memory

Records of voice, harmony and effect settings are called “patch memories” and can be used to easily recall settings. Up to 100 patch memories can be stored.

Looper

Vocal loops can be recorded for up to 3.5 minutes and played back.

Loops can be layered for a variety of live performance techniques, including a cappella choruses and vocal percussion.

Memory mode

Use this mode to select patch memories with the footswitches.

Looper mode

Use this mode to operate the looper with the footswitches.

VOICE

This section can alter the sound of the voice. For example, use it to correct pitch according to the key or give the voice a childlike, synthesized or vocoder sound.

HARMONY

This can add up to two harmonizing voices. This generates optimal harmonies automatically according to the key.

EFFECT

This section adds reverb, distortion or another effect to the original sound to change its tone.

FORMANT

Formants are vocal characteristics created by differences in mouth and throat shapes.

The FORMANT pedal of the **V6** can be used to change vocal characteristics without changing the pitch.

COMP (compressor)

Input sounds over a certain level can be compressed to lower their volume and even out the overall volume.

ENHANCE

This can make singing clearer by emphasizing high frequencies, and it can make the voice sound pleasanter by suppressing sibilant sounds as in “hiss” and “shhh”.

ECO mode

This function will automatically turn the power off 10 hours after the last operation.

Contents

Introduction	3	Bypassing the effect of the V6	28
Terms used in this manual	4	Making other settings	29
Contents	5	Setting the standard pitch for voices and harmonies	29
V6 structure	6	Setting the type of batteries used	30
Names and functions of parts	7	Setting ECO mode to turn the power off automatically when not used	31
Making connections	10	Restoring factory default settings	32
ZOOM SGV-6 mic overview	11	Using audio interface functions	33
Turning the power on	12	Installing the driver	33
Using batteries	13	Connecting to a computer	34
Adjusting the volume and tone	14	Updating the firmware	35
Adjusting the mic input volume	14	Troubleshooting	36
Reducing volume variation (compressor function)	14	Specifications	38
Bringing out vocal character (enhance function)	15		
Adjusting headphone volume.....	15		
Selecting patch memories	16		
Using the VOICE section	17		
Using the HARMONY section	19		
Using the EFFECT section	21		
Saving settings in patch memories	23		
Using the FORMANT pedal	24		
Adjusting the stiffness of the FORMANT pedal.....	24		
Using the looper	25		
Activating the looper	25		
Recording and playing loops	25		
Overdubbing loops	26		
Clearing the loop	27		
Display indicators	27		

V6 structure

■ Signal flow

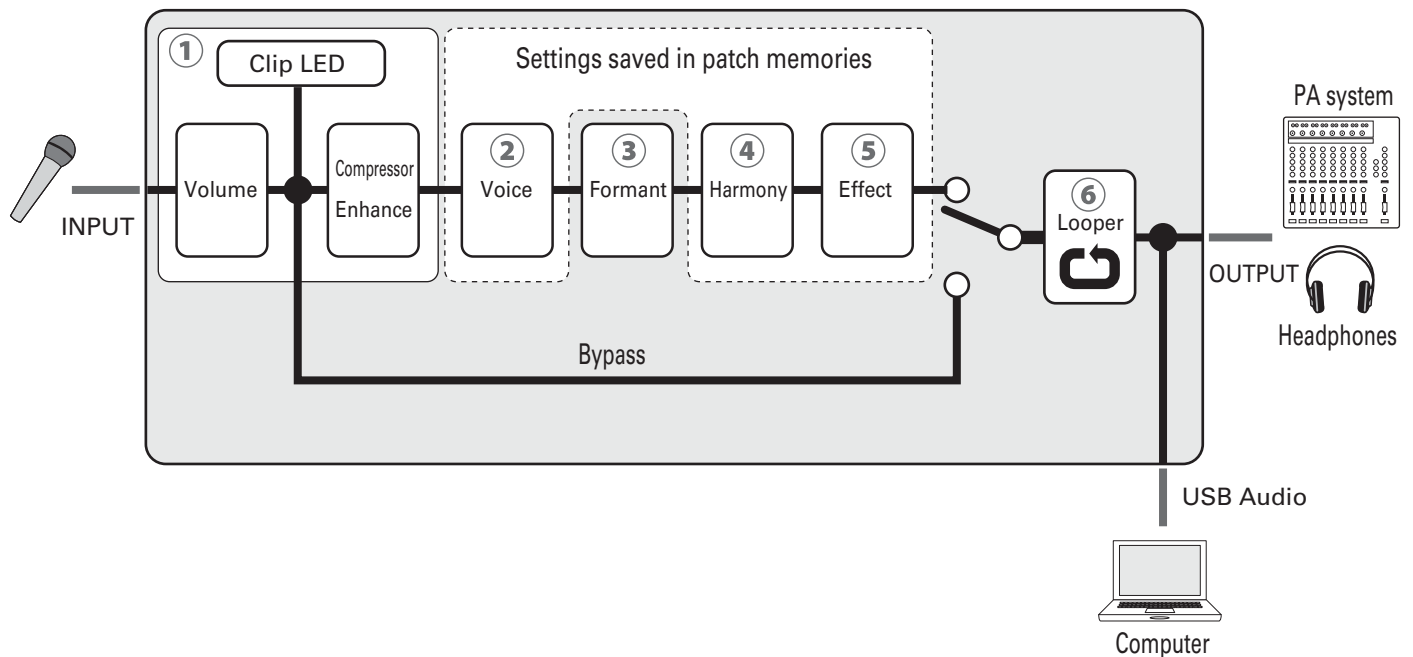

- ① The volume and tone of the input from the mic can be adjusted.
(→ [“Adjusting the volume and tone” on page 14](#))
- ② This can alter vocals with pitch correction, pitch shifting, vocoder and other options.
(→ [“Using the VOICE section” on page 17](#))
- ③ The FORMANT pedal can be used to change vocal characteristics without changing the pitch.
(→ [“Using the FORMANT pedal” on page 24](#))
- ④ This can add up to two harmonizing voices.
(→ [“Using the HARMONY section” on page 19](#))
- ⑤ Use this to apply delay, reverb or another effect.
(→ [“Using the EFFECT section” on page 21](#))
- ⑥ Recorded loops can be played back repeatedly.
(→ [“Using the looper” on page 25](#))

HINT

VOICE, HARMONY and EFFECT settings (②, ④ and ⑤) can be saved in patch memories and easily recalled. (→ [“Selecting patch memories” on page 16](#), [“Saving settings in patch memories” on page 23](#))

Names and functions of parts

■ Front panel

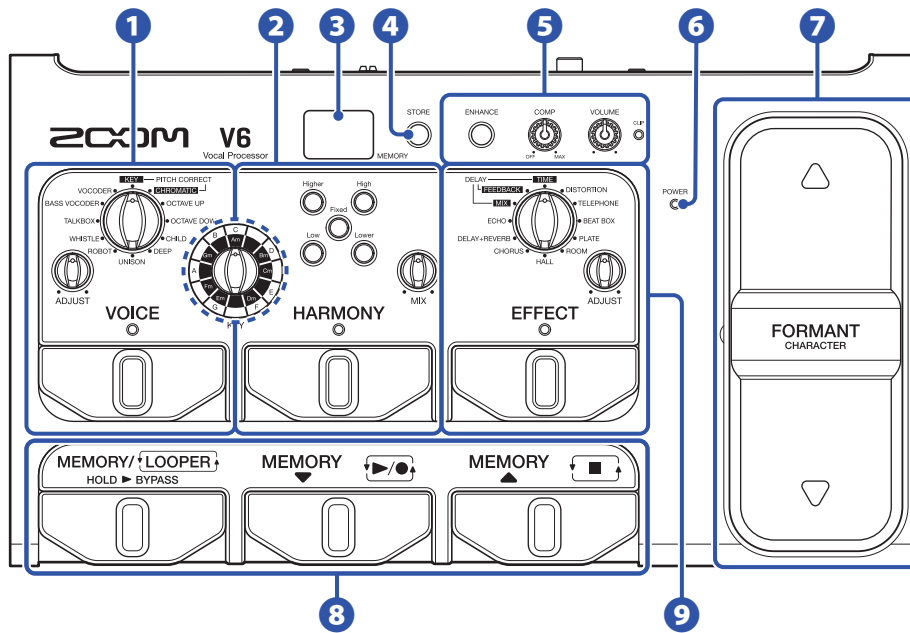

1 VOICE section

Alter vocals with pitch correction, pitch shifting, vocoder and other options.

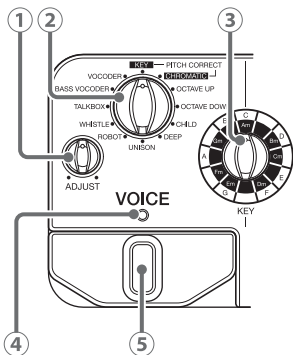

- ① **VOICE ADJUST knob**
Use to adjust the voice.
- ② **VOICE selection knob**
Select the voice type.
- ③ **KEY selection knob**
Select the key for pitch correction.
- ④ **VOICE indicator**
This shows whether the VOICE section is on or off.
- ⑤ **VOICE footswitch**
Turn the VOICE section on/off.

2 HARMONY section

Add up to two harmonizing voices.

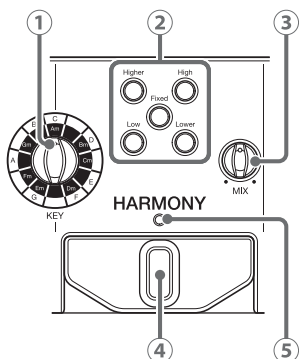

- ① **KEY selection knob**
Select the key for harmonization.
- ② **HARMONY style buttons**
Press to activate harmony types.
- ③ **HARMONY MIX knob**
Adjust the balance between the vocal and the harmony.
- ④ **HARMONY footswitch**
Turn the HARMONY section on/off.
- ⑤ **HARMONY indicator**
This shows whether the HARMONY section is on or off.

3 Display

This shows the selected patch memory number and looper status.

4 STORE button

Press to save the current settings to a patch memory.

5 Input control section

Adjust the volume and tone of the input from the mic.

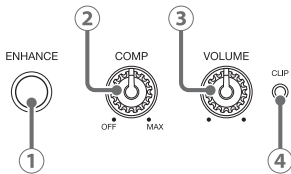

1 ENHANCE button

Turn the ENHANCE function on/off.

2 COMP knob

Adjust the amount of compression.

3 VOLUME knob

Adjust the mic input volume.

4 CLIP indicator

This shows the status of the input sound.

6 POWER indicator

This shows whether the power is on or off and the remaining battery charge.

7 FORMANT pedal

Change the character of the voice.

8 Patch memory/looper control section

Select patch memories and operate the looper.

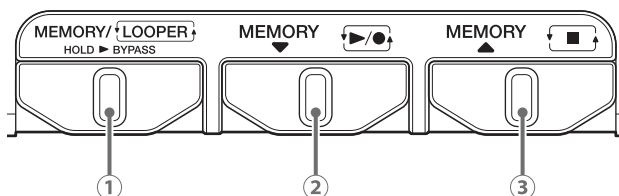

1 MEMORY/LOOPER footswitch

Switch between memory and looper modes. Press and hold to bypass the effect of the **V6**.

2 MEMORY ▼ footswitch

Use to select patch memories. When in looper mode, use to record and play loops.

3 MEMORY ▲ footswitch

Use to select patch memories. When in looper mode, use to stop loops.

9 EFFECT section

Apply delay, reverb or another effect.

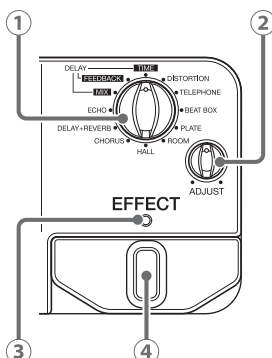

1 EFFECT selection knob

Select the effect.

2 EFFECT ADJUST knob

Adjust the effect.

3 EFFECT indicator

This shows whether the EFFECT section is on or off.

4 EFFECT footswitch

Turn the EFFECT section on/off.

■ Rear panel

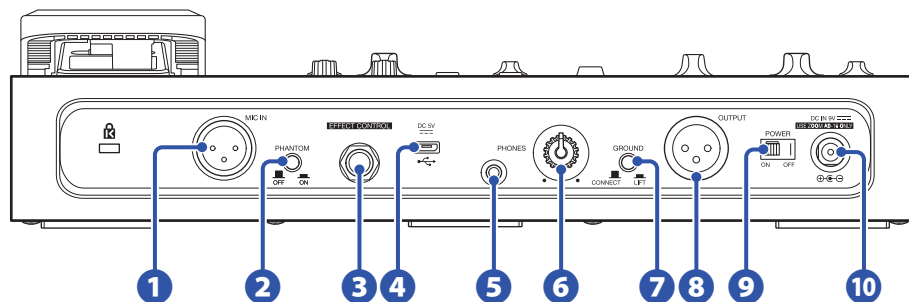

1 MIC IN jack

Connect a mic here.

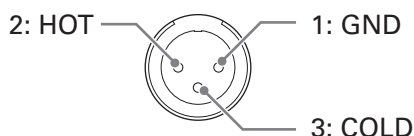

2 PHANTOM switch

Turn +48V phantom power ON/OFF.

Turn this ON when connecting a ZOOM SGV-6 mic or a condenser mic that requires phantom power, for example.

3 EFFECT CONTROL connector

An expression pedal (ZOOM FP02M) can be connected here to control the effect.

4 USB port

Connect a computer here to use the **V6** as an audio interface or to update the **V6** firmware. A mobile battery, for example, can also be connected here to provide power.

5 PHONES output jack

Connect headphones here.

6 PHONES output volume knob

Adjust the headphone output volume.

7 GROUND LIFT switch

This connects/disconnects the output jack ground.

8 OUTPUT jack

Connect this to a mixer, other PA system, recorder or other audio device that can adjust sound balance.

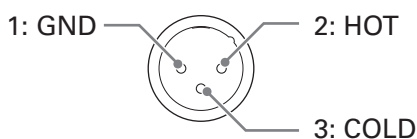

9 POWER switch

Turn the power on/off.

10 DC 9V AC adapter connector

Connect a dedicated AC adapter (ZOOM AD-16) here.

Making connections

Mic (ZOOM SGV-6 or commercially-available mic)

Use a mic cable to connect it to the MIC IN jack.

Connect a cable with an XLR connector (female) to the OUTPUT jack. Use a cable with a connector that suits the PA system or recorder input jack. The **V6** output is line level. Connect it to a line input jack on the other equipment.

Mixer, PA system, recorder, etc.

PHANTOM
OFF ON
When connecting a ZOOM SGV-6, condenser mic or other device that requires phantom power, set the PHANTOM switch to ON.

Stereo mini plug headphones

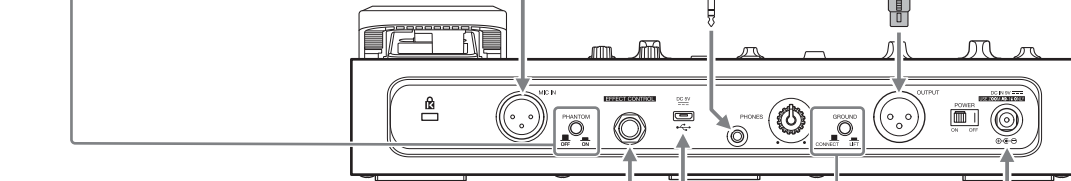

Expression pedal (ZOOM FP02M)

Connected to the EFFECT CONTROL jack, the pedal can be used to control the effect.

Use a Micro USB cable to connect to the USB port.

Computer

AC adapter (ZOOM AD-16)

GROUND
CONNECT LIFT

This connects/disconnects the output jack ground.

- **CONNECT:** The grounding pin is connected to the ground.
- **LIFT:** The grounding pin is disconnected from the ground. This is effective if noise is caused by a ground loop.

NOTE

Always set the PHANTOM switch to OFF when connecting a device that does not support phantom power. The device could be damaged if this is not done.

ZOOM SGV-6 mic overview

The SGV-6 is a mic with focused directionality based on the technologies of shotgun mics, which are designed to capture sound in the direction they are pointed.

By capturing only the vocal, sounds from other instruments on stage are suppressed, enabling accurate pitch correction and harmonization.

■ Using the SGV-6

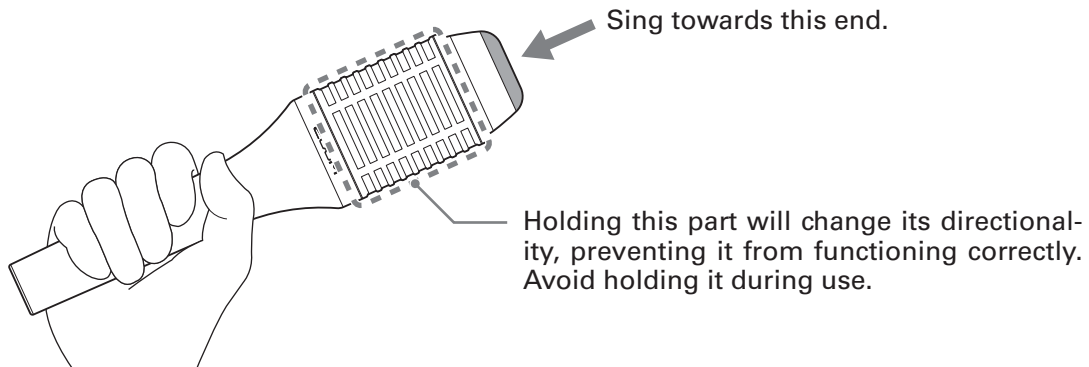



NOTE

The SGV-6 is a delicate device. Do not drop it or hit it with excessive force.

Turning the power on

1. Minimize the volume of output devices.

2. Set  to ON.

This turns the **V6** on, and  lights green.

3. Raise the volume of output devices.

HINT

- 4 AA batteries can also be used. Use only one type of battery (alkaline, NiMH or lithium) at a time. (→ [“Using batteries” on page 13](#))
 - Power for operation can also be supplied through the USB port.
-

ECO mode overview

- By default, ECO mode is set to ON, so the power will automatically turn off if no use occurs for 10 hours.
- ECO mode can also be set to OFF on the SETTING screen. (→ [“Setting ECO mode to turn the power off automatically when not used” on page 31](#))

Using batteries

Open the battery compartment cover on the bottom of the product and insert 4 AA batteries.

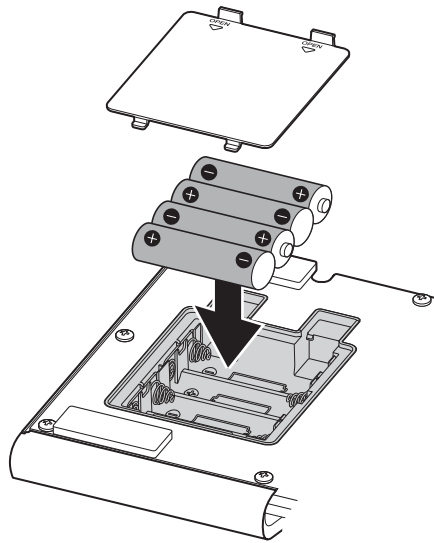

NOTE

- Set the type of battery used correctly so that the amount of remaining battery charge can be shown accurately. (→ [“Setting the type of batteries used” on page 30](#))
- POWER
● lights red when the remaining battery power becomes low. Replace the batteries with new ones.

Adjusting the volume and tone

Adjusting the mic input volume



1. Turn .

While singing, adjust it so  lights green.

Quieter  Louder

NOTE

Adjust the mic input volume to a level that enables the VOICE and HARMONY sections to function properly.

-  Volume too high
-  Volume suitable
-  Volume too low

Reducing volume variation (compressor function)

Input sounds over a certain level can be compressed to lower their volume and even out the overall volume.

If a single song contains both shouting or other loud singing and quiet whisper-like singing, for example, matching the level to the loud singing will cause the quiet singing to become inaudible. Compressing the volume of loud singing to reduce overall volume differences makes quiet singing easier to hear.

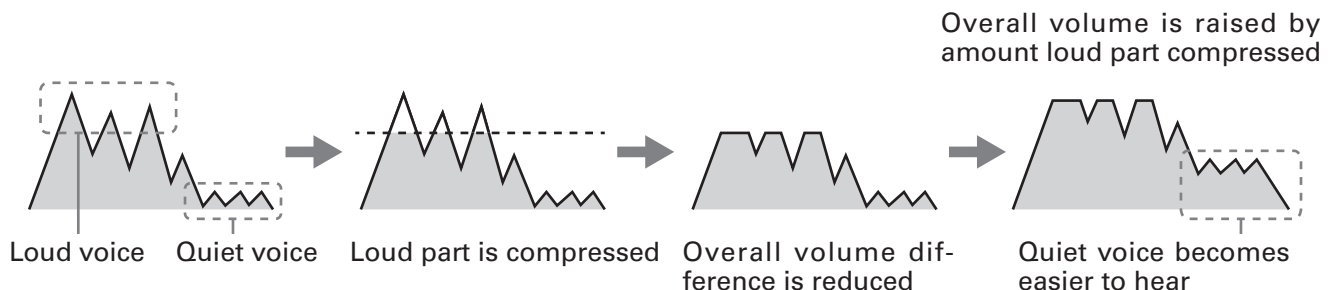

1. Turn .

Turn it right to increase the effect.

Turn it completely left to turn the compressor function off.

Bringing out vocal character (enhance function)

The **V6** enhance function has two effects.

- **Bringing out vocal character**

By emphasizing high frequencies, this can make singing clearer, so that it is not lost in the sound of a band.

- **Suppressing "s" sounds and other sibilant sounds**

Sibilant sounds are produced by air pushed through gaps between teeth and include hissing "s" sounds. Suppressing sibilant sounds that become distracting when the mic volume is turned up can make voices sound pleasanter.

1. Press  .

This turns the enhance function on and  lights.

Adjusting headphone volume

When using headphones to listen to the **V6**, turn the PHONES knob to adjust the volume.

1. Turn  .

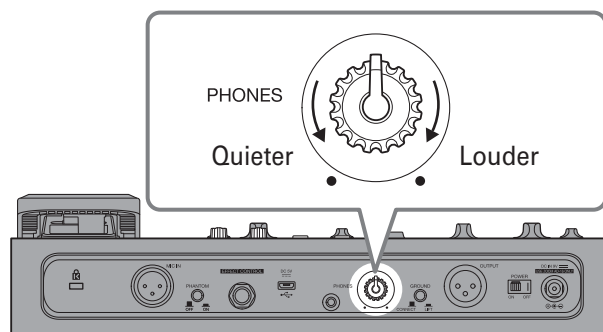

Selecting patch memories

The **V6** comes with patch memories that allow a variety of vocal sounds to be tried right away. Patch memories store all VOICE, HARMONY and EFFECT section settings. Up to 100 patch memories can be stored.

1. Press  or .

Use these to select patch memories.

The selected patch memory number is shown on the display.

HINT

- When the **V6** power is turned on, the settings of the patch memory last used will be loaded and the display will show the patch memory number.
 - If VOICE, HARMONY or EFFECT settings are adjusted,  will light, showing that they are different from the saved settings. Save the settings as needed. (→ [“Saving settings in patch memories” on page 23](#))
-

V6 mode overview

The **V6** has two modes: memory and looper.

- In memory mode, patch memories can be selected.
- In looper mode, the looper can be used.

Press  to switch between the modes.

Memory mode is active when the **V6** power is turned on.

Using the VOICE section

Use this section to alter the sound of the voice. For example, use it to correct pitch according to the key or give the voice a childlike, synthesized or vocoder sound.

1. Press .

The VOICE section is activated, and  lights.

2. Turn .

This selects the voice.

3. Turn .

This adjusts the voice.

Voice	Explanation	ADJUST function
PITCH CORRECT - KEY**	This corrects the pitch to the set key.* This can be adjusted from a gentle pitch correction to a mechanical effect that changes the pitch in steps.	Pitch correction amount
PITCH CORRECT - CHROMATIC**	This corrects the pitch to semitones. This can be adjusted from a gentle pitch correction to a mechanical effect that changes the pitch in steps. We recommend this setting when a song is in an unknown key or it has numerous key changes.	Pitch correction amount
OCTAVE UP	This doubles the voice one octave up. Together with the HARMONY function, rich harmonies with three voices can be generated.	Balances original and effect sounds
OCTAVE DOWN	This doubles the voice one octave down. Together with the HARMONY function, rich harmonies with three voices can be generated.	Balances original and effect sounds
CHILD**	This makes the voice high-pitched and childlike by raising the pitch and changing the character greatly. This also corrects pitch to the set key.*	Pitch correction amount
DEEP**	This makes the voice low-pitched and deep by lowering the pitch and changing the character greatly. This also corrects pitch to the set key.*	Pitch correction amount
UNISON	This creates an effect like singing the same part twice by duplicating the sound with the pitch and timing slightly shifted.	Effect mix level

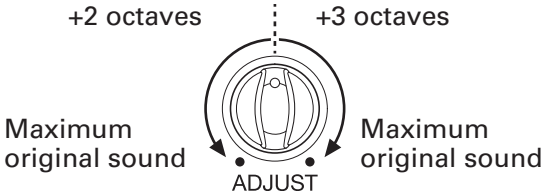
ROBOT**	<p>This transforms the sound into a robotic voice output at the root note of the set key.* Using this during intros and interludes can enhance the performance of a song.</p>	Robot voice octave
WHISTLE	<p>This has the effect of sounding like whistling even when just singing. The octave of the whistling is different according to whether the setting of the ADJUST knob is on the left or right half. Choose the octave according to the pitch of the singing and adjust the loudness of the original sound.</p> <div style="text-align: center;">  </div>	Amount of original sound in mix/whistle octave
TALKBOX**	<p>This creates a talk box sound effect. This corrects the pitch to the set key.* TALKBOX pitch correction follows a blue note scale and adds a $\flat 3$ to major scales and a $\flat 5$ to natural minor scales.</p>	Pitch correction amount
BASS VOCODER**	<p>This creates a vocoder sound effect lowered one octave. This corrects the pitch to the set key.* Increasing the pitch correction brings the sound closer to the pitch of the same note played on a keyboard.</p>	Pitch correction amount
VOCODER**	<p>This creates a vocoder sound effect. This corrects the pitch to the set key.* Increasing the pitch correction brings the sound closer to the pitch of the same note played on a keyboard. Use this together with the HARMONY function for even greater effect.</p>	Pitch correction amount

*For details about setting the key, see step 2 of [“Using the HARMONY section” on page 19](#).

**This follows the standard pitch setting (→ [“Setting the standard pitch for voices and harmonies” on page 29](#)).

Using the HARMONY section

In the HARMONY section, two of the five options can be selected to generate harmonies automatically based on the KEY setting.

1. Press .

The HARMONY section is activated, and  lights.

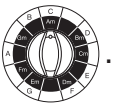
2. Turn .

Set the key of the song being sung.

When using sheet music, the key can be determined from the key signature.

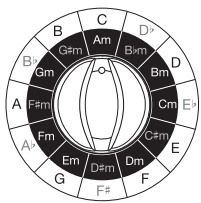

Major key



Minor key

Major key



Minor key

What is a key?

A key is a musical scale of 7 notes used in a song. Bright-sounding scales are known as major keys and dark-sounding scales are known as minor keys. The first note in the scale gives the key its name (A–G). For example, the bright-sounding scale that begins with C (Do) and has the seven notes C, D, E, F, G, A and B (Do, Re, Mi, Fa, Sol, La and Ti) is called the C major key. Likewise, the dark-sounding scale that contains the same notes, but begins with A (La) is the A minor (Am) key.

C Major

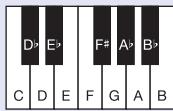

Do, Re, Mi, Fa, Sol, La, Ti



C/Do, D/Re, E/Mi, F/Fa, G/Sol, A/La, B/Ti



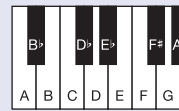

A Minor

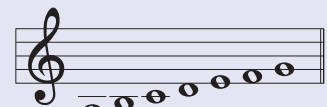

La, Ti, Do, Re, Mi, Fa, Sol



A/La, B/Ti, C/Do, D/Re, E/Mi, F/Fa, G/Sol

3. Press , , ,  or .

 lights, and the selected harmony is added. Press repeatedly to cycle through volume levels: high → medium → low → off. The brightness changes with the level.

Up to two harmony options can be activated. Activating a third harmony option will cancel the first one that was activated.

Harmony	Explanation
Higher	+5 or +6 degrees
High	+3 or +4 degrees
Fixed	The note of the key selected in step 2 (fixed)
Low	-3 or -4 degrees
Lower	-5 or -6 degrees

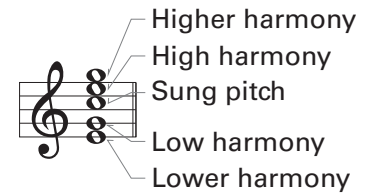

Each harmony is generated automatically according to the key selected in step 2.

Example 1: Singing a C note when the key is C major with High and Higher selected will produce the following notes.

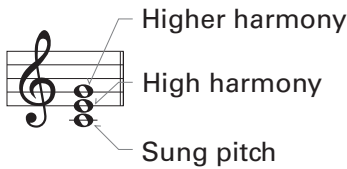

Example 2: Singing C, D, E, F, G, A and B (Do, Re, Mi, Fa, Sol, La and Ti) when the key is C major will produce the following notes.

- Higher: G, A, C, C, D, E, F (Sol, La, Do, Do, Re, Mi, Fa)
- High: E, F, G, A, C, C, D (Mi, Fa, Sol, La, Do, Do, Re)
- Sung pitch: C, D, E, F, G, A, B (Do, Re, Mi, Fa, Sol, La, Ti)
- Low: G, A, C, C, D, E, F (Sol, La, Do, Do, Re, Mi, Fa)
- Lower: E, F, G, A, C, C, D (Mi, Fa, Sol, La, Do, Do, Re)

Pitches added with the HARMONY function

“Degrees” are the number of steps in the scale from the fundamental pitch of the key.

-8 -7 -6 -5 -4 -3 -2 +2 +3 +4 +5 +6 +7 +8

Do Re Mi Fa Sol La Ti Do Re Mi Fa Sol La Ti Do

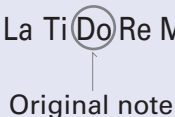

For example, when “Higher” is activated, Harmony will automatically be generated +5 or +6 degrees above the sung pitch.

4. Turn 

This adjusts the balance of the original with the harmony sounds.

Only the harmony sound will be output when turned all the way to the right.

Using the EFFECT section

This section adds reverb, distortion or another effect to the original sound to change its tone.

1. Press .

The EFFECT section is activated, and  lights.

2. Turn .

This selects the effect.

3. Turn .

This adjusts the effect.

Effect	Explanation	ADJUST function
DISTORTION	Distorts the voice heavily	Distortion amount
TELEPHONE	Retro-sounding telephone emulation	Frequency band affected
BEAT BOX	Adds impact for beat boxing. This adds power to kick and snare sounds while emphasizing the sharpness of high hats. A moderate amount of compression also evens out the volumes of kick, snare and high hat sounds, which tend to vary greatly.	Boost amount
PLATE*	Plate reverb simulation	Reverb duration and mix amount
ROOM*	Tight reverb that simulates room acoustics	Reverb duration and mix amount
HALL*	Dense reverb that simulates hall acoustics	Reverb duration and mix amount
CHORUS	Thick, gentle chorus	Effect mix level
DELAY+REVERB*	Combines delay and reverb	Reverb duration and mix amount
ECHO	Crisp short delay that brings out clarity	Effect mix level
DELAY**	Clear-sounding delay that allows detailed parameter settings	TIME
		FEEDBACK
		MIX

*This produces a stereo effect. (Stereo output is possible from the PHONES OUT jack.)

**The DELAY effect is set by its TIME, FEEDBACK and MIX settings.

Notes about effects

TELEPHONE: This cuts high and low frequencies and distorts the sound to give it a lo-fi quality.

REVERB: Adding reverberations gives the sound width and depth.

CHORUS: Adding just a small amount of fluctuation gives the sound thickness and textural variation.

DELAY: By repeating the sound at regular intervals, an effect that follows the rhythm can be created.



Adjusting the delay

DELAYTIME: This adjusts the amount of time before the delay sound. This can be set to up to 2 seconds.

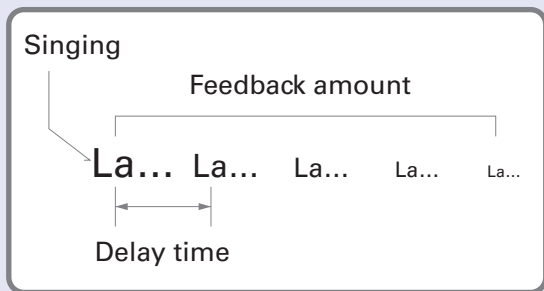
FEEDBACK amount: This adjusts the number of times the delay sound is repeated.



HINT

- When DELAY - TIME is selected,  functions as a tap tempo setting switch for the delay time. Press  repeatedly to set the delay time to the interval between presses.
- If an expression pedal (ZOOM FP02M) is connected, it can be used to adjust the effect (same as turning ). Adjustments made with a pedal are not saved in the patch memory.

Saving settings in patch memories

VOICE, HARMONY, and EFFECT settings can be saved as patch memories.

1. Press .

The display blinks.

2. Press  or .

Select the destination patch memory.

The selected patch memory number is shown on the display.

3. Press .

The current settings are saved.

HINT

Press  to cancel saving.

Using the FORMANT pedal

Formants are vocal characteristics created by differences in mouth and throat shapes.

By using the FORMANT pedal to change the formant, vocal characteristics can be changed without changing the pitch.

1. Operate the FORMANT pedal.

This changes the character of the voice.

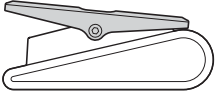

Press forward (toe)

This makes the voice higher and cuter.

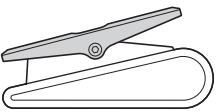

Press backward (heel)

This makes the voice lower and heavier.

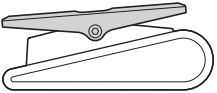

Unpressed state

The vocal automatically returns to its regular character when the foot is removed.

Adjusting the stiffness of the FORMANT pedal

The FORMANT pedal torque can be adjusted so that it responds as you like to pressing.

1. Insert a 5mm hex wrench into the torque adjustment screw on the side of the pedal.

2. Turn it clockwise to tighten the pedal and counterclockwise to loosen it.

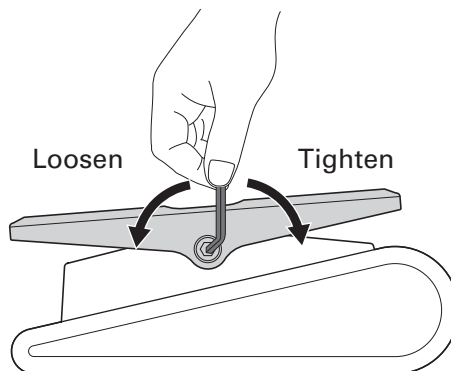

NOTE



Be careful because loosening the torque adjustment screw too much could cause it to become disconnected internally, making it impossible to keep the pedal in a fixed position.

Using the looper

Vocals can be recorded and loops created for up to 3.5 minutes.

Loops can be layered for a variety of live performance techniques, including a cappella choruses and vocal percussion.

Activating the looper

1. When in memory mode, press .  appears on the display.

HINT 

Press  to return to memory mode.

Recording and playing loops

1. Press .

The recording starts, and  appears on the display.

HINT

Press  to cancel recording ( will appear on the display).

2. Press  again.

Recording stops, playback starts, and  appears on the display.

If the maximum recording time is reached, recording will stop automatically and loop playback will start.

3. Press .

Playback stops and  blinks on the display.

Overdubbing loops

Additional performances can be added to the recorded loop.

1. Press  during loop playback.

Overdubbing starts, and  appears on the display.

When the end of the loop is reached, loop playback will continue from the beginning, and overdubbing can be repeated.



2. Press  during overdubbing.

This stops overdubbing, but continues loop playback.

 appears on the display.



■ Removing the last recorded loop

1. During loop playback, press  twice quickly.

After  blinks on the display,  appears.

■ Restoring the removed loop

1. After removing a loop, press  twice quickly again.





After  blinks on the display,  appears.

Clearing the loop

1. When loop playback is stopped, press and hold .

The recorded loop is cleared, and  appears on the display.

Display indicators

Indicator	Explanation
	LOOPER: No loop recorded
	REC: Loop being recorded
	PLAY: Loop being played back (blinks when stopped)
	UNDO: Last overdubbed loop being removed
	REDO: Loop removed using UNDO being restored

Bypassing the effect of the V6

1. Press and hold  .

The effect of the **V6** is bypassed, and the display appears as follows.

In memory mode

 The patch memory number and "bP" appear alternately.

In looper mode



 The looper status and "bP" appear alternately.

Press  to stop bypassing.

Making other settings

Setting the standard pitch for voices and harmonies



This adjusts the standard pitch used for correcting vocal pitch and adding harmony.

1. While pressing and holding , set  to ON.

After  appears on the display, the current setting value appears.

2. Press  or .

Set the standard pitch in 1Hz intervals (the default is 440 Hz).

 435 Hz
⏏
 445 Hz

What is the standard pitch?

The pitch used for "A" (La) is expressed in hertz (Hz).

Vocal and harmony pitches can be matched to the instruments being played together by setting the standard pitch used by the **V6** to the same pitch.

3. Press .



The display blinks rapidly, the setting is saved, and the **V6** starts normal operation.

HINT

Press  to cancel the setting change.

Setting the type of batteries used



Set the type of battery used correctly so that the amount of remaining battery charge can be shown accurately.

1. While pressing and holding , set  to ON.

After  appears on the display, the current setting value appears.

2. Press  or .

Set the type of batteries used.

-  Alkaline batteries
-  Nickel-metal hydride batteries
-  Lithium batteries

3. Press .



The display blinks rapidly, the setting is saved, and the **V6** starts normal operation.

HINT

Press  to cancel the setting change.

Setting ECO mode to turn the power off automatically when not used



This function can be used to turn the power off automatically if unused for 10 hours.

1. While pressing and holding , set  to ON.

After  appears on the display, the current setting value appears.

2. Press  or .

Select the setting.

-  The power will automatically turn off if unused for 10 hours.
-  ECO mode is off.



3. Press .

The display blinks rapidly, the setting is saved, and the **V6** starts normal operation.

HINT

Press  to cancel the setting change.

Restoring factory default settings

1. While pressing and holding , set  to ON.

 blinks on the display.

2. Press .

The display blinks rapidly, initialization occurs, restoring settings to their factory defaults, and the **V6** starts normal operation.

NOTE

Initialization will overwrite all settings, including patch memories, to their factory defaults. Be certain before using this function.

HINT

Press  to cancel the setting change.

Using audio interface functions

Installing the driver

■ Windows

1. Download the “ZOOM V6 Driver” from www.zoom.co.jp to the computer.

NOTE

- You can download the latest “ZOOM V6 Driver” from the above website.
- Download the driver for the operating system that you are using.

2. Launch the installer and follow the instructions to install the ZOOM V6 Driver.

NOTE

- See the Installation Guide included in the driver package for detailed installation procedures.
- If the power supplied by the USB bus is low, or you want to operate the unit with an adapter, use the dedicated AC adapter (ZOOM AD-16).

■ Mac and iOS devices

A driver is not necessary when using a Mac or iOS device.

Connecting to a computer

1. Use a USB cable to connect the **V6** with the computer or iOS device.

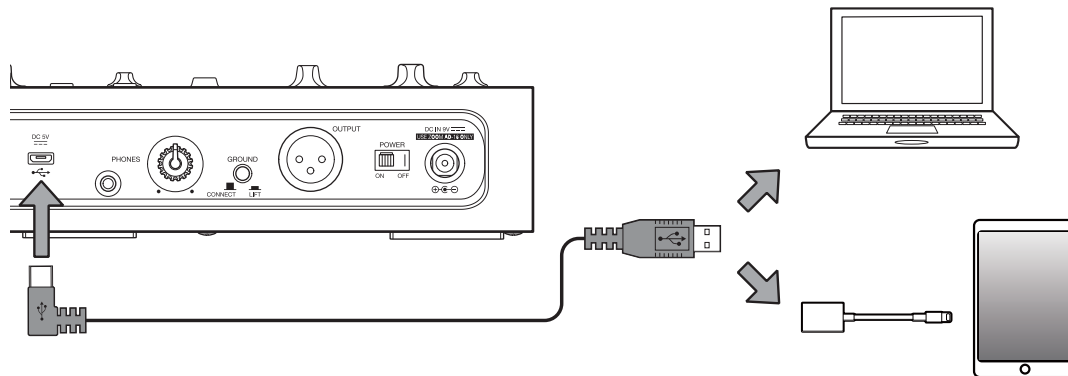

NOTE

When connecting to an iOS device, use a Lightning to USB camera adapter (or Lightning to USB 3 camera adapter).

2. Set  to ON.

After the **V6** turns on, it will connect to an iOS device.

When connecting to a computer, continue to step 3.

3. Set the **V6** as the sound device for use with the computer.

Updating the firmware

Check the ZOOM website (www.zoom.co.jp), and download firmware for the **V6**.

1. Use a USB cable to connect the **V6** and the computer.

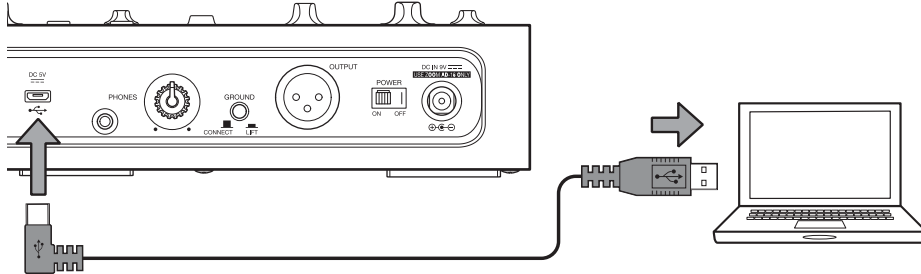

2. While pressing both  and , set  to ON.

This turns the **V6** on, and  lights orange.

 appears on the display.



3. Launch the firmware update application on the computer.

4. Execute the update.

While updating,  blinks orange.

When updating completes,  lights green.

NOTE

- Do not disconnect the USB cable during a firmware update.
- In the unlikely event that a firmware update fails while in progress,  will light red and  will appear on the display. Conduct the firmware update again from the first step in these procedures.

5. After updating completes, set  to OFF and disconnect the USB cable.

HINT

Updating the firmware will not erase saved patch memories.

Troubleshooting

The unit will not power on

- Confirm that the POWER switch is set to ON. (→ [“Turning the power on” on page 12](#))
- If using batteries, confirm that they are still charged. (→ [“Turning the power on” on page 12](#))

There is no sound or output is very quiet

- Check the connections. (→ [“Making connections” on page 10](#))
- Raise the volume of output devices.
- If using headphones, raise the headphone volume. (→ [“Adjusting headphone volume” on page 15](#))

There is a lot of noise

- Confirm that a shielded cable is not the cause.
- Use a genuine ZOOM AC adapter. (→ [“Making connections” on page 10](#))
- Check the GROUND LIFT switch setting. (→ [“Making connections” on page 10](#))

The sound distorts strangely or has an odd timbre

- Adjust the input volume to a suitable level. (→ [“Adjusting the mic input volume” on page 14](#))
- Adjust the amount of compression. (→ [“Reducing volume variation \(compressor function\)” on page 14](#))

The VOICE function has no effect

- Adjust the VOICE ADJUST knob. (→ [“Using the VOICE section” on page 17](#))

The HARMONY function has no effect

- Use the HARMONY MIX knob to adjust the harmony volume. (→ [“Using the HARMONY section” on page 19](#))
- Use the KEY selection knob to set the key correctly. (→ [“Using the HARMONY section” on page 19](#))

The EFFECT function has no effect

- Adjust the EFFECT ADJUST knob. (→ [“Using the EFFECT section” on page 21](#))

Batteries lose their charge quickly

- Confirm that you are not using manganese batteries. Alkaline batteries should provide about 3.5 hours of continuous operation.
- Confirm the battery setting.
The setting must match the batteries being used in order to show the remaining battery charge accurately. (→ [“Setting the type of batteries used” on page 30](#))
- Due to battery characteristics, they are discharged more quickly when used in places with low temperatures.

Specifications

VOICE section		12 types
EFFECT section		10 types
HARMONY section		5 types
Number of patch memories		100
Sampling frequency		44.1 kHz
A/D conversion		24-bit 128x oversampling
D/A conversion		24-bit 128x oversampling
Signal processing		32-bit
Frequency response		20 Hz–20 kHz (+1 dB/–3 dB) (200 kΩ load)
Display		2-digit 7-segment LED
Input	SGV-6	Directionality: Super cardioid (3 directional mic units) Sensitivity: –46 dB/Pa at 1 kHz (each mic unit) Maximum sound pressure input: 140 dBSPL
	MIC IN	XLR jack Input gain: +3 – +40 dB Maximum input level: +4 dBu Input impedance: 3 kΩ or higher (1 kHz) Phantom power: +48 V
Outputs	OUTPUT	XLR jack Maximum output level: +8 dBu Output impedance: 50 Ω (HOT-GND, COLD-GND, 1 kHz) 100 Ω (HOT-COLD, 1 kHz) GROUND LIFT (switchable)
	PHONES	Stereo mini jack Maximum output level: 20 mW + 20 mW (into 32 Ω load)
Equivalent input noise (when phantom power off)		–125 dBu or less (A-weighted, 150 Ω input, +40 dBu input gain)
Noise floor (residual noise)		–75 dBu
Control input		FP02 input
Power		AC adapter (9 V DC 500 mA, center negative) (ZOOM AD-16) 4 AA batteries (about 3.5 hours continuous operation time when using alkaline batteries)
USB		Connector: Micro USB Audio interface operation: 2-in/2-out USB2.0 Full Speed, 44.1 kHz, 16/24/32-bit • Power can also be supplied through the USB port. • When using a cable designed only for power, other USB functions cannot be used.
External dimensions		181 mm (D) × 320 mm (W) × 77 mm (H)
Weight		1.56 kg (excluding batteries)
Optional		FP02 expression pedal

Note: 0 dBu = 0.775 V



4-4-3 Kanda-surugadai, Chiyoda-ku, Tokyo 101-0062 Japan
www.zoom.co.jp