

M4

MicTrak

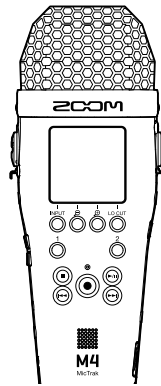

Quick Tour

An Operation Manual with more detailed explanations and other documents related to this product can be viewed on the following website.



www.zoom.jp/docs/m4

You must read the Usage and Safety Precautions before use.

Inserting microSD cards

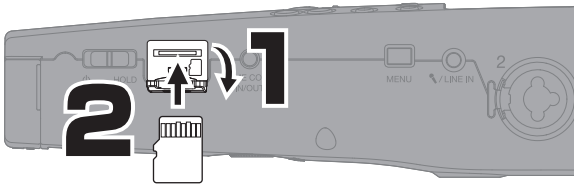

Supported recording media:
microSDHC: 4 GB – 32 GB
microSDXC: 64 GB – 1 TB

- Always turn the power off before inserting or removing a microSD card.
- To remove a microSD card, push it further into the slot and then pull it out.

Turning the power on

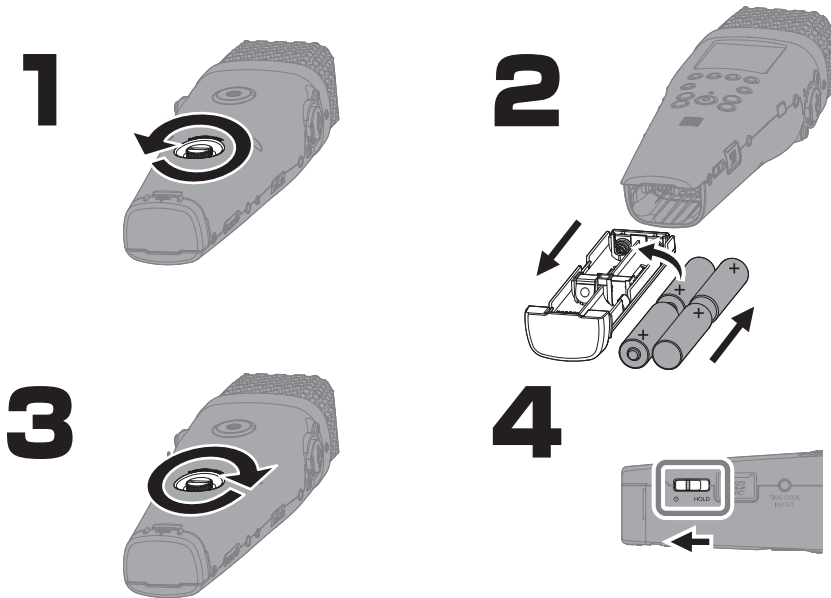

Use only one type of battery (alkaline, NiMH or lithium) at a time.

Power can also be supplied through the USB (Type-C) port by connecting a commercially-available mobile battery or a dedicated AC adapter (AD-17).

Making settings when first turned on

Setting the language

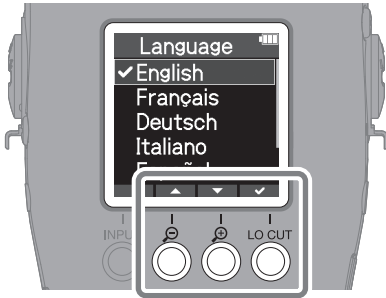

Use **←** / **→** to select the language and **✓** to confirm.

Setting the date format

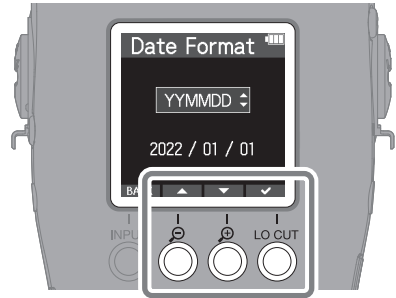

The year, month and day will be used in the recording file name in the order set here.

Setting the date and time

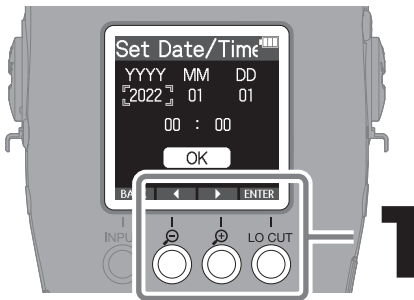

Select a setting item, and press **ENTER** to confirm.

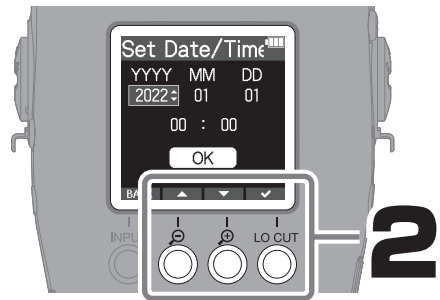

Change the value, and press **✓** to confirm.

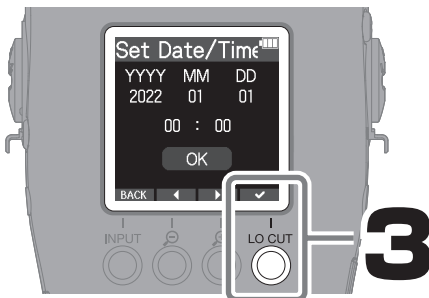

After setting all the items, select "OK" and press **✓** to complete setting the date and time.

If power is not supplied by an AC adapter or batteries for a long time, date and time settings will be reset. If the Set Date/Time Screen appears during startup, set them again.

Setting the battery type

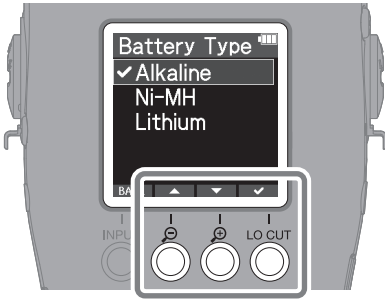

Set the type of battery used correctly so that the amount of remaining battery charge can be shown accurately.

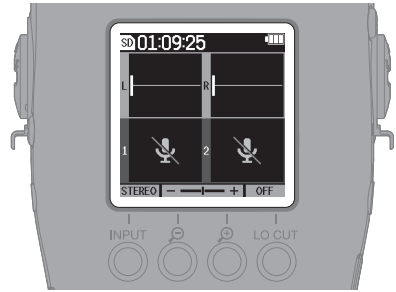

After setting is complete, the Home Screen will open.

Formatting microSD cards

Always format microSD cards in order to maximize their performance after purchasing them new or using them with a different device.

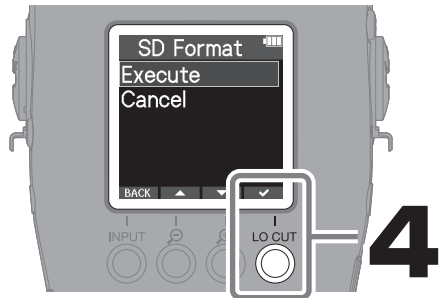
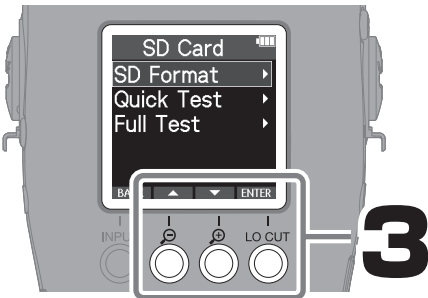
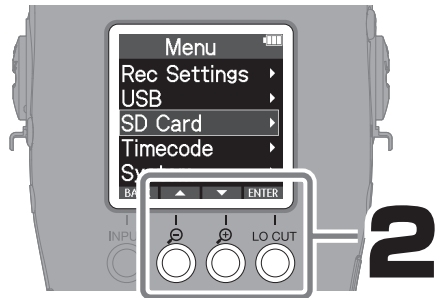
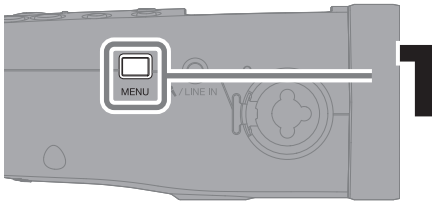

Press  to return to the Home Screen.

All data previously saved on a microSD card will be deleted when it is formatted.

The microSD card formatting screen can also be opened by pressing  while turning the power on.

Connecting input and output equipment

Recording live performances

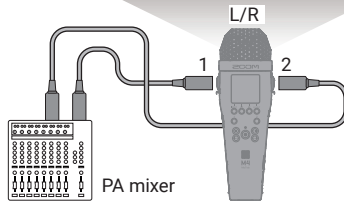



Recording performances with a voice and instrument

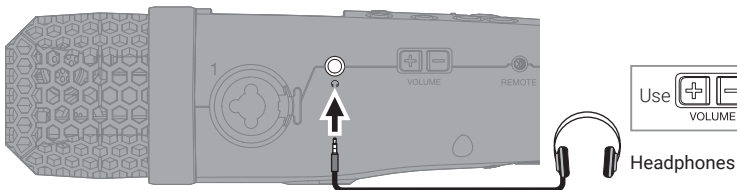

When disconnecting a mic, pull the XLR plug while pushing the connector lock release button.

Monitoring with headphones





Use  to adjust the volume.

Making input and recording settings

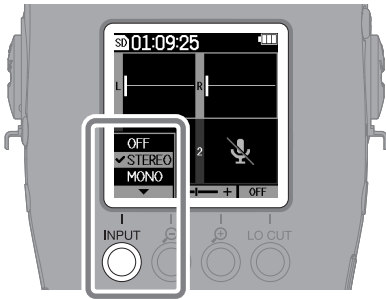
Built-in XY mic





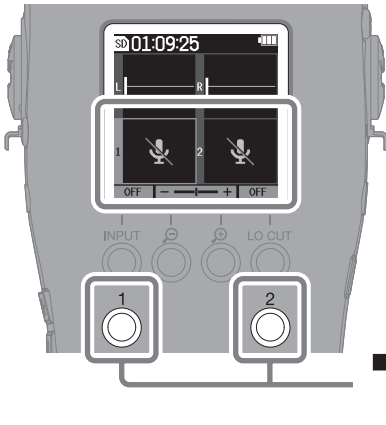

Selecting the recording format for the built-in XY mic

OFF	Sound from the built-in XY mic will not be recorded.
STEREO	This will record and save stereo files with the left and right signals from the built-in XY mic. 
MONO	This will record and save mono files that mix the left and right signals from the built-in XY mic. 

INPUT 1/2



Press  to set INPUT 1 and  to set INPUT 2.

Press  /  again to return to XY mic settings.

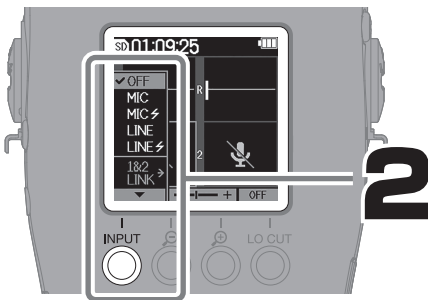

Selecting input sources for connected equipment

OFF	Use when nothing is connected (when not recording)
MIC	Use when connecting dynamic mics
MIC (⚡)	Use when connecting condenser mics
LINE	Use when connecting line level equipment
LINE (⚡)	Use when connecting line level equipment that requires phantom power
1&2 LINK	Use to stereo link INPUT 1 and 2

- Phantom power will be supplied if MIC (⚡) or LINE (⚡) is selected.
- Do not supply phantom power to devices that are not compatible with it. Doing so could damage the device.

■ Reducing noise from wind and vocal pops

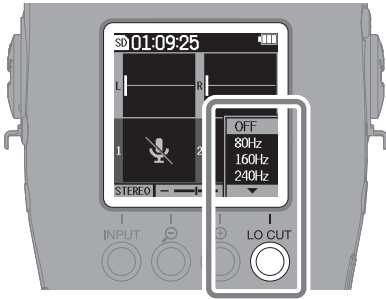

We recommend using a windscreen if air is blown directly at the mic, for example, when recording outdoors or when the mic is near the mouth of a speaker.

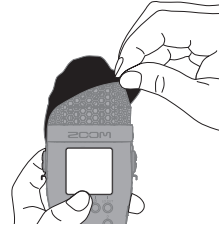

Adjusting volume amplification on the display

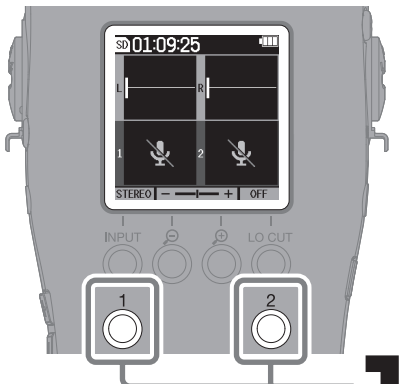

Select the desired input for volume amplification adjustment.

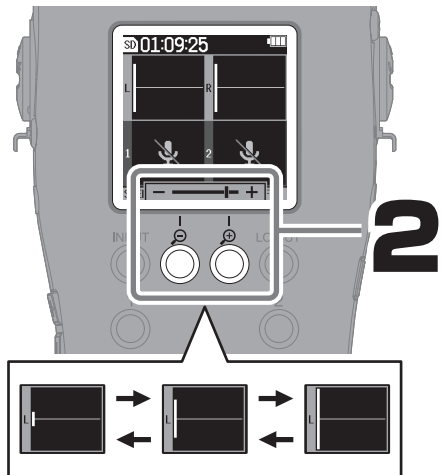

The M4 uses 32-bit float format, which can record with the same resolution for any volume level, so adjusting the recording level is unnecessary. During playback, the top and bottom edges of the waveform screen are the highest volume levels.

If the volume shown during recording is too small or too large, editing might be necessary for playback at a suitable volume. For this reason, we recommend using  to adjust the volume display to a suitable size when recording.

Recording

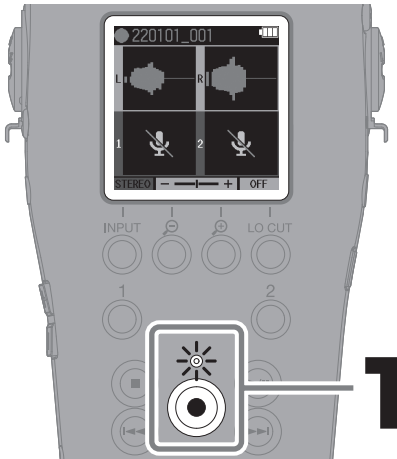

The indicator will light red and recording will start.

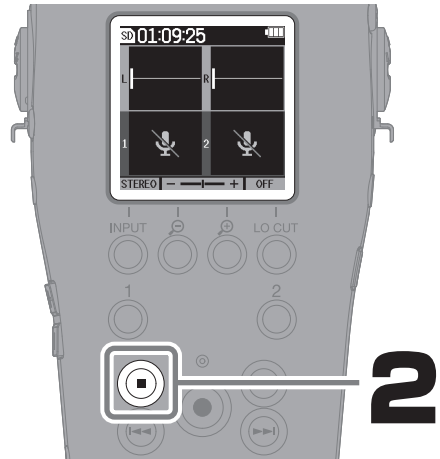

This ends recording.





Slide  toward HOLD when recording to prevent misoperation.

Playing recordings



This starts playback.

Operations during playback

LIST	This opens the FILE LIST Screen.
-3sec / +10sec	Use these to move the file playback position backward/forward.
OPTION	Use file functions, including deletion and export (bit depth conversion and normalization).
	This stops playback and re-opens the Home Screen.
	This starts and pauses playback.
	Use these to select the previous/next file. These will move between mark positions if there are marks. Press and hold to search backward/forward.
	This adds/deletes a mark at the current playback position.

■ Using the FILE LIST Screen

On the Playback Screen, press **LIST** to open the FILE LIST Screen.

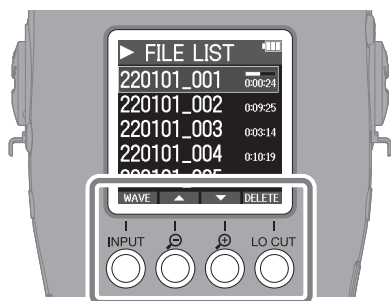

WAVE	This reopens the Playback Screen.
▲ / ▼	Use these to select files.
DELETE	This deletes the selected file.

Other functions

Sample Rate	The sampling rate used to record files can be set.
Pre-recording	Before recording is started, input signals can be captured for a certain amount of time.
Recording start tone	Tone signals can be output from the output jacks when recording is started. Tone signals are also written in recording files.
Automatic playback volume adjustment	The volumes of recorded sounds can be evened out without causing distortion during playback.
Recorded file export	Recorded files can be normalized, converted for devices that do not support 32-bit Float WAV format, and exported.
Line output level	The line output level can be adjusted.
USB Mic	The M4 can be used as a USB mic. Even during use as a USB mic, the M4 mic and INPUT 1/2 sounds can also be recorded to a microSD card.
USB file transfer	By connecting with a computer, data on the microSD card can be checked and copied.
Timecode	Timecode data can be written to recording files. Timecode signal (LTC) input and output is also supported.

Functions of parts

■ Front

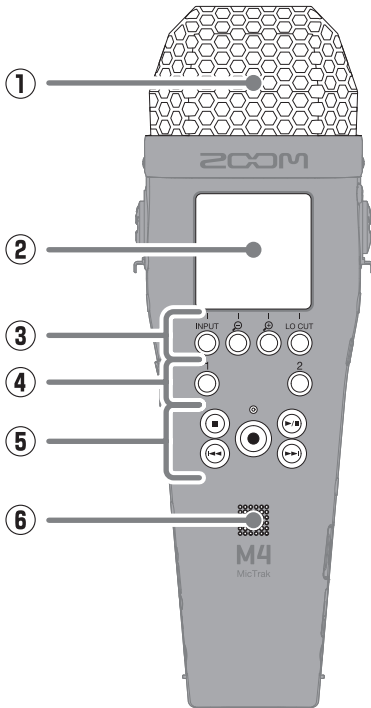

- 1 Built-in XY mic**
This stereo mic has two crossing directional mics. This mic can record three-dimensional sound with natural depth and width.
- 2 Display**
This shows various types of information.
- 3 Operation buttons**
When the Home Screen is open, these change settings related to sound being recorded. When the Home Screen is not open, these have functions shown by icons at the bottom of the screen.
- 4 Input 1 and 2 buttons**
Use these to select the XY mic, INPUT 1 or INPUT 2 for control on the Home Screen.
- 5 Recording/playback buttons**
These control recording and playback functions.
- 6 Speaker**
Sound is output here during file playback.

■ Back

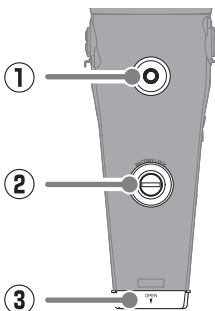

- 1 Tripod mounting threads**
Use these when connecting a tripod.
- 2 Battery compartment closure screw**
Use this when installing and removing the battery compartment.
- 3 Battery compartment**
Put batteries in here.

■ Left side

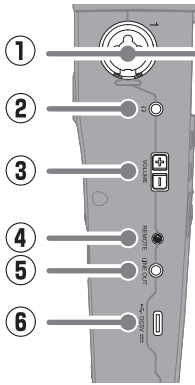

- ① **INPUT jacks**
Connect mics and mixers to these. These support XLR and 1/4-inch phone (TRS/TS) plugs.
- ② **Headphone jack**
This can output sound to headphones.
- ③ **VOLUME buttons**
Use these to adjust the volume output from the speaker and headphones.
- ④ **REMOTE connector**
Connected a dedicated remote control here.
- ⑤ **LINE OUT jack**
This outputs sound to a connected device.
- ⑥ **USB (Type-C) port**
Connect this to a computer, smartphone or tablet to use file transfer and USB mic functions.
This supports operation on USB bus power. Use a USB cable that supports data transfer.

■ Right side

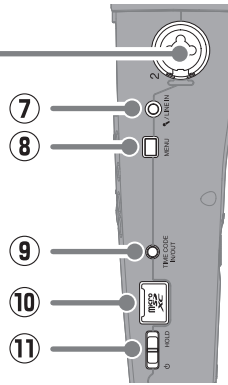

- ⑦ **MIC/LINE IN jack**
If an external mic is connected here, it can be used to record instead of the XY mic. This also supports mics that use plug-in power.
- ⑧ **MENU button**
Press this to open the Menu Screen.
- ⑨ **TIMECODE IN/OUT connector**
This inputs and outputs timecode signals.
- ⑩ **microSD card slot**
Insert a microSD card here.
- ⑪ **POWER/HOLD switch**
Use this to turn the power on/off and to disable button operation.

Troubleshooting

Sound is not output or the volume is very low

- Check the headphone connection.
- Confirm that the headphone volume is not lowered.
- Check the orientation of the mic or the volume settings of the connected equipment.
- Check the volume amplification on the display.
- Check the input source settings.
- Plug-in power must be supplied if the mic connected to the MIC/LINE IN jack supports plug-in power.

Monitored sound is distorted

- Adjust the volume amplification on the display.

Built-in mic sound is distorted

- Move the M4 away from the sound source. Use a windscreen if air is blown at the mic.

INPUT 1/2 sound is distorted

- Adjust the volume of connected devices, and confirm that input source settings are correct.

Recording is not possible

- Confirm that the microSD card has open space.
- Confirm that a microSD card is loaded properly in the card slot.

Recorded sound breaks up

- Use the M4 to format the microSD card.
- Test the microSD card.
See the Operation Manual for details.
- We recommend using microSD cards that have been confirmed to operate with this recorder.
See the ZOOM website (zoomcorp.com) for information about microSD cards that have been confirmed to work with this unit.

Not recognized by computer when connected

- Use a USB cable that supports data transfer.

Product names, registered trademarks and company names in this document are the property of their respective companies. All trademarks and registered trademarks in this document are for identification purposes only and are not intended to infringe on the copyrights of their respective owners.



ZOOM CORPORATION

4-4-3 Kanda-surugadai, Chiyoda-ku, Tokyo 101-0062 Japan

zoomcorp.com