

# G6

## Multi-Effects Processor

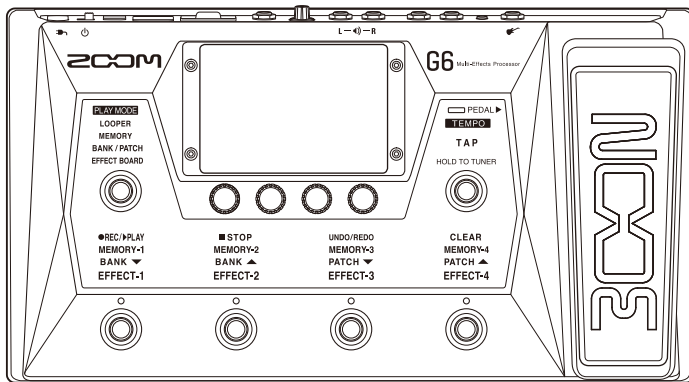

## Quick Guide

You must read the Usage and Safety Precautions before use.



The Operation Manual can be downloaded from the ZOOM website ([www.zoom.jp/docs/g6](http://www.zoom.jp/docs/g6)). This page has files in PDF and ePub formats.

The PDF file format is suitable for printing on paper and reading on a computer.

The ePub format can be read with electronic document readers and is designed for reading on smartphones and tablets.

© 2021 ZOOM CORPORATION

Copying or reprinting this manual in part or in whole without permission is prohibited.

Product names, registered trademarks and company names in this document are the property of their respective companies. Windows® is a trademark or registered trademark of Microsoft® Corporation. Mac and iPadOS are trademarks or registered trademarks of Apple Inc. iOS is a trademark or registered trademark of Cisco Systems, Inc. and used under license. All trademarks and registered trademarks in this document are for identification purposes only and are not intended to infringe on the copyrights of their respective owners.

You might need this manual in the future. Always keep it in a place where you can access it easily. The contents of this manual and the specifications of the product could be changed without notice.

## Functions of parts

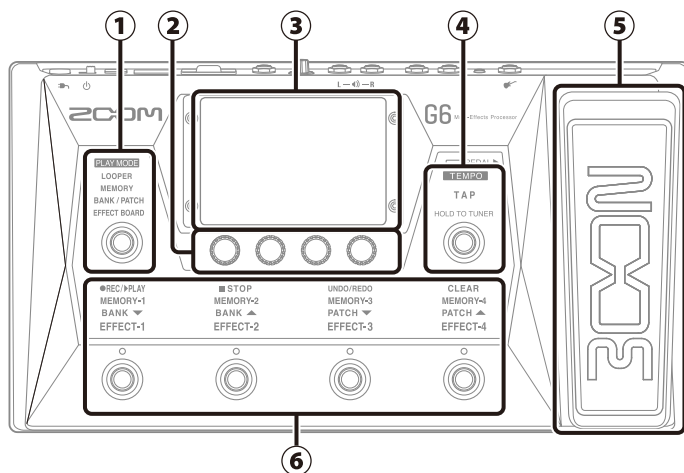

### ① PLAY MODE selection section

Use this to select the **G6** PLAY MODE. (The selected mode lights.)

### ② Parameter knobs

Use these to adjust effect parameters and to make various settings.

### ③ Touchscreen

Operate the touchscreen to select and set patch memories as well as to make **G6** settings, for example.

### ④ TAP switch

Use this to tap the tempo and to turn the tuner on/off.

### ⑤ Expression pedal

Use this pedal to adjust the volume or a wah effect, for example.

### ⑥ Footswitches and their function indicators

Use these to select patch memories and banks, turn effects on and off, and operate the looper. The functions that can be controlled by the footswitches light.

## ■ Play mode overview

The **G6** has four play modes that can be used as needed while performing.

PLAY MODE	Explanation
<b>LOOPER</b>	The looper appears on the touchscreen and can be operated using the footswitches.
<b>MEMORY</b>	Banks and the patch memories in them are shown on the touchscreen, and patch memories can be selected using footswitches.
<b>BANK / PATCH</b>	Patch memory names are shown with large characters on the touchscreen, and banks and patch memories can be selected using footswitches.
<b>EFFECT BOARD</b>	The effects used in a patch memory are shown on the touchscreen, and each effect can be turned on/off using footswitches.

# Making connections

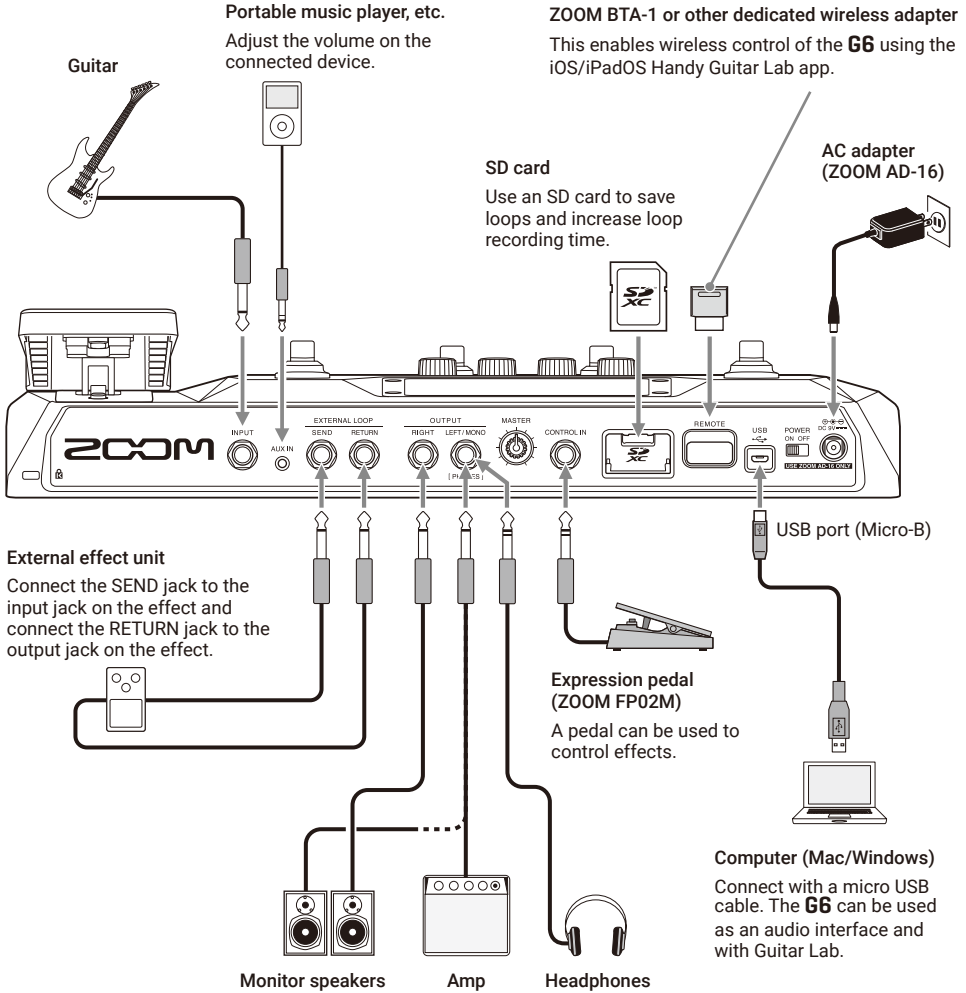

## HINT

- The Guitar Lab computer app can be used to manage patch memories and to edit and add effects. Guitar Lab can be downloaded from the ZOOM website ([zoomcorp.com](http://zoomcorp.com)).
- The **G6** can be controlled remotely using the Handy Guitar Lab iOS/iPadOS app. Handy Guitar Lab can be downloaded from the App Store.

# Memory overview (patch memories/banks)

## Patch memories

These store the effects used, their order, on/off states and parameter setting values. Effects can be saved and recalled in patch memory units. 240 patch memories can be stored.

## Banks

These are groups of 4 patch memories. 60 banks can be stored.

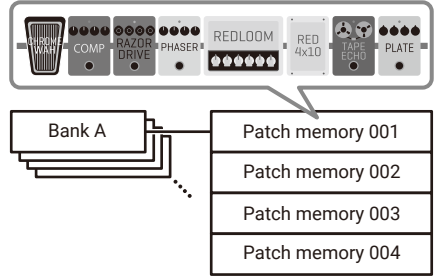

# Signal flow

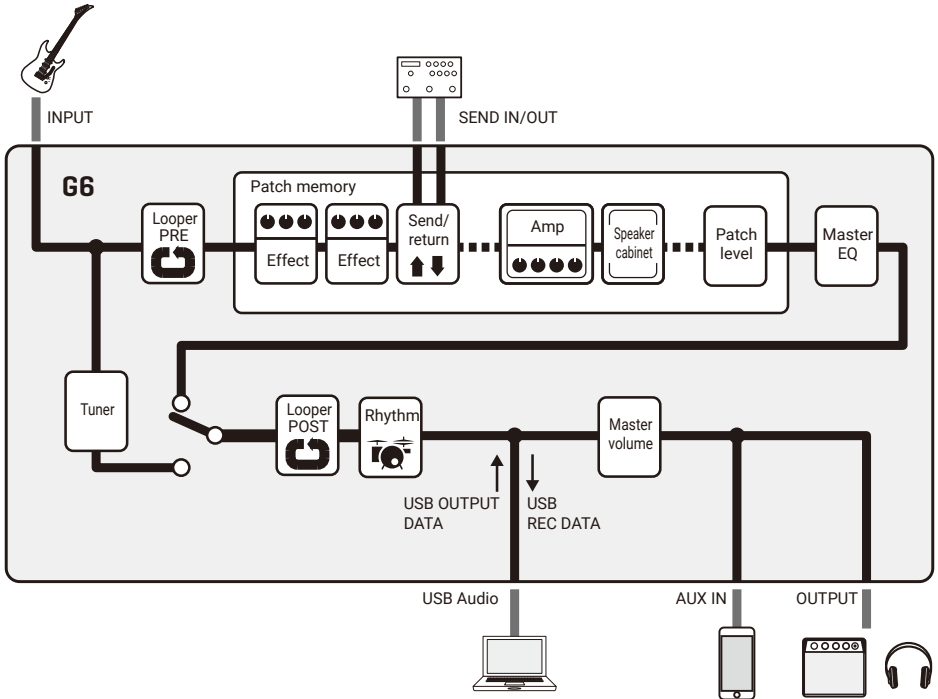

# Using the touchscreen

All the functions are arranged as icons on the Menu Screen, so each one can easily be accessed by touch.

## Opening the Menu Screen

**When a play mode screen is open**  
Swipe down from the toolbar.

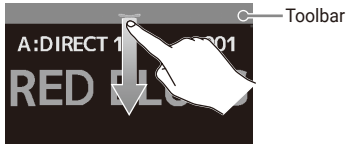

**When a setting screen is open**  
Touch **< BACK** repeatedly.

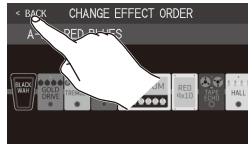

## Using the Menu Screen

Current bank      Current patch memory

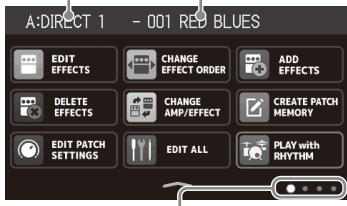

The Menu Screen has four pages. This shows which page is currently open.

Touch an icon to select a function to set or adjust. Icons can be dragged to reorder them.

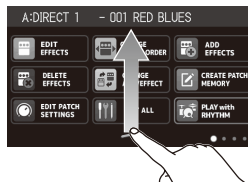
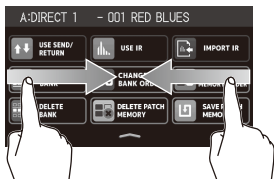

Swipe right from left edge to open previous page.      Swipe left from right edge to open next page.

Swipe up from the bar at the bottom of the Menu Screen to return to the PLAY MODE screen.

## Using other screens

Touch and drag to operate.

Touch an item to select it.

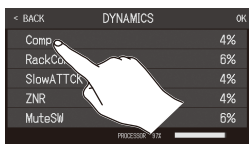

Drag an item to move or adjust it (slide finger left, right, up or down).

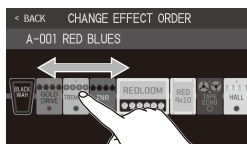

# Turning the power on

1. Minimize the volume of the amp/monitor speakers.

2. Set  to ON.

This turns the **G6** power on and opens the Effect Board Screen on the touchscreen.

3. Raise the volume of the amp/monitor speakers.

### NOTE

By default, ECO mode setting is on, so the power will automatically turn off if no use occurs for 10 hours. ECO mode can also be turned off.

### HINT

When the **G6** power is turned on, the state when the power was last turned off will be restored.

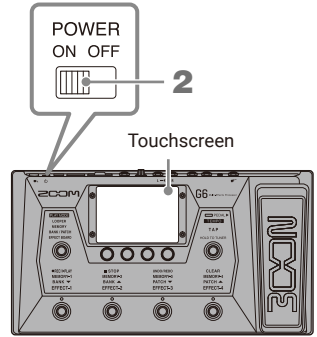



# Adjusting the master level and EQ

## ■ Adjusting the master level

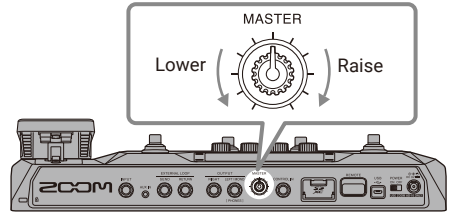
The volume output from the **G6** can be adjusted.



## ■ Adjusting the master EQ

In MEMORY, BANK/PATCH or EFFECT BOARD mode, turn  to open the OUTPUT EQ screen. Turn a  to adjust the quality of the output sound accordingly.

Touch  at the top right of the screen to lock the settings.

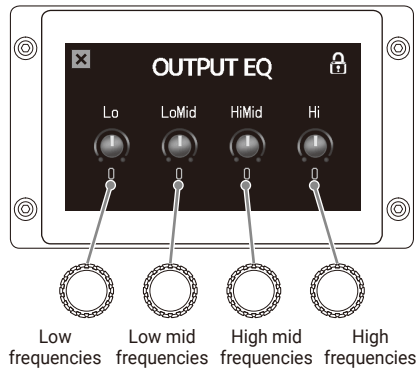

# Turning effects on and off while playing

In EFFECT BOARD mode, the effects and amp used in the patch memory are shown on the touchscreen and can be turned on and off using the footswitches.

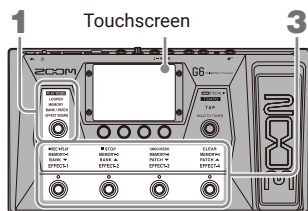

1. Press  repeatedly to select **EFFECT BOARD**.

This puts the **G6** into EFFECT BOARD mode.

2. After touching  at the top right, touch the effect that you want to turn on/off with a footswitch.

That effect is assigned to a footswitch.

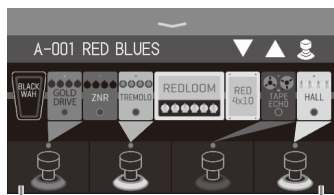

When effects are assigned, the color at the base of the footswitch changes according to the category.

3. Press footswitches to turn effects on/off.

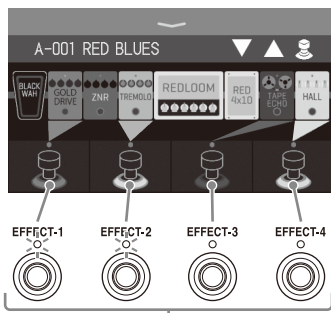

The indicators light when effects are on.

## NOTE

- Regardless of the order that the effects are touched, they are assigned to the footswitches from the left.
- After effects have been assigned to all footswitches, touching other effects will not assign them.
- Touching a footswitch that has an effect assigned to it will remove that assignment.

## HINT

The following operations are also possible on the touchscreen.

Select the previous patch memory.

Select the next patch memory.

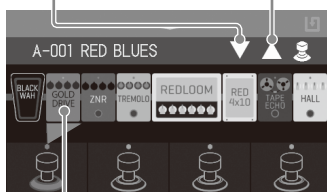

Touch the effect you want to adjust to open the EDIT EFFECTS screen.

## Switching banks and patch memories while playing

In BANK/PATCH mode, patch memory names appear large on the touchscreen. The touchscreen can be swiped to change the patch memory and the footswitches can be used to change banks and patch memories.

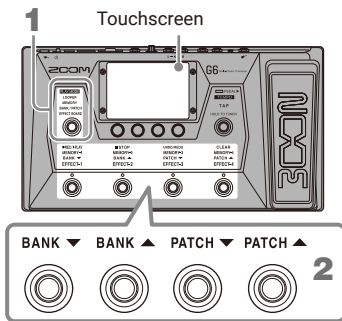

1. Press  repeatedly to select **BANK / PATCH**.

This puts the **G6** into BANK/PATCH mode.

2. Swipe up or down on the touchscreen to select patch memories.

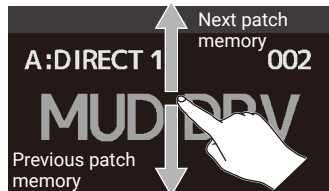

The footswitches can also be used to select banks and patch memories.

## Switching patch memories in one bank while playing

In MEMORY mode, the current bank and the four patch memories in it are shown on the touchscreen, and those patch memories can be selected with one touch.

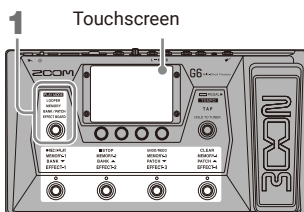

1. Press  repeatedly to select **MEMORY**.

This puts the **G6** into MEMORY mode.

2. Select the bank and patch memory.

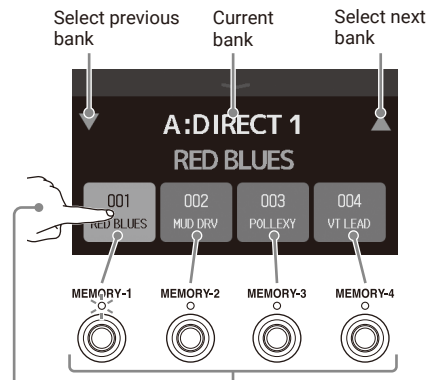

Select a patch memory by touching it or pressing its footswitch.

(The selected patch memory is highlighted and the corresponding indicator lights.)







# Using the looper while playing

Played phrases can be recorded to create stereo loops up to 45 seconds long.

## 1. Press repeatedly to select **LOOPER**.

This puts the **G6** into LOOPER mode.

## 2. Use the looper.

	<b>Press when stopped</b> This starts recording. If a loop has already been recorded, it starts playing back.
	<b>Press when recording</b> Recording stops and the loop plays back.
	<b>Press when playing back</b> This starts overdubbing (recording on top of) the playing loop.
	<b>Press when recording</b> This cancels recording.
	<b>Press when playing back</b> This stops playback.
	This erases the last overdub (UNDO). Press again to restore the erased overdub (REDO).
	This deletes the loop.

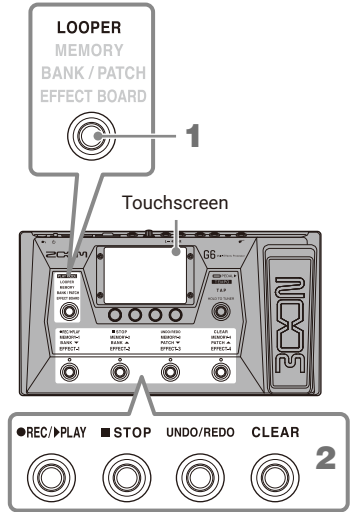

This shows the looper status.

- READY: No loop recorded yet
- REC: Now recording
- PLAY: Playing back
- STOP: Playback stopped
- CLEAR: Loop cleared
- OVERDUB: Now overdubbing
- UNDO: Last recorded overdub erased
- REDO: Overdub erased by UNDO restored



Touch to open the looper settings screen.  
The mono/stereo setting, the stopping method and the looper position can be set.

Adjust the looper volume.

Set the recording time.

### HINT

Using an SD card, loops can be recorded for longer times and saved. Moreover, loops on the SD card can be recalled for playback and overdubbing.

- **MANUAL:** Press  to stop recording.
- **¼ 1-64:** Set the recording time in quarter notes.

# Turning effects on/off and adjusting them

## Turning effects on/off

1. Touch  **EDIT ALL** on the Menu Screen.

This opens the EDIT ALL screen on the touchscreen.

2. Touch the indicator above an effect to turn it on/off.

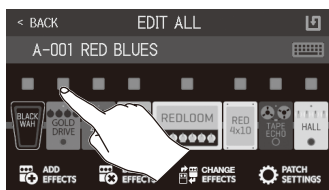

The indicator appears lit red when on and unlit when off.

## Adjusting effects

1. Touch  **EDIT EFFECTS** on the Menu Screen.

This opens the EDIT EFFECTS screen on the touchscreen.

2. Touch the effect to adjust.

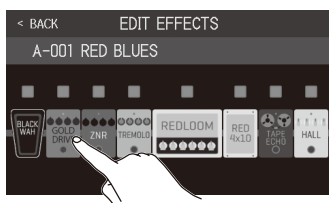

This opens the parameter editing screen on the touchscreen.

3. Turn  to adjust an effect parameter.

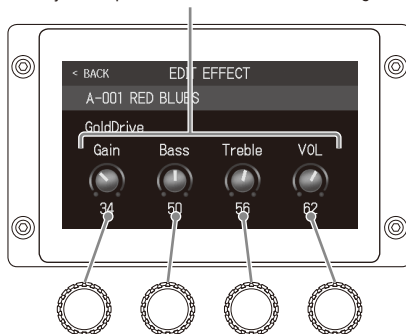

Adjustable parameters and their current settings

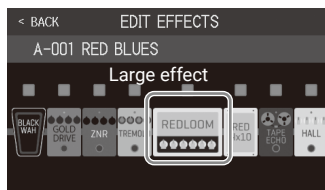

## NOTE

- When the AUTOSAVE function is ON, changes to patch memories will be automatically saved. (This function is ON by default.)
- Effects that look bigger on the EDIT EFFECTS screen are called “large effects” and use two effect spaces.



Large effects have more parameters, so their EDIT EFFECT screens have two pages. Touch  or  at the bottom of the screen to change pages.

## HINT

See Guitar Lab for the explanations of each effect.

## ■ Changing the effect order

1. Touch  on the Menu Screen.

This opens the CHANGE EFFECT ORDER screen on the touchscreen.

2. Drag an effect you want to move.

This moves the effect.

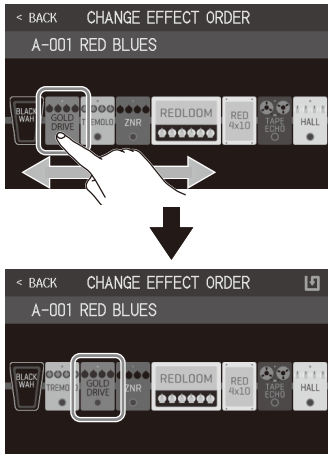

## ■ Adding effects

1. Touch  on the Menu Screen.

This opens the ADD EFFECTS screen on the touchscreen.

2. Drag  to the position where you want to add the effect.

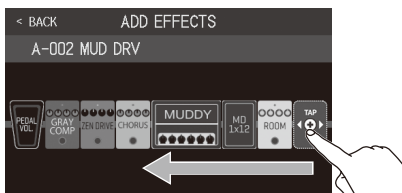

## NOTE

If the maximum number of effects are in use,  will not be shown.

3. Touch .

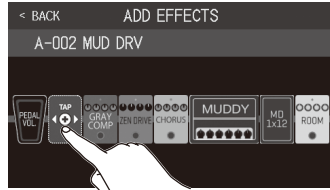

4. Touch a category to select it.

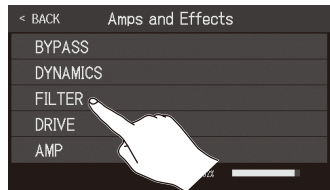

5. Touch an effect type to select it. Then, touch OK.

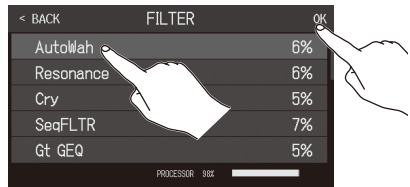

This adds the effect.



## NOTE

Using the **GG6**, 9 effects can be combined freely. If the processing capability limit is exceeded, however, a "PROCESS OVERFLOW" warning will appear on the touchscreen and effects will be bypassed. Change or remove one of the effects to end this condition. The processing status can be checked on screens where categories and effects are selected.

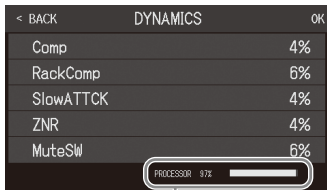

Processing status

## Deleting effects

1. Touch  on the Menu Screen.

This opens the DELETE EFFECTS screen on the touchscreen.

2. Touch the  for the effect to delete it.



That effect will be deleted.

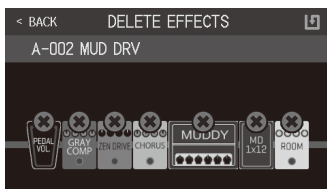

## Changing effects

1. Touch  on the Menu Screen.

This opens the CHANGE AMP/EFFECTS screen on the touchscreen.

2. Touch the effect that you want to change.

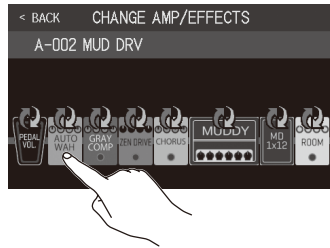

3. Touch an effect type to select it. Then, touch OK.

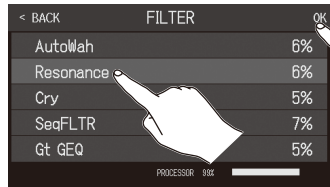

That effect will be changed.

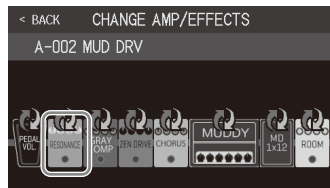



## HINT

- To change to an effect in another category, touch BACK, select the category and then select the effect.
- See Guitar Lab for the explanations of each effect.

## Using the tuner

Use this to tune the connected guitar.

1. Touch  on the Menu Screen or press and hold .

This opens the tuner on the touchscreen.

2. Play the open string that you want to tune and adjust its pitch.

Touch to mute the sound.



This shows the tuner type and standard pitch. Touch this to open the tuner settings screen where additional settings can be made.

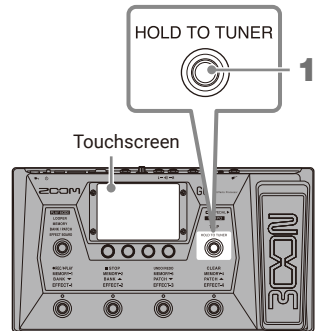

- The nearest note name and pitch detuning will be shown.
- When the pitch is accurate, the left and right indicators will become green.
- Different tuner types can be shown by swiping right and left.

## Using the pedal

If an effect in the PEDAL category is selected in a patch memory, the amount of the effect can be controlled with the expression pedal.

Pressing the front of the pedal turns the pedal effect on/off.

(When on, the pedal indicator lights.)

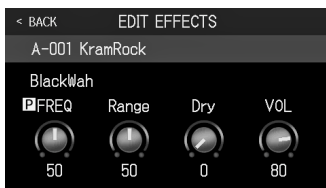

To check the parameter adjusted by the pedal, touch  on the Menu Screen to open the EDIT EFFECTS screen and touch the PEDAL effect.

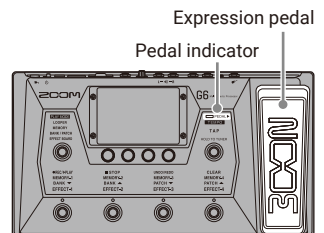

### HINT

When an external pedal is connected, two effects from the PEDAL category can be used.

# Using rhythms

You can play along with built-in rhythms.

1. Touch  **PLAY with RHYTHM** on the Menu Screen.

This opens the PLAY with RHYTHM screen on the touchscreen.

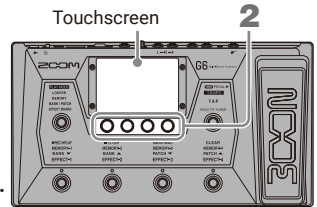

2. Make rhythm settings on the PLAY with RHYTHM screen.

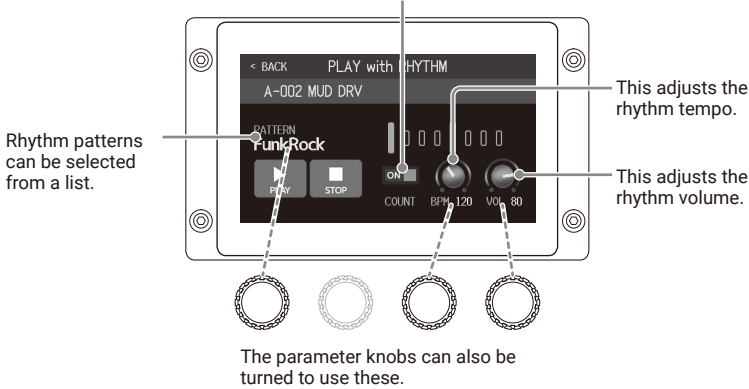

Use to turn the count on/off when recording with the looper.



3. Start/stop rhythm playback.

- Start playing: Touch 
- Stop playing: Touch 

## Rhythm patterns

No.	Pattern name	Time Sig.
1	GUIDE	4/4
2	8Beats1	4/4
3	8Beats2	4/4
4	8Beats3	4/4
5	16Beats1	4/4
6	16Beats2	4/4
7	16Beats3	4/4
8	Rock1	4/4
9	Rock2	4/4
10	Rock3	4/4
11	ROCKABLY	4/4
12	R'n'R	4/4
13	HardRock	4/4
14	HeavyMtl	4/4
15	MtlCore	4/4
16	Punk	4/4
17	FastPunk	4/4

No.	Pattern name	Time Sig.
18	Emo	4/4
19	TomTomBt	4/4
20	Funk1	4/4
21	Funk2	4/4
22	FunkRock	4/4
23	JazzFunk	4/4
24	R&B1	4/4
25	R&B2	4/4
26	70's Soul	4/4
27	90's Soul	4/4
28	Motown	4/4
29	HipHop	4/4
30	Disco	4/4
31	Pop	4/4
32	PopRock	4/4
33	IndiePop	4/4
34	EuroPop	4/4

No.	Pattern name	Time Sig.
35	NewWave	4/4
36	OneDrop	4/4
37	Steppers	4/4
38	Rockers	4/4
39	Ska	4/4
40	2nd Line	4/4
41	Country	4/4
42	Shuffle1	4/4
43	Shuffle2	4/4
44	Blues1	4/4
45	Blues2	4/4
46	Jazz1	4/4
47	Jazz2	4/4
48	Fusion	4/4
49	Swing1	4/4
50	Swing2	4/4
51	Bossa1	4/4

No.	Pattern name	Time Sig.
52	Bossa2	4/4
53	Samba1	4/4
54	Samba2	4/4
55	Breaks1	4/4
56	Breaks2	4/4
57	Breaks3	4/4
58	12/8 Grv	12/8
59	Waltz	3/4
60	JzWaltz1	3/4
61	JzWaltz2	3/4
62	CtWaltz1	3/4
63	CtWaltz2	3/4
64	5/4 Grv	5/4
65	Metro3	3/4
66	Metro4	4/4
67	Metro5	5/4
68	Metro	

# Setting list

This is a list of the functions shown when Menu Screen icons are touched.

Icon	Explanation
EDIT EFFECTS	Adjust effect parameters.
CHANGE EFFECT ORDER	Change the order of effects in patch memories.
ADD EFFECTS	Add effects to patch memories.
DELETE EFFECTS	Remove effects from patch memories.
CHANGE AMP/EFFECT	Change effects and amps in patch memories.
CREATE PATCH MEMORY	Create patch memories.
EDIT PATCH SETTINGS	Set patch memory names and levels.
EDIT ALL	Edit all patch memory settings.
PLAY with RHYTHM	Use the rhythm function.
USE SEND/RETURN	Make send/return settings.
USE IR	Use impulse responses (IR).
IMPORT IR	Load impulse response (IR) data.
CREATE BANK	Create banks.
CHANGE BANK ORDER	Change the order of banks.
CHANGE PATCH MEMORY ORDER	Change the order of patch memories.
DELETE BANK	Delete banks.
DELETE PATCH MEMORY	Delete patch memories.
SAVE PATCH MEMORY	Save patch memories.
SET SYSTEM SETTINGS	Change and check system settings.
SET TEMPO	Set the tempo used for the effects, rhythms and looper.
SET USB AUDIO	Make USB audio settings.
SET AUTO SAVE	Turn the automatic saving function on/off.
SET POWER/DISPLAY	Adjust the touchscreen brightness and turn ECO mode on/off.
SET PEDAL	Make specific pedal settings.
SET TUNER	Make specific tuner settings.
USE TUNER	Use the tuner.
SET OUTPUT EQ	Adjust the quality of the output sound.
PLAY MODE BANK/PATCH	Show patch memory names in large characters for selection on touchscreen.
PLAY MODE EFFECT BOARD	Show the effects used in the patch memory on the touchscreen.
PLAY MODE MEMORY	Use the footswitches to select the four patch memories in the bank.
PLAY MODE LOOPER	Use the looper.
SET PRESELECT	Turn the preselect function on/off.

See the Operation Manual for detailed information about all the functions.



**ZOOM CORPORATION**

4-4-3 Kanda-surugadai, Chiyoda-ku, Tokyo 101-0062 Japan  
[zoomcorp.com](http://zoomcorp.com)